

VOCSN

Clinical and Technical Manual

Software Versions 4.06 to 5.01



VOCSN offers mechanical **V**entilation, **O**xygen, **C**ough, **S**uction, and **N**ebulizer therapies in one compact, portable, lightweight device.



VENTILATION

Critical Care Ventilator

VOCSN is one of the few portable ventilators to achieve the rigorous critical care standard¹ for safety and accuracy. The ventilator provides invasive, noninvasive, and mouthpiece ventilation and delivers a comprehensive set of modes and settings to meet patient needs.

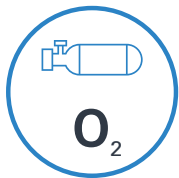

OXYGEN

6 L/min Equivalent Internal Oxygen Concentrator

The VOCSN internal oxygen concentrator and Oxygen Direct™ system deliver the equivalent of 6 L/min of oxygen or up to 40% FiO₂. External high pressure and low pressure oxygen sources can be connected when needed.

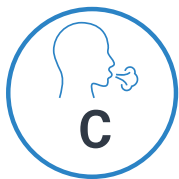

COUGH

Integrated Cough Assistive Therapy™ (ICAT™)

Integrated Cough Assistive Therapy (ICAT) is activated in seconds rather than minutes, without changing the circuit. Breath Sync monitors patient breathing and triggers a cough at a natural point in the breathing cycle.

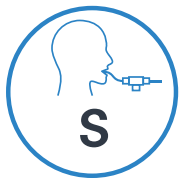

SUCTION

Hospital Grade Suction

Hospital grade suction system provides consistent high flows throughout the entire suction experience. VOCSN Suction therapy is up to three times quieter than traditional portable suction machines.

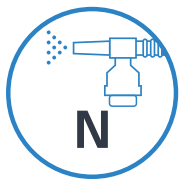

NEBULIZER

High Performance Nebulizer

VOCSN automatically compensates for the airflow from the nebulizer drive to ensure accurate ventilation and comfortable breathing. VOCSN records each medication use and turns off the nebulizer when the therapy is complete.

Copyright: © 2022, Ventec Life Systems
22002 26th Ave SE
Bothell, WA 98021 USA

Part Number: LBL-00001-001, Rev AA

CAUTION: Federal law restricts this device to sale and use by or on the order of a physician.

¹ ISO 80601-2-12

Table of Contents

Introduction	11
Therapy Overview	11
VOCSN Configurations	12
Leak+ Performance	12
Ventilation	13
Oxygen Direct	13
Integrated Cough Assistive Therapy (ICAT)	14
Suction	14
Nebulization	14
Portability	15
Indications for Use	15
VOCSN Training	15
Suggested Environments of Use	16
Home Environments	16
Hospital Environments	16
Institutional Environments	16
Transport Environments	16
Getting Started	17
Package Contents	17
Contraindications	17
System Overview	18

Setup	19
VOCSN Placement	20
Power Setup	21
The Power Supply	22
The Optional 24 Volt Wheelchair Power Cable	23
The Removable, Rechargeable Batteries	23
Ventec One-Circuit Setup	24
Using a Trach, ET Tube, or Non-Vented Mask	25

Using a Vented Mask	25
Using a High Flow Nasal Cannula	25
Connecting an Active, Passive, or Valveless Ventec One-Circuit	26
Ventec One-Circuit Component Connection Order	27
Connecting an External Bacterial Filter	28
Connecting a Ventec One-Circuit Without a Humidifier	28
Connecting a Humidifier and Heated Wire Ventec One-Circuit	29
Connecting a Ventec One-Circuit to a Humidifier (Without the Ventec Humidifier Bypass)	30
Connecting a Ventec One-Circuit, Humidifier, and Ventec Humidifier Bypass	31
Connecting a Ventec One-Circuit O2 Tube	32
Connecting an Active Ventec One-Circuit	33
Connecting an Exhalation Bacterial Filter	34
Connecting Ventec One-Circuit Components	35
Connecting an HME (Heat-Moisture Exchanger)	35
Connecting a Nebulizer Cup to the Patient Circuit	36
Connecting a Closed-Suction Catheter to the Patient Circuit	38
Setting up Ventilation therapy with a Speaking Valve	38
Mouthpiece Patient Circuit Setup	39
Oxygen Therapy Setup	40
Setting Up the Internal O2 Concentrator	41
Setting Up External Oxygen Sources	41
Connecting External High-Pressure Oxygen	42
Connecting External Low-Pressure Oxygen	43
Suction Setup	44
Removing and Reattaching the VOCSN Suction Cap	44
Connecting the Ventec Travel Suction Canister	45
Connecting Suction Tubing to the Travel Canister	46
Connecting the External Suction Canister Adapter	47
Connecting Suction Tubing to Suction Interfaces	47
Connecting a Nurse Call System or Remote Alarm	48
Connecting a React DataLink™	49
Running the Pre-Use Test	50

Breath Types and Therapy Modes

51

Breath Types	51
Pressure Breaths	52
Volume Breaths	53
Spontaneous Breaths	53
VOCSN Ventilation Modes	54
Bi-Level Mode	54
Assist/Control-Pressure with an Active, Passive, or Valveless Ventec One-Circuit	55
Assist/Control-Pressure with a Mouthpiece Patient Circuit	55
SIMV-Pressure Mode	56
CPAP Function	56

High Flow Therapy	56
Assist/Control-Volume Mode	57
Assist/Control-Volume with an Active, Passive, or Valveless Ventec One-Circuit	57
Assist/Control-Volume with a Mouthpiece Patient Circuit	57
SIMV-Volume Mode	58
CPAP Function	58
High Flow Therapy	58
Volume Targeted Ventilation Overview	59
Vol. Targeted-PS Mode	60
Vol. Targeted-PS with an Active, Passive, or Valveless Ventec One-Circuit	60
Vol. Targeted-PS with a Mouthpiece Patient Circuit	60
Vol. Targeted-PC Mode	61
Vol. Targeted-PC with an Active, Passive, or Valveless Ventec One-Circuit	61
Assist/Control-Pressure with a Mouthpiece Patient Circuit	61
Vol. Targeted-SIMV Mode	62
Comparable Volume Ventilation Modes	63
Comparable Pressure Ventilation Modes (Including Volume-Targeted Ventilation)	64
Comparable Non-Invasive Ventilation Modes	65

The Touchscreen

66

Locking the Touchscreen	66
Quick View	66
The Status Bar	67
The Home Screen	68
Night Mode and Day Mode	68
The Therapy Screen	69
The Monitors Screen	70
The Customization Button	70
The Waveforms Button	70
The Menu Screen	71
The Pre-Use Test Button	71
The Settings & Alarms Button	72
The Device Settings Button	72
The Logs Button	72
The Clinician Access Button	72
The Enable Prescribed Therapies Button	73
The Permissions Button	73
The My VOCSN Button	73

Controls and Settings

74

Ventilation Therapy Controls	75
Changing Ventilation Therapy Settings	75
Available Ventilation Therapy Settings	76

Control Limiting	83
Controls Available in Each Ventilation Mode	84
Setting VOCSN Controls for Mouthpiece Ventilation	87
Setting VOCSN Controls for High Flow Therapy	87
Enabling and Disabling Prescribed Therapies	88
Oxygen Controls	90
Changing Oxygen Settings	90
Available Oxygen Settings	91
Cough Therapy Controls	93
Changing Cough Therapy Settings	93
Available Cough Therapy Settings	94
Changing Suction Settings	96
Changing Nebulizer Settings	97
Clinician Access Mode	98
Entering the Clinician Access Passcode	98
Configuring Permissions	99
Device Settings	100
Changing Device Settings	100
Available Device Settings	101
VOCSN Therapy Interactions	102

Alarms

103

Alarm Silence Button	104
Changing Alarm Settings	104
Alarm Conditions and Settings	105
The Alarm Log	114
The Mark Event Button	114
The Event Log	115
Clearing an Alarm	116
Remote Alarms and Nurse Call Systems (Optional)	116

Monitors

118

Ventilation Monitors	119
Waveform Monitors	121
Monitor Screen Customization	122
Oxygen Therapy Monitors	123
FiO2 Monitor	123
Calculated FiO2 Monitor	124
Cough Therapy Monitors	125
Suction Therapy Monitor	126
Nebulizer Therapy Monitor	127
System Monitors	128

Multi-View 129

- Exporting Multi-View Data to a USB Drive130
- Generating Multi-View Reports131
- Reading Multi-View Reports132
 - Report Information132
 - Trend Summary133
 - Compliance Calendar133
 - Therapy Use134
 - Settings Overview134
 - Monitor Details135
 - Logs136

Checkout Procedure 137

- Visual Inspections137
- Inop Alarm Test137
- Power Testing Procedures138
- Ventilation and Oxygen Testing Procedures139
 - Ventilation And Oxygen Tests140
 - Ventilation Alarm Verification141
 - Remote Alarm Test (Optional)141
 - Decannulation Alarm Verification142
 - Patient Circuit Disconnect Alarm Verification142
- Cough Therapy Testing Procedures143
- Suction Therapy Testing Procedures144
- Nebulizer Therapy Testing Procedures144
- Configure and Verify Control and Alarm Settings144
- Checkout Worksheet145

Operating Instructions 146

- Powering On VOCSN147
- Starting VOCSN Therapies148
 - Starting Ventilation Therapy149
 - Changing Between Configured Ventilation Presets150
 - Starting Oxygen Therapy151
 - Using O2 Flush152
 - Using the Internal O2 Concentrator to Provide Pulse Dose Oxygen Direct Therapy153
 - Using External High-Pressure Oxygen154
 - Using External Low-Pressure Oxygen154
 - Starting Cough Therapy155
 - Starting Suction Therapy156
 - Starting Nebulizer therapy158
- Responding to Alarms160
- Powering Off VOCSN160

Cleaning and Maintenance 161

Cleaning VOCSN	161
Cleaning VOCSN Exterior	162
Cleaning the Air and Fan Filters	163
Replacing Components	164
Emptying the Ventec Travel Suction Canister and Replacing Suction Components	164
Replacing the Power Supply	165
Replacing the Ventec One-Circuit or Ventec Humidifier Bypass	165
Replacing Ventec One-Circuit Components	166
Replacing the Nebulizer Filter	166
Replacing the External Bacterial Filter	166
Replacing the Internal Bacterial Filter	167
Recommended Maintenance Schedule	168
Battery Care, Maintenance, and Replacement	169
Battery Storage Mode	170
Software Updates	171
Locating the VOCSN Software Version	173
Environmental Considerations	173
Shipping Considerations	173

Glossary 174

Glossary of Symbols	174
Glossary of Indicators	178
Glossary of Terms	180

Troubleshooting 181

Troubleshooting Alarms	181
Device Troubleshooting	187
Ventilation and Cough Troubleshooting	188
Oxygen Troubleshooting	189
Suction Troubleshooting	190
Nebulizer Troubleshooting	190
Multi-View Troubleshooting	191
Patient Circuit Troubleshooting	191
Recalibrating Batteries	192

Technical Specifications 193

Physical	193
Environmental	194
Inputs and Outputs	194
External Power Requirements	195
Removable, Rechargeable Batteries	195

Internal Rechargeable Battery	195
Expected Service Life and Intervals	196
Audible Volume	196
O2 Concentrator	196
Nebulizer Drive	197
FiO2 Monitor	197
Control Accuracy	198
Monitor Resolution and Accuracy	200
Classifications	202
Standards Applied	202
Ventec One-Circuit Compliance	203
Pressure During Inop	203
Biocompatibility	203

Accessories

204

Available from Ventec Life Systems	204
Available from Other Manufacturers	209

EMC Information

210

Electromagnetic Emissions	211
Electromagnetic Immunity	212
Recommended Separation Distance Between Portable and Mobile RF Communications Equipment and VOCSN	214

Technical Description

215

Theory of Operation	215
Ventilation Therapy and FiO2 Oxygen Therapy	215
Leak Compensation	216
Leak Compensation with an Active Ventec One-Circuit	216
Leak Compensation with a Passive or Valveless Ventec One-Circuit	217
Leak Compensation with a Mouthpiece Circuit	217
The Oxygen Direct System	218
Integrated Cough Assistive Therapy (ICAT) and the Ventec Humidifier Bypass	219
Suction	219
Nebulization	220
Internal Nebulizer Therapy	220
External Nebulizer Compensation	220
VOCSN Measurements	221
Airway Pressure Measurements	221
Flow Measurements	221
Volume Measurements	221
FiO2 Measurements	221

Alarm Detection Criteria	222
System Fault Detection Criteria and Recommended Action	223
Low-Pressure Oxygen Blending	225
Input Flow 100% Oxygen, Flow Trigger Set to 1-3	226
Input Flow 100% Oxygen, Flow Trigger Set to 9	226
Input Flow 93% Oxygen, Flow Trigger Set to 1-3	227
Input Flow 93% Oxygen, Flow Trigger Set to 9	227
Input Flow 100% Oxygen, High Flow Therapy	228
Input Flow 93% Oxygen, High Flow Therapy	228

Introduction

Therapy Overview

Using the Ventec One-Circuit®, clinicians, home caregivers, and patients can use VOCSN to ventilate, provide air enriched with oxygen to the patient, simulate natural coughs to clear secretions, remove those secretions from the patient airway or circuit, and administer nebulized medication, minimizing the need to connect additional medical equipment or reconfigure the patient circuit.



VENTILATION

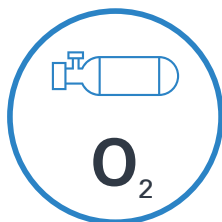

OXYGEN

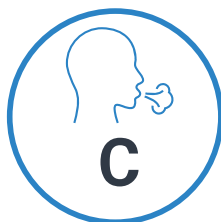

COUGH

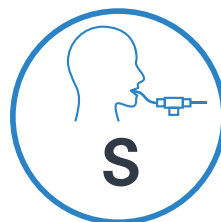

SUCTION

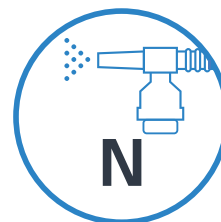

NEBULIZER

NOTE: This manual describes the features included with software versions 4.06 to 5.01. Not all functionality is available in previous versions of the VOCSN software. See “Software Updates” on page 171 for a description of features included in each release, and instructions to check the software version of your device. To view revisions of the Clinical and Technical manual associated with previous software versions, see VentecLife.com/resources.

VOCSN Configurations

VOCSN offers mechanical Ventilation, Oxygen, Cough, Suction, and Nebulizer therapies in one compact, portable, lightweight device. VOCSN is customizable and may be purchased in various configurations of the available integrated therapies. There are many possible VOCSN configurations. This allows patients and caregivers to select a device that provides therapies that meet the patient’s individual needs.

Your device may include all five therapies and all the features described in this manual, or just the set of therapies and features purchased or prescribed by the treating physician. Depending on its configuration, VOCSN will be able to provide **V**entilation, **+O**xygen Concentration, **+C**ough, **+S**uction, and/or **+N**ebulizer therapy. It may also be able to provide oxygen from an external high-pressure source and FiO2 monitoring (**+Pro** configurations) or low-pressure oxygen (all configurations). The configuration name is based on the therapies VOCSN can provide. For example, the **V+C** configuration provides **V**entilation**+C**ough therapies. The configuration name is printed on the back of the device, and is also visible on the [My VOCSN](#) screen.

Configuration (Located on Device Rear Label)	Ventilation (V)	O2 Concentration (+O)	Cough (+C)	Suction (+S)	Nebulizer +N)	High-Pressure External Oxygen and FiO2 Monitor (+Pro)	Low-Pressure External Oxygen
V+O+C+S+N+Pro (or "VOCSN")	Yes	Yes	Yes	Yes	Yes	Yes	Yes
V+O+C+S+N	Yes	Yes	Yes	Yes	Yes	No	Yes
V+C+S+N+Pro	Yes	No	Yes	Yes	Yes	Yes	Yes
V+C+Pro (or "VOCSN-VC")	Yes	No	Yes	No	No	Yes	Yes
V+C	Yes	No	Yes	No	No	No	Yes
V+Pro and V+Pro Emergency	Yes	No	No	No	No	Yes	Yes

Leak+ Performance

The **Leak+** feature allows VOCSN to deliver **High Flow ventilation, as well as provide compensation for leaks up to 175 L/min at 20 cmH2O**. The improved Leak Compensation may be particularly useful during non-invasive ventilation. Leak+ is available on devices with compatible hardware running software version 4.06R and newer.

To see if your VOCSN is capable of Leak+ performance, install the latest software and check for the "V" icon with a white background in the status bar. The availability of this feature can also be found on the [My VOCSN](#) screen next to "Leak+."



For more information about VOCSN leak compensation, see *"Leak Compensation" on page 216*.

WARNING: Delivered and monitored ventilation therapy may be affected by large leaks around the patient interface.

Ventilation

VOCSN provides invasive or non-invasive ventilation. Using one of six ventilation modes, and an active, passive, valveless, or mouthpiece Ventec One-Circuit, VOCSN delivers configurable pressure, volume, and/or spontaneous breaths.

The configurable Flow Trigger control, in combination with the powerful integrated Leak Compensation feature, allows VOCSN to perform well for both invasive and non-invasive applications, even with significant leaks in the patient circuit. VOCSN devices with the Leak+ feature can compensate for leaks up to 175 L/min at 20 cmH₂O. Ventilation controls such as Rise Time and Pressure Control Flow Termination can be adjusted to improve patient comfort.

The Ventilation therapy Presets feature allows clinicians to set up, label, and store up to three unique Ventilation therapy configurations. Using the touchscreen, clinicians, home caregivers, and patients can switch between these three pre-configured therapies as needed. For example, some patients may benefit from one ventilation Preset while awake, another Preset while active, and a third Preset during sleep.

The Permissions feature allows clinicians to lock VOCSN control settings. VOCSN controls can be set to User and Clinician, or Clinician Only. Controls set to Clinician Only cannot be modified until the Clinician Access Passcode is entered. Controls set to User and Clinician will remain adjustable at all times.

Optional integrated oxygen blending provides a configurable FiO₂ to the patient, utilizing an external high-pressure oxygen source. The internal FiO₂ monitor continuously monitors the FiO₂ of the delivered gas as it flows to the Ventec One-Circuit, to ensure the accuracy of delivered Oxygen therapy. The VOCSN also includes an internal O₂ Concentrator, which may be used to provide Oxygen Direct™ therapy to the patient. Alternatively, oxygen can be flowed into the Ventec One-Circuit through the low-pressure oxygen port.

Oxygen Direct

The VOCSN internal O₂ Concentrator delivers Oxygen Direct therapy to the patient without requiring an external oxygen source. It is intended for the administration of non-life-sustaining, supplemental oxygen to stable individuals. Using the O₂ Flow Equivalent control, the internal O₂ Concentrator delivers the equivalent of up to 6 L/min as pulse doses through a small integrated oxygen tube in the Ventec One-Circuit.

Traditional, portable oxygen concentrators include a pulse dose oxygen mode, used to deliver oxygen through a high flow nasal cannula, but do not have a way to trigger pulsed doses of oxygen through a patient circuit for ventilation. VOCSN unifies ventilation and oxygen concentration to deliver oxygen as pulse doses through a small oxygen tube in the Ventec One-Circuit, in synchronization with patient breathing.

VOCSN can also be connected to an external source of high-pressure oxygen to deliver oxygen through the Ventec One-Circuit as a configured FiO₂, or in pulse dose mode using an integrated Ventec One-Circuit O₂ tube.

Integrated Cough Assistive Therapy (ICAT)

Integrated Cough Assistive Therapy (ICAT)TM can be delivered with the touch of a button without modifying the Ventec One-Circuit. Once initiated using the touchscreen, VOCSN transitions to Cough therapy and then back to Ventilation therapy automatically. Integrated Cough Assistive Therapy (ICAT) delivers an insufflation (positive) pressure, and then an exsufflation (negative) pressure through the Ventec One-Circuit to simulate a natural cough, moving secretions out of the patient airway.

The Cough+Suction feature allows VOCSN to activate Suction therapy automatically when Cough therapy is initiated, to simultaneously move secretions out of the patient airway, and from the Ventec One-Circuit.

The Breath Sync feature synchronizes cough maneuvers with patient effort to improve patient comfort. VOCSN also monitors Peak Cough Flow and Cough Volume to help ensure Cough therapy is delivered effectively.

Suction

VOCSN includes a high-flow suction system designed to safely aid in effective airway clearance for both pediatric and adult patients. If enabled, Suction therapy can be initiated at any time during Ventilation or Cough therapy, to help remove secretions from the patient airway or Ventec One-Circuit.

The Cough+Suction feature allows VOCSN to activate Suction therapy automatically when Cough therapy is initiated, to simultaneously move secretions out of the patient airway, and from the Ventec One-Circuit.

Suction therapy can be used with a Ventec Secretion Trap, or closed- or open-suction catheter. The Ventec Secretion Trap collects secretions as they enter the Ventec One-Circuit during Cough therapy. Suction tubing connected to the Ventec Secretion Trap vacuums those secretions out of the Ventec One-Circuit and into the detachable Ventec Travel Suction Canister.

Nebulization

Optional Nebulizer therapy provides an integrated 6 L/min nebulizer drive, to power a nebulizer connected to the Ventec One-Circuit. Nebulization can be initiated using the VOCSN touchscreen, and turns off automatically when the configured Nebulizer therapy duration has elapsed. While Nebulizer therapy is active, VOCSN automatically adjusts the delivered Ventilation therapy to compensate for nebulization flows.

Portability

VOCSN is designed to support the transport of mechanically ventilated patients. VOCSN includes two removable, rechargeable batteries and an internal rechargeable battery, used to power the device when no external source of continuous power is available.

Using the power supply, VOCSN can be connected to a wall outlet or other AC power source. Ventec Life Systems also offers an optional 24 Volt Wheelchair Power Cable, which can be used to power VOCSN from wheelchair outlets. VOCSN batteries charge whenever an external power source is applied.

Indications for Use

VOCSN Unified Respiratory System is intended to provide continuous or intermittent ventilatory support for the care of individuals who require mechanical ventilation. It may be used in invasive and non-invasive applications. VOCSN is intended for pediatric through adult patients weighing at least 5 kg. It is intended for use in home, hospital, institutional, and transport settings, including portable applications.

The integral oxygen concentrator is intended for the administration of supplemental oxygen. The integral suction pump is intended for airway fluid removal and oral/pharyngeal hygiene. The integral cough assist option is intended for patients who are additionally unable to cough or clear secretions effectively.

VOCSN Training

The VOCSN clinician or caregiver must be capable of responding to alarm conditions, and trained to use VOCSN. A list of available VOCSN training options is available at VentecLife.com.

CAUTION: Clinicians responsible for configuring and operating VOCSN must be trained to use it and should review this manual in its entirety before using VOCSN to administer therapy. Home caregivers must also receive training, and must review the Home Caregiver and Patient Guide (available at VentecLife.com) prior to setting up or operating VOCSN.

Suggested Environments of Use

VOCSN is suitable for use in the following environments:

Home Environments

- Home care
- Home-based transport

Hospital Environments

- Emergency departments
- Step-down units
- Military hospitals

WARNING: Do not use VOCSN within magnetic resonance (MR) environments. Using VOCSN within MR environments may affect VOCSN or MR device performance, damage the devices, or harm individuals.

Institutional Environments

- Long-term acute care
- Skilled nursing facilities
- Long-term care/nursing homes

Transport Environments

- Intra-hospital transport
- Inter-hospital transport
- Emergency medical services
- Military transport

NOTE: VOCSN that include an airplane symbol on the back label are compliant with the regulations for device use on board aircraft.



Getting Started

Package Contents

VOCSN includes the following items:

- One VOCSN (therapy configuration may vary)
- Two removable, rechargeable batteries
- One power supply
- One Ventec One-Circuit
- Bacterial filters
- One Quick Start Guide
- One Ventec Travel Suction Canister (included with VOCSN configurations with Suction therapy)
- One Nebulizer Filter (included with VOCSN configurations with Nebulizer therapy)

NOTE: Contact Ventec Life Systems at 1-844-MY-VOCSN for assistance with setup, maintenance, or to report unexpected device operation.

See *"Accessories" on page 204* for a list of VOCSN components and accessories available from Ventec Life Systems.

Contraindications

Consult the patient's healthcare professional before using a non-invasive interface with VOCSN if the patient experiences any of the following medical conditions:

- Inability to maintain a patent airway
- Risk of aspirating gastric contents
- Epistaxis that causes pulmonary aspiration of blood
- Acute sinusitis or otitis media
- Hypotension

Consult the patient's healthcare professional before using Cough therapy if the patient experiences any of the following medical conditions:

- A medical history of bullous emphysema
- Recent barotrauma
- Susceptible to pneumothorax or pneumo-mediastinum

System Overview

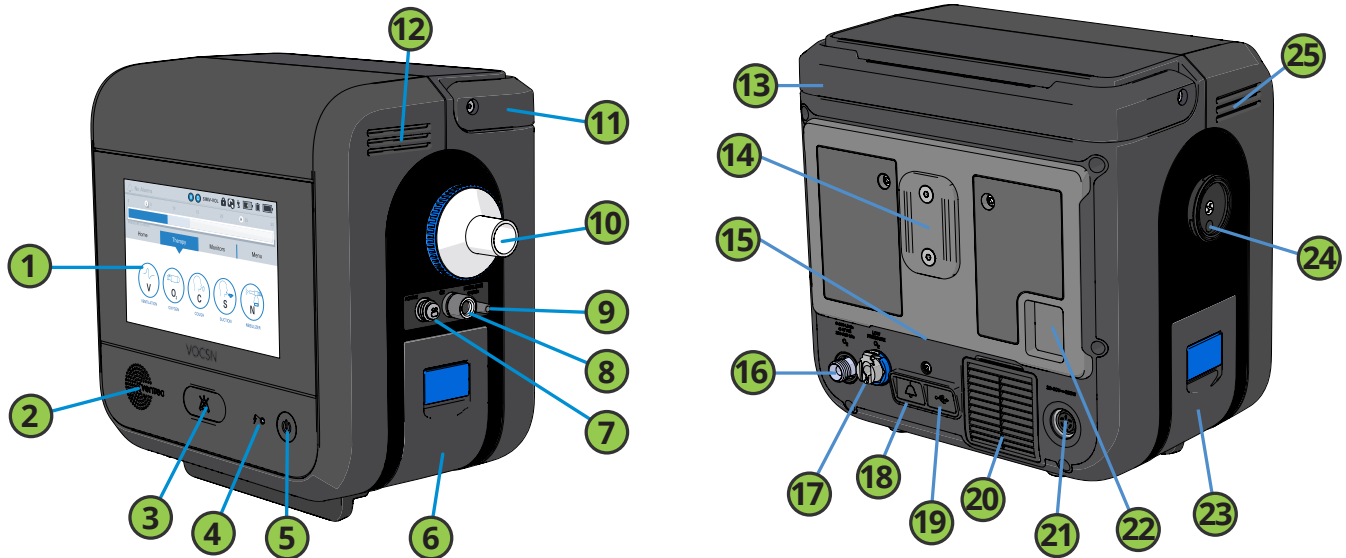

Description		Description	
1	Touchscreen	13	Handle (back view)
2	Speaker	14	T-Slot mount
3	Alarm Silence button	15	Cooling air outlet and Cough therapy exhaust
4	External Power / Charge Status indicator light	16	High-pressure O2 Inlet (+Pro configurations only)
5	On/Off button and indicator light	17	Low-pressure O2 Inlet
6	Removable, rechargeable battery (right side)	18	Remote alarm port
7	Active exhalation valve connection port	19	USB port for use by trained personnel only. See <i>“Exporting Multi-View Data to a USB Drive”</i> on page 130 for instructions.
8	Ventec One-Circuit O2 tube connection port (+O configurations only)	20	Cooling air intake and filter
9	Nebulizer drive port (+N configurations only)	21	Power connection port
10	External bacterial filter and Ventec One-Circuit connection port	22	Patient air inlet and filter
11	Handle (side view)	23	Removable, rechargeable battery (left side)
12	Cooling air outlet	24	Suction canister cap to protect suction canister interface port (+S configurations only)
		25	Cooling air outlets

Setup

This chapter includes instructions for placing and setting up VOCSN, including instructions for connecting Ventec One-Circuits, and additional Ventec One-Circuit components. VOCSN was designed for use with Ventec One-Circuits from Ventec Life Systems. Do not use third-party patient circuits with VOCSN.

WARNING: Put VOCSN into service in accordance with the information provided in this Clinical and Technical Manual. VOCSN operation may be impaired or become unsafe by failure to follow setup and operating instructions, the connection of unauthorized accessories, or the unauthorized modification of VOCSN. All modifications made, and accessories used with VOCSN, must meet the requirements of IEC 60601-1. The organization responsible for device setup must ensure the compatibility of VOCSN and all parts and accessories used to provide therapy to the patient prior to use.

WARNING: VOCSN should be set up, configured, and used by trained clinicians and caregivers under the direction of a physician. Patients and caregivers should be instructed not to modify the VOCSN setup or configuration without direction and/or supervision from a clinician.

WARNING: Do not use lubricants on VOCSN or on any part of the Ventec One-Circuit. Lubricating fittings, connections, tubing, or other accessories may result in fire and burns to the patient or caregiver.

WARNING: Use only spare parts recommended by Ventec Life Systems. Using spare parts not recommended by the VOCSN manufacturer may result in fire and burns to the patient or caregiver.

WARNING: Only use carrying cases approved by Ventec Life Systems. Use of unauthorized carrying cases may result in damage to VOCSN, impaired device performance, and risk to the patient.

NOTE: The VOCSN Ethernet and USB ports are intended for use by trained personnel only. The remote alarm port and power connection port can be used with third-party equipment. However, it is the responsibility of the person connecting the third-party equipment to ensure the system complies with clause 16 of IEC 60601-1, 3rd ed., as well as any local laws.

NOTE: When using VOCSN to provide non-invasive ventilation, Ventec Life Systems recommends use of CO₂ monitoring equipment compliant with ISO 80601-2-55. To connect and use CO₂ monitoring with VOCSN, follow all instructions from the equipment manufacturer.

VOCSN Placement

Place VOCSN in a well-ventilated area, ensuring air flows freely around its inlets and vents.

WARNING: Incorrect placement of VOCSN may affect device performance. Do not cover VOCSN, place it in an area in which the vents may become obstructed (such as on its back or on top of compliant bedding), or use it in hazardous environments (such as atmospheres containing pollutants).

NOTE: VOCSN emits heat and gas, including nitrogen, during normal operation. Use VOCSN in a well-ventilated area.

When used in a home environment, VOCSN should be kept away from concentrations of lint, dust, pet dander, and pests. Small particles and/or pests can clog VOCSN filters over time and become lodged inside VOCSN. Clean the air and fan filters regularly to prevent clogging, and move VOCSN to a new location if large volumes of particulate are pulled into the filters. Place VOCSN somewhere it will not be easily accessible by children or pets, such as on a roll stand.

WARNING: Keep VOCSN out of reach of children to avoid the risk of strangulation by cords and tubes, as well as the risk of inhalation or swallowing of small parts. VOCSN includes a hook-and-loop strap to wrap power adapter cabling when not in use.

Over time, direct sunlight may compromise the integrity of VOCSN plastic housing or the Ventec One-Circuit. Place VOCSN in a location that is not exposed to extended periods of direct sunlight.

WARNING: Use of VOCSN outside its recommended range of temperature, altitude, and/or relative humidity may adversely affect the ventilation flow rate and oxygen concentration from VOCSN, and may result in patient harm. See [“Environmental” on page 194](#) for details.

WARNING: Do not use VOCSN in contaminated, hazardous, or explosive environments. Use of VOCSN can be hazardous in these conditions.

WARNING: To protect against EMI (electromagnetic interference) affecting device performance:

- Do not use VOCSN within electromagnetic fields exceeding the limits specified in [Appendix E, “EMC Information”](#). Common sources of electromagnetic fields include security systems, wireless communications equipment, appliances, and medical imaging systems.
- Do not stack VOCSN with other electrical devices during use.
- Do not connect VOCSN to unauthorized cables or accessories. Use of cables or other accessories not approved for use with VOCSN may result in increased electromagnetic emissions or decrease its immunity from other sources of EMI.

WARNING: Accidental button presses could result in inadvertent alteration of the VOCSN configuration or its operation. To reduce the possibility of accidental button presses, do not place in areas that might result in inadvertent touching of the VOCSN touchscreen or its buttons. Use the touchscreen lock feature during cleaning or transport.

Power Setup

VOCSN operates using external power (such as a wall outlet), or VOCSN batteries. Ventec Life Systems recommends connecting VOCSN to a continuous external power source whenever possible. During transport, Ventec Life Systems recommends the use of external power or the removable batteries. Use the internal (non-removable) battery in case of power failure or power transition only.

NOTE: Use only the power supply approved by Ventec Life Systems to connect VOCSN to external sources of power. Ensure the external source of power is rated for use with VOCSN. See *“External Power Requirements” on page 195* for more information.

The VOCSN batteries will begin charging whenever an external power source is applied. All VOCSN features and functions operate normally during battery charging. The charge status indicator light on the front of VOCSN will illuminate orange when the batteries are charging, and illuminate green when the batteries are fully charged. In the status bar, a lightning bolt will appear on the battery indicator of the charging battery.

NOTE: When VOCSN is disconnected from external power and transitions to running on battery power, or switches from running on removable battery to internal battery power, the medium-priority Battery Use alarm will activate.

WARNING: Check the batteries and external power supply regularly to ensure functionality. VOCSN power failure may interrupt ventilation therapy and result in patient harm or death. See *“Power Testing Procedures” on page 138* for instructions.

If the internal battery depletes fully, VOCSN Date and Time settings will reset to their default values. To ensure the Alarm and Event logs record information accurately, verify the VOCSN Date and Time settings before use, and set them to the correct values if necessary.

The Power Supply

The power supply included with VOCSN is part of the ventilation system, and powers the device from AC wall outlets.

Before and during use, periodically inspect the power supply for damage or frays, and to ensure the power supply cords are firmly connected. Do not use damaged power supplies. Replace the power supply if necessary.

The power supply includes a wire retention clip. To ensure the cabling remains seated in the adapter, rotate the retention clip so that it secures the cable to the adapter.

The power supply also comes with a hook-and-loop strap to manage excess cabling. Coil extra cabling between the outlet and VOCSN, and then wrap the strap around the cabling to secure it.

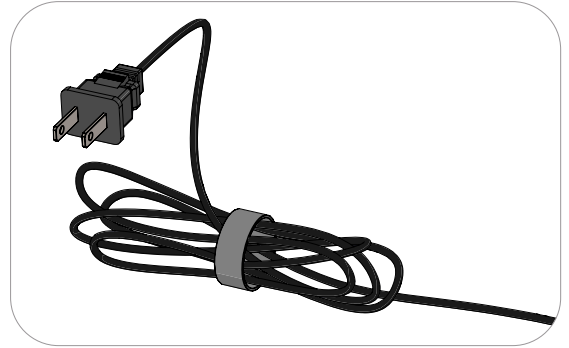
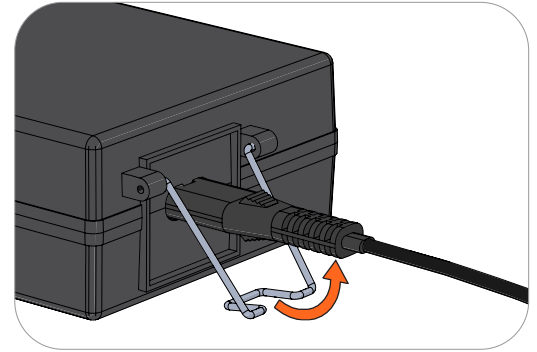

NOTE: Position VOCSN so that it can be easily disconnected from the AC supply mains. To disconnect VOCSN from the AC supply mains, unplug the power supply from the outlet.

NOTE: Do not use portable (e.g., external 115-volt AC) power supplies to power VOCSN, unless the power supply voltage variations are known to be within VOCSN operating limits. See *"External Power Requirements"* on page 195.

To connect VOCSN to a continuous source of external power using the AC Adapter:

- 1** Plug the power supply into the power connection port on the back of VOCSN, and screw the connector clockwise to secure it in place.
- 2** Plug the power supply into a power socket, such as a wall outlet, and verify the external power indicator (🔌) appears on the touchscreen.

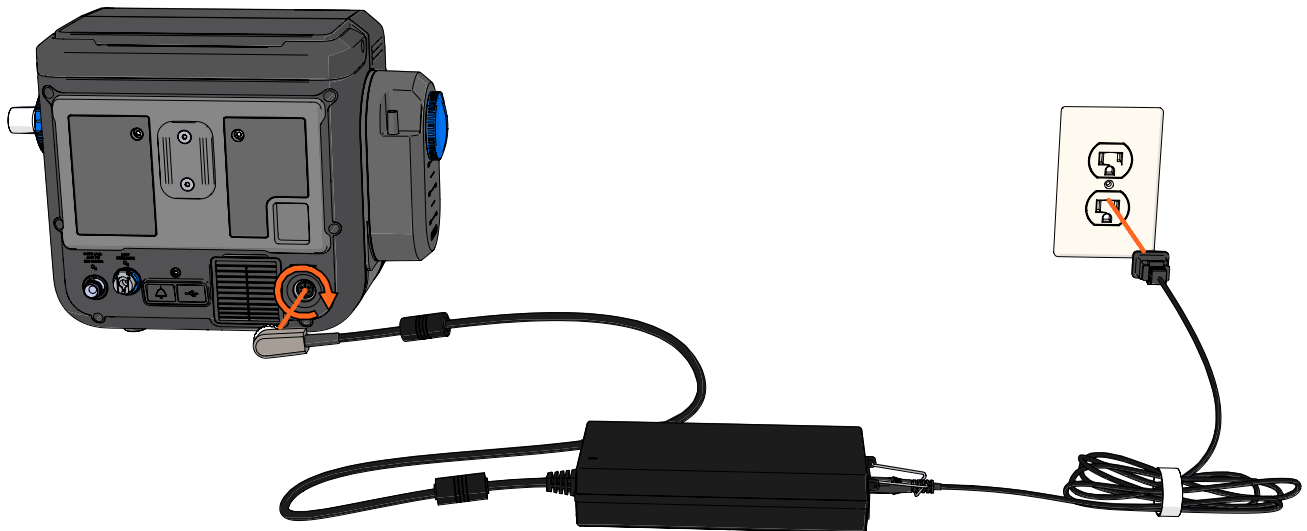

The Optional 24 Volt Wheelchair Power Cable

An optional 24 Volt Wheelchair Power Cable is available from Ventec Life Systems. The 24 Volt Wheelchair Power Cable can be used to connect VOCSN to external sources of DC power, such as wheelchair power outlets.

PRECAUTION: When connected to an external battery (such as a wheelchair battery), VOCSN pulls power from it to run and charge its own batteries. This may affect battery life and/or wheelchair performance (for instance, driving uphill).

When connected to wheelchair power for long periods of time, it may be beneficial to implement a supplemental energy use strategy. For example, traveling with an AC power supply and/or additional, charged VOCSN removable batteries.

The 24 Volt Wheelchair Power Cable comes with a hook-and-loop strap to manage excess cabling. Coil extra cabling between the outlet and VOCSN, and then wrap the strap around the cabling to secure it.



NOTE: Before connecting the 24 Volt Wheelchair Power Cable to a power source, you must verify the voltage and current emitted from the DC power source are within the range of VOCSN operating limits, and that the power source has the correct connection type. See *“External Power Requirements”* on page 195.

The Removable, Rechargeable Batteries

VOCSN includes two removable, rechargeable batteries. These batteries may be removed and reinstalled during VOCSN use.

To remove a battery:

- 1** Lift the blue battery tab.
- 2** Use the tab to pull the battery out of the well gently.

To install a battery:

- 1** Lift the blue battery tab.
- 2** Gently press the battery into the well. Place the base of the battery into the well first, and then press the top of the battery toward VOCSN and into the well.
- 3** Press the battery tab down so that it is flat against the battery.

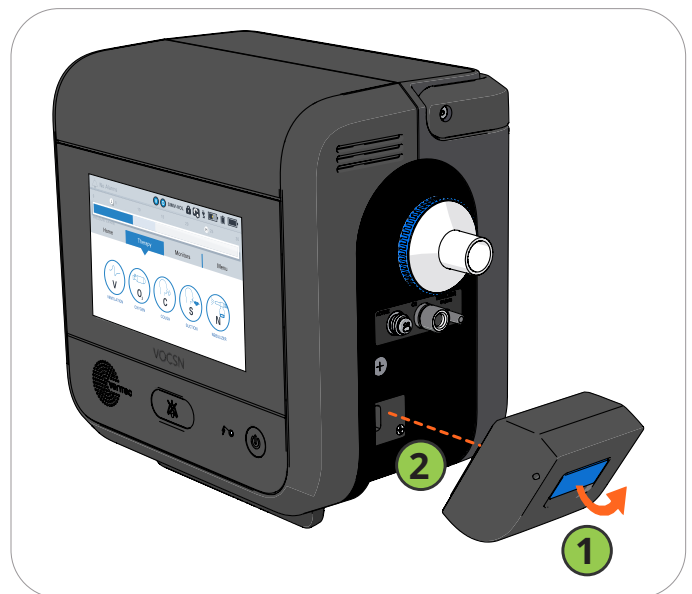

Ventec One-Circuit Setup

VOCSN was designed for use with Active, Passive, Valveless, or Mouthpiece Ventec One-Circuits. Do not use third-party patient circuits with VOCSN. Assemble Ventec One-Circuits and Ventec One-Circuit accessories using the procedures and sequences depicted in this manual.

NOTE: See *"Mouthpiece Patient Circuit Setup"* on page 39 for detailed setup instructions for that circuit type.

Ventec Life Systems offers single-patient use adult and pediatric Ventec One-Circuits for use with VOCSN, which incorporate an optional active or passive exhalation valve, an optional Ventec One-Circuit O₂ tube (to deliver pulse dose Oxygen Direct therapy), and an optional heated wire (for connection to a humidifier). See *"Accessories"* on page 204 for a list of Ventec One-Circuits available from Ventec Life Systems.

Each time the Ventec One-Circuit or its configuration is changed, or the Circuit Type control is modified, run a Pre-Use Test before initiating therapy. The Pre-Use Test will calculate the resistance, and leak of the Ventec One-Circuit to ensure Ventilation therapy is delivered accurately.

WARNING: Adding unauthorized attachments, components, or sub-assemblies to the Ventec One-Circuit can change the pressure gradient of the Ventec One-Circuit and adversely affect the performance of VOCSN.

WARNING: Ventec One-Circuit accessories (including but not limited to filters, nebulizers, and humidifiers) may increase the resistance of the Ventec One-Circuit and affect the accuracy of delivered Ventilation therapy. Inspect all patient circuit filters frequently for signs of increased resistance or blockages, and ensure alarms are set appropriately to verify the accuracy of delivered Ventilation therapy.

WARNING: To reduce the risk of electric shock, do not use anti-static or electrically conductive patient circuits or hoses with the VOCSN system. Only Ventec One-Circuits are approved for use with VOCSN.

WARNING: To ensure patient safety, check the Ventec One-Circuit and verify that all system settings and Presets are appropriate before providing therapy, and on a routine basis during therapy.

WARNING: Any components added to the breathing circuit between the Ventec One-Circuit exhalation valve and the patient will increase the amount of gas that the patient rebreathes with each breath. The addition of components into the breathing circuit should be considered carefully, especially for small pediatrics.

NOTE: When providing non-invasive ventilation, use CO₂ monitoring equipment compliant with ISO 80601-2-55 to ensure patient safety.

Ventec One-Circuits may be connected to a humidifier and/or other patient circuit components as needed. See *"Connecting Ventec One-Circuit Components"* on page 35 for detailed instructions.

Using a Trach, ET Tube, or Non-Vented Mask

VOCSN may be connected to a non-vented mask, trach or ET tube to provide Ventilation therapy using an Active or Passive Ventec One-Circuit. These circuit types include an exhalation valve designed to expel exhaled gases. See the following pages for detailed setup instructions.

NOTE: Masks with an anti-asphyxia valve should not be used with an Active Ventec One-Circuit, because bias flow may not be sufficient to close the valve when needed. Active circuit valves open automatically when there is no pressure in the circuit, serving the same purpose as anti-asphyxia valves.

Using a Vented Mask

VOCSN may be connected to a vented mask to provide Ventilation therapy using a Valveless Ventec One-Circuit. Valveless circuits do not include an exhalation valve, and are designed for use with a mask patient interface incorporating a fixed leak. See the following pages for detailed setup instructions.

NOTE: Vented masks used with VOCSN must be connected with a Valveless or Passive Ventec One-Circuit and have an integrated leak of 20 to 50 L/min at 10 cmH₂O to ensure proper device performance.

WARNING: Masks are not recommended for use with patients <7 kg, due to the unavailability of masks sized to provide a seal tight enough to deliver effective Ventilation therapy.

Using a High Flow Nasal Cannula

VOCSN may be connected to a high flow nasal cannula to provide High Flow therapy using a Valveless Ventec One-Circuit.

NOTE: When using a Valveless Ventec One-Circuit, leave the circuit connected to VOCSN, and disconnect the mask or high flow nasal cannula while running the Pre-Use Test.

Connecting an Active, Passive, or Valveless Ventec One-Circuit

The Ventec One-Circuit comes with an optional active or passive exhalation valve, an optional Ventec One-Circuit O₂ tube (to deliver pulse dose Oxygen Direct therapy), and an optional heated wire (for connection to a humidifier). The setup procedure will depend on the type of Ventec One-Circuit and the accessories used. To connect a Ventec One-Circuit to VOCSN:

- 1** Connect a bacterial filter. See *"Connecting an External Bacterial Filter"* on page 28.
- 2** Connecting the Ventec One-Circuit depends on whether you are using an HME or a humidifier, and whether or not you are connecting the Ventec Humidifier Bypass (for Touch Button Cough therapy). Follow the instruction below that corresponds to the Ventec One-Circuit configuration:
 - To configure the Ventec One-Circuit with an HME instead of a humidifier, see *"Connecting a Ventec One-Circuit Without a Humidifier"* on page 28.
 - To configure the Ventec One-Circuit with a humidifier, without connecting a Ventec Humidifier Bypass, see *"Connecting a Ventec One-Circuit to a Humidifier (Without the Ventec Humidifier Bypass)"* on page 30.
 - To configure the Ventec One-Circuit with a humidifier and the Ventec Humidifier Bypass (for Touch Button Cough therapy), see *"Connecting a Ventec One-Circuit, Humidifier, and Ventec Humidifier Bypass"* on page 31.
- 3** If the Ventec One-Circuit includes an integrated O₂ tube, connect it to VOCSN. See *"Connecting a Ventec One-Circuit O₂ Tube"* on page 32 for instructions.
- 4** If you are using an active Ventec One-Circuit, connect the flow sensor (multilumen) tubing to VOCSN. See *"Connecting an Active Ventec One-Circuit"* on page 33.
- 5** To attach other components to the Ventec One-Circuit, such as a nebulizer or closed suction catheter, see *"Connecting Ventec One-Circuit Components"* on page 35.
- 6** The diagram on the next page illustrates the Ventec One-Circuit and optional components in the correct configuration. Consult *"Ventec One-Circuit Component Connection Order"* on page 27 to verify that everything is connected in the correct order.

Ventec One-Circuit Component Connection Order

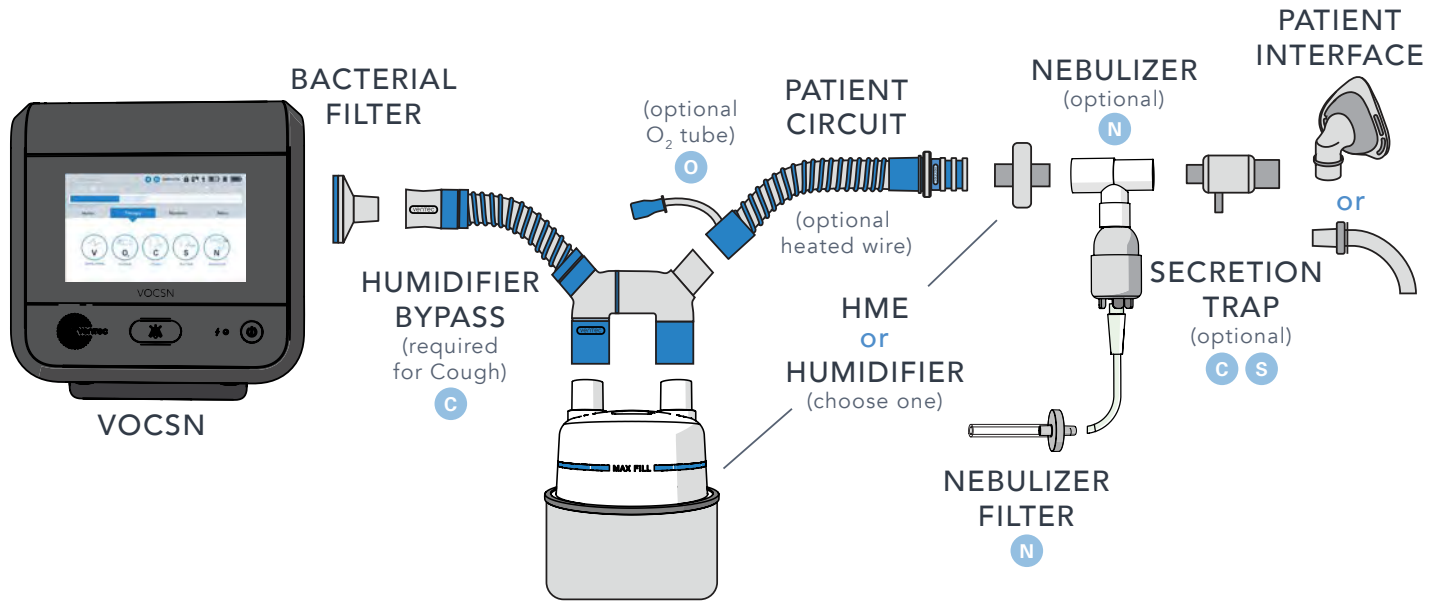

Item Name	Required?	Additional Information
VOCSN Bacterial Filter	Required	See <i>"Connecting an External Bacterial Filter"</i> on page 28 for instructions.
Ventec Humidifier Bypass	Required for using Touch Button Cough therapy with a connected humidifier	The Ventec Humidifier Bypass prevents water damage to VOCSN during Cough therapy.
Humidifier	Optional	Include a form of humidification (either an HME or humidifier).
Ventec One-Circuit	Required	Use either an Active, Passive, or Valveless Ventec One-Circuit. Ventec One-Circuits may include an integrated O2 tube and/or a heated wire. Active Ventec One-Circuits include flow sensor tubing. (For Mouthpiece Patient Circuit instructions, see <i>"Mouthpiece Patient Circuit Setup"</i> on page 39.)
Heat-Moisture Exchanger (HME)	Optional	Include a form of humidification (either an HME or humidifier). See <i>"Connecting an HME (Heat-Moisture Exchanger)"</i> on page 35 for instructions.
Nebulizer	Optional	Connect a nebulizer to the nebulizer drive port. See <i>"Connecting a Nebulizer Cup to the Patient Circuit"</i> on page 36 for instructions.
Patient interface	Required	Examples of a patient interface include a mask, trach, or ET tube. Active and Passive Ventec One-Circuits include an exhalation valve and are intended for use with non-vented masks, trach, or ET tubes. Valveless Ventec One-Circuits are intended for use with vented masks, or nasal cannulas for High Flow therapy.

Connecting an External Bacterial Filter

Connect an external bacterial filter to reduce the risk of cross-contamination. Attach a bacterial filter to the Ventec One-Circuit connection port before connecting a Ventec One-Circuit.

Fit the bacterial filter against VOCSN, aligning the icons on the filter and VOCSN, then twist the filter to lock it into place.

VOCSN contains a secondary, internal bacterial filter to help protect against cross-contamination in case of external bacterial filter failure. The internal bacterial filter should be replaced whenever it may have become cross-contaminated, such as when the external bacterial filter becomes compromised, or if an infectious disease specialist recommends its replacement. See *“Replacing the Internal Bacterial Filter”* on page 167 for instructions.

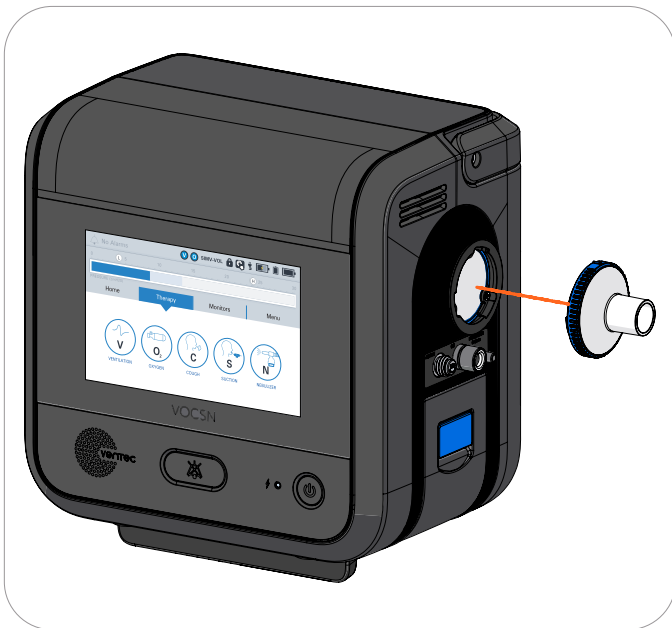

Connecting a Ventec One-Circuit Without a Humidifier

When not using a humidifier as part of the Ventec One-Circuit configuration, connect the circuit to the bacterial filter. Connect an HME to the Ventec One-Circuit to provide the patient with humidification, following the instructions in *“Connecting an HME (Heat-Moisture Exchanger)”* on page 35.

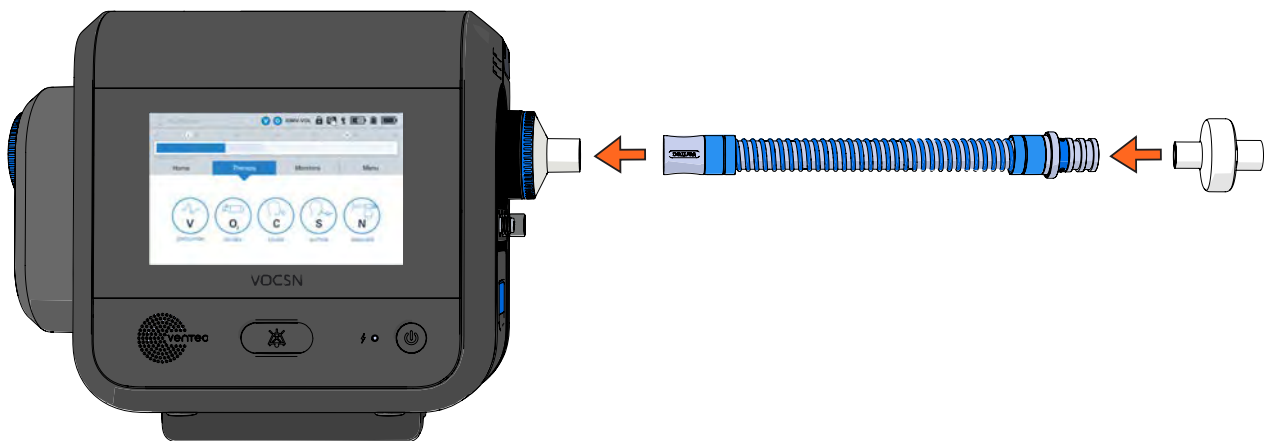

Connecting a Humidifier and Heated Wire Ventec One-Circuit

When using a humidifier, use a heated-wire Ventec One-Circuit to manage water condensation inside the Ventec One-Circuit. Place the humidifier below VOCSN and the patient to prevent water from leaking into the patient.

WARNING: Do not use heated wire Ventec One-Circuits on, within, or under localized heat sources or insulating materials such as blankets or thermal chambers. External sources of heat or insulation may impair the performance of heated wire Ventec One-Circuits.

CAUTION: Before delivering Cough therapy when using a heated humidifier, verify a Ventec Humidifier Bypass is installed, or disconnect the humidifier from the Ventec One-Circuit. Cough therapy may cause water damage to VOCSN when a humidifier is attached to the Ventec One-Circuit without an installed Ventec Humidifier Bypass. See *"Connecting a Ventec One-Circuit, Humidifier, and Ventec Humidifier Bypass"* on page 31 for installation instructions and more information. The Ventec Humidifier Bypass was designed to remain connected to the Ventec One-Circuit during Ventilation therapy, allowing the delivery of Integrated Cough Assistive Therapy (ICAT) while using a humidifier, without reconfiguring the Ventec One-Circuit.

NOTE: Using humidifiers or other accessories not specified for use with this system may impair VOCSN performance. Ventec Life Systems recommends use of the Fisher & Paykel HC550, the Fisher & Paykel MR850, or equivalent. Humidifiers connected to the VOCSN Ventec One-Circuit should comply with ISO 8185.

Depending on whether you will use Integrated Cough Assistive Therapy (ICAT) with a connected humidifier, follow the setup instructions as described in *"Connecting a Ventec One-Circuit to a Humidifier (Without the Ventec Humidifier Bypass)"* on page 30 or *"Connecting a Ventec One-Circuit, Humidifier, and Ventec Humidifier Bypass"* on page 31 to connect a humidifier, humidifier bypass (if necessary), and heated wire Ventec One-Circuit to VOCSN.

Connecting a Ventec One-Circuit to a Humidifier (Without the Ventec Humidifier Bypass)

If not using Integrated Cough Assistive Therapy (ICAT) with a connected humidifier, install the Ventec One-Circuit directly to the humidifier.

To connect a humidifier to the Ventec One-Circuit (without the Ventec Humidifier Bypass):

- 1** Connect a length of patient circuit tubing (sold separately) to the open end of the external bacterial filter. Connect the other end to the humidifier.
- 2** Connect a heated wire Ventec One-Circuit to the humidifier. Follow instructions from the humidifier manufacturer to connect heated wire and temperature sensor lines from the humidifier to the Ventec One-Circuit.

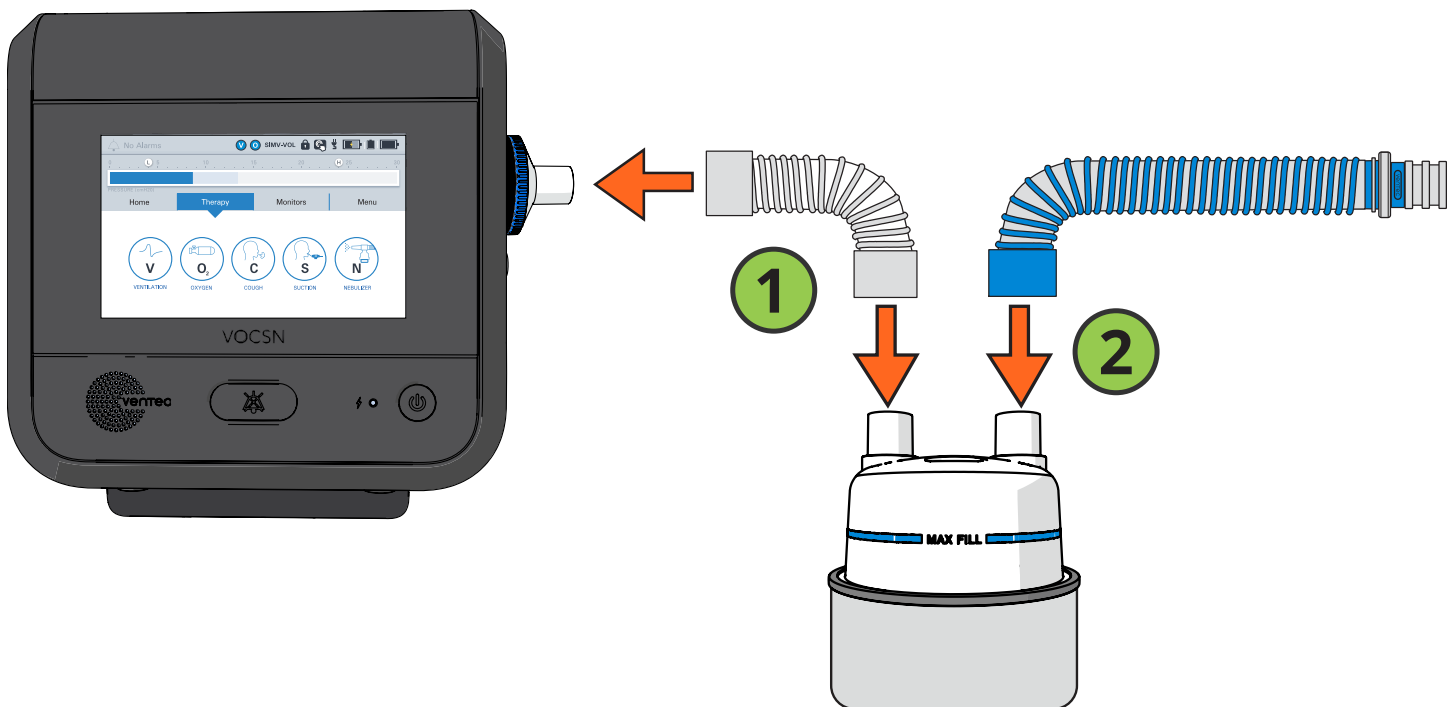

Connecting a Ventec One-Circuit, Humidifier, and Ventec Humidifier Bypass

The Ventec Humidifier Bypass is designed to remain connected to the Ventec One-Circuit. When using a humidifier, this allows Integrated Cough Assistive Therapy (ICAT) delivery without reconfiguring the Ventec One-Circuit.

To connect a humidifier and Ventec Humidifier Bypass to a heated wire Ventec One-Circuit, follow setup instructions provided by the humidifier manufacturer, and:

- 1** Connect the flexible Ventec Humidifier Bypass tubing to the external bacterial filter.
- 2** Connect the Ventec Humidifier Bypass to the humidifier.
- 3** Connect the heated wire Ventec One-Circuit to the Ventec Humidifier Bypass.
- 4** Follow instructions from the humidifier manufacturer to connect heated wire and temperature sensor lines from the humidifier to the Ventec One-Circuit.

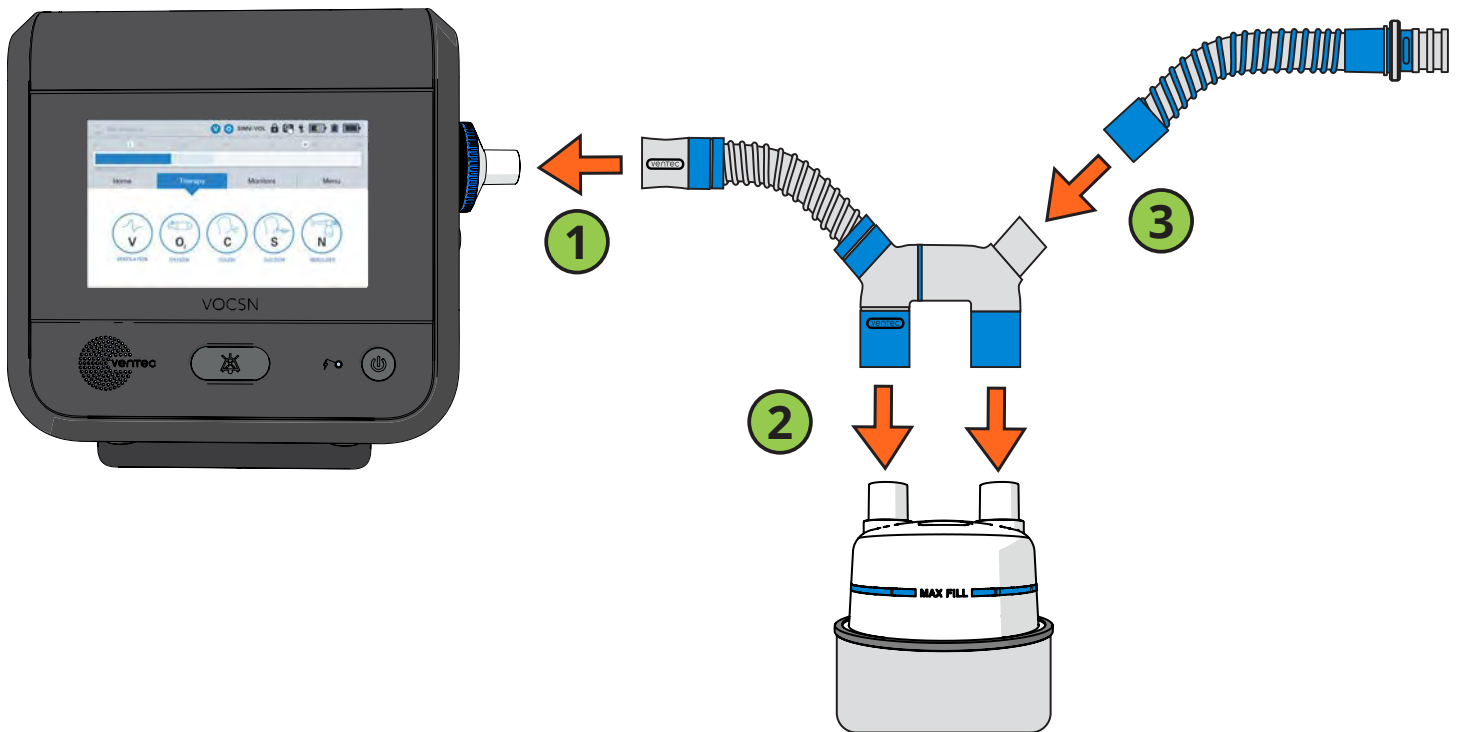

Connecting a Ventec One-Circuit O2 Tube

If your Ventec One-Circuit has an integrated O2 tube, connect the O2 tube to the oxygen output port on the right side of VOCSN. Fit the connection adapter around the port securely.

NOTE: To ensure proper Oxygen therapy performance, make sure the O2 tube is fully connected. The end of the blue connector should be flush against VOCSN.

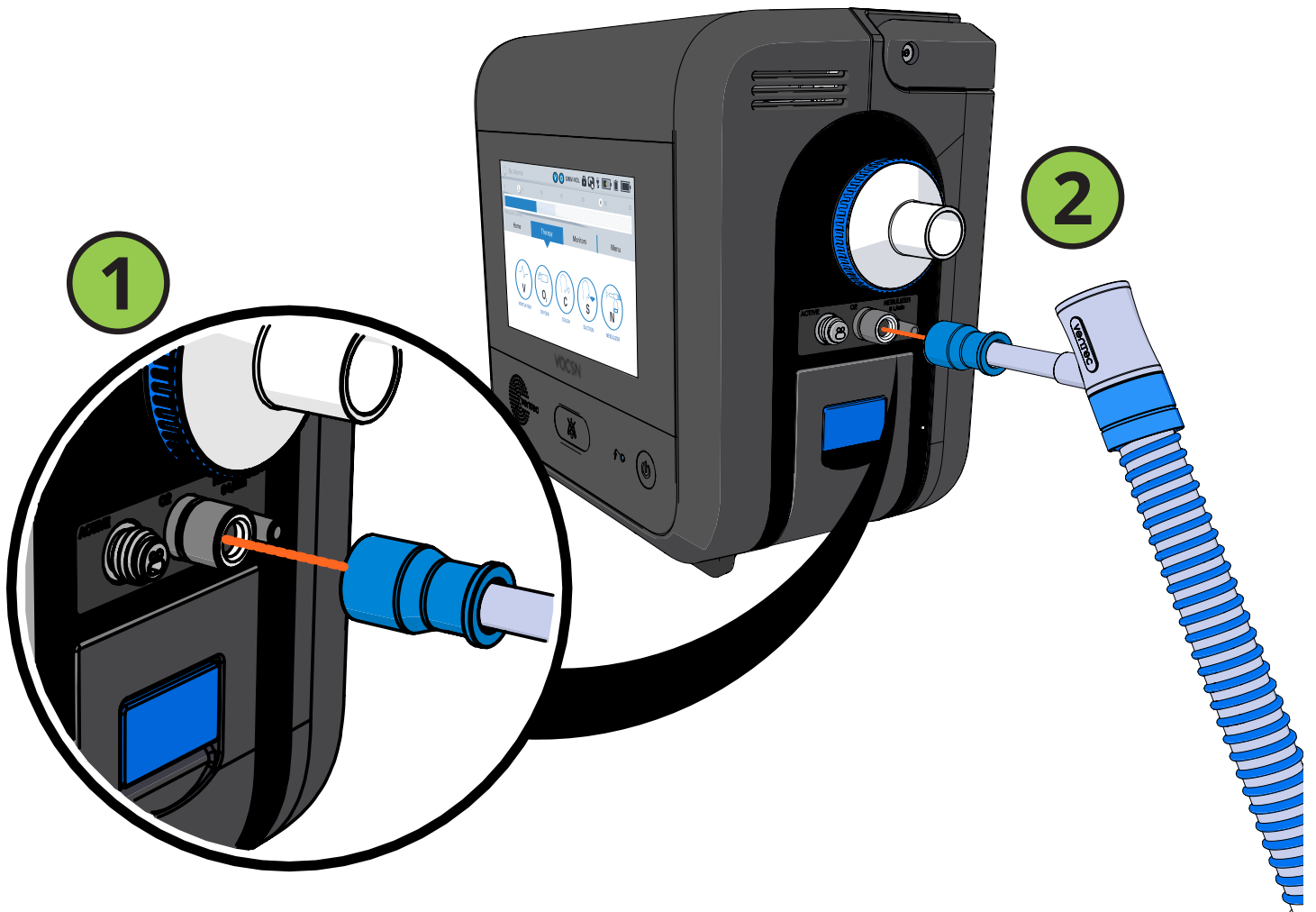

Connecting an Active Ventec One-Circuit

If you are using an active Ventec One-Circuit, the flow sense and drive lines at the exhalation valve (the multilumen tube) must be connected to VOCSN before use.

- 1** Fit the oval connector tube into place in the Active connection port.
- 2** Then, fit the connecting screw cap over the port and twist it clockwise until it is firmly secured.

CAUTION: Ensure that no part of the active exhalation valve flow sensor tubing becomes pinched during setup or use. Pinched tubing can affect VOCSN performance, including its ability to provide accurate breath triggering, cycling, and monitoring.

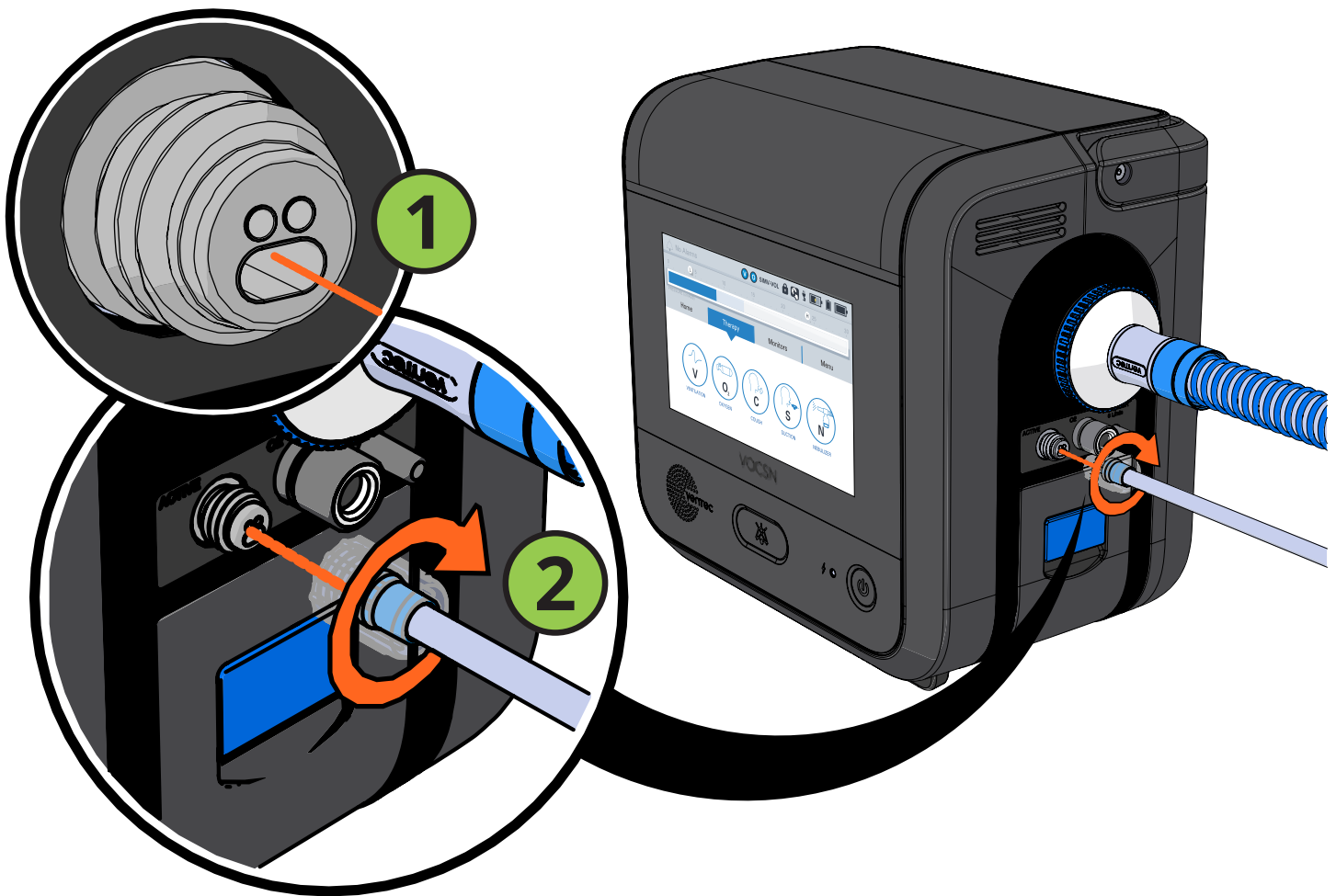

Connecting an Exhalation Bacterial Filter

Some patient circuit configurations include an Exhalation Filter Cuff around the exhalation valve so that a bacterial filter can be connected to prevent cross-contamination from exhaled gasses.

If your patient circuit configuration includes a Exhalation Filter Cuff, connect a bacterial filter by following these instructions:

- 1 Rotate the Exhalation Filter Cuff if needed so that it is pointing down.

While in use, ensure the bacterial filter port in the Exhalation Filter Cuff is oriented down to prevent it from collecting water. Water collection in the exhalation valve may affect VOCSN performance and/or cause harm to the patient.

- 2 Inspect the cuff around the exhalation valve to ensure it's properly sealed.
- 3 Connect a bacterial filter by fitting it snugly into the port in the exhalation valve cuff.

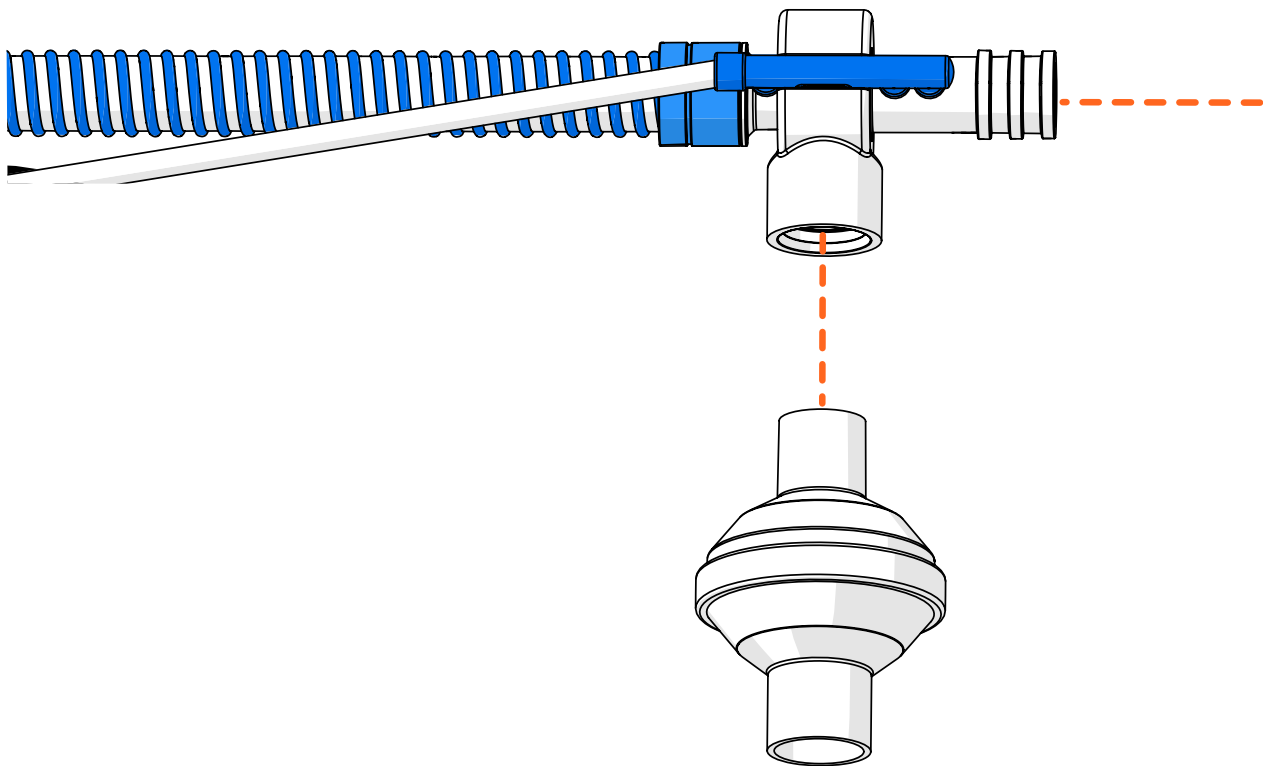

Connecting Ventec One-Circuit Components

If necessary, attach additional Ventec One-Circuit components, such as an HME, nebulizer, or closed-suction catheter to the Ventec One-Circuit. For setup instructions, see:

- “Connecting an HME (Heat-Moisture Exchanger)” on page 35
- “Connecting a Nebulizer Cup to the Patient Circuit” on page 36
- “Connecting a Closed-Suction Catheter to the Patient Circuit” on page 38

NOTE: Ventec Life Systems recommends including a humidifier or heat-moisture exchanger (HME) as part of active, passive, and valveless Ventec One-Circuit configurations.

Connecting an HME (Heat-Moisture Exchanger)

If you’re not using a humidifier, connect an HME to the Ventec One-Circuit between the exhalation valve and the patient. For the most accurate Vte monitoring with an Active Ventec One-Circuit, connect a flex tube between the exhalation valve and the HME.

Follow all setup instructions provided by the HME manufacturer.

NOTE: Any HME attached to the VOCSN Ventec One-Circuit should comply with ISO 9360-1 or ISO 9360-2.

NOTE: When used with a vented mask, exhaled, humidified air exits the mask instead of traveling through the HME, greatly reducing its efficacy.

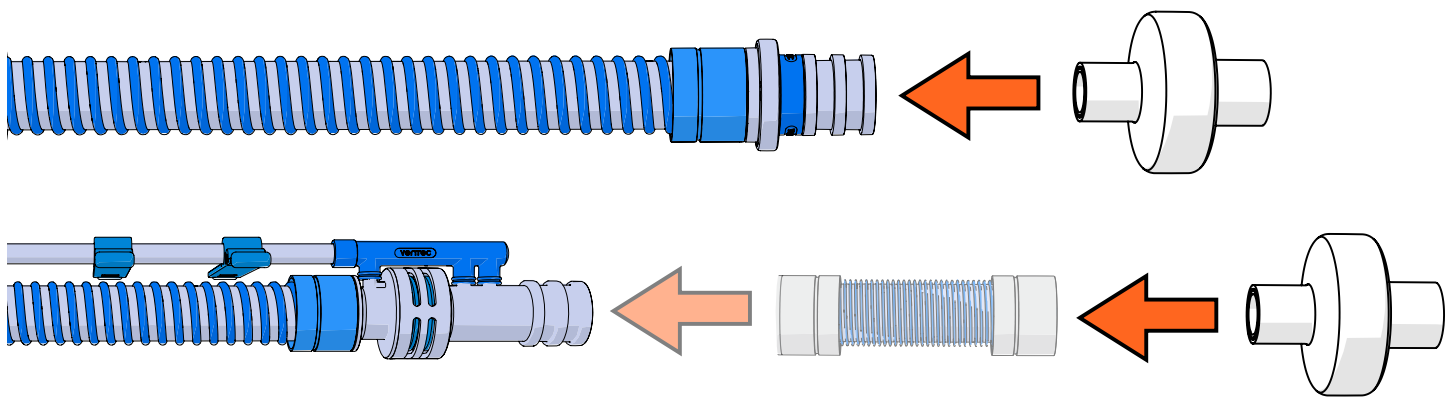

Connecting a Nebulizer Cup to the Patient Circuit

The VOCSN nebulizer drive is intended for use with third-party, 6 L/min nebulizer cups, as part of the VOCSN breathing system. To use the VOCSN nebulizer drive, connect a nebulizer cup to the Ventec One-Circuit and to the nebulizer port on the side of VOCSN. The nebulizer should be disconnected between uses.

VOCSN may also be configured to compensate for the flow added to the patient circuit from an external 6 L/min nebulizer. Follow all instructions from the manufacturer to connect an external nebulizer cup to the patient circuit, and see *“Starting Nebulizer therapy” on page 158* for instructions on compensating Ventilation therapy for the flow from an external 6 L/min nebulizer.

NOTE: To ensure proper device operation, all nebulizer parts connected to VOCSN should comply with the relevant requirements of ISO 27427.

Follow all setup and operating instructions provided by the nebulizer manufacturer, including any indications for use or contraindications regarding fluid types for use with the nebulizer.

WARNING: Use only 6 L/min nebulizer cups with VOCSN. VOCSN ventilation compensates for 5.9 L/min of nebulizer flow while the nebulizer drive is active. When gas is added to the Ventec One-Circuit from a nebulizer producing a flow less or more than 6 L/min, the accuracy of delivered ventilation may be temporarily affected.

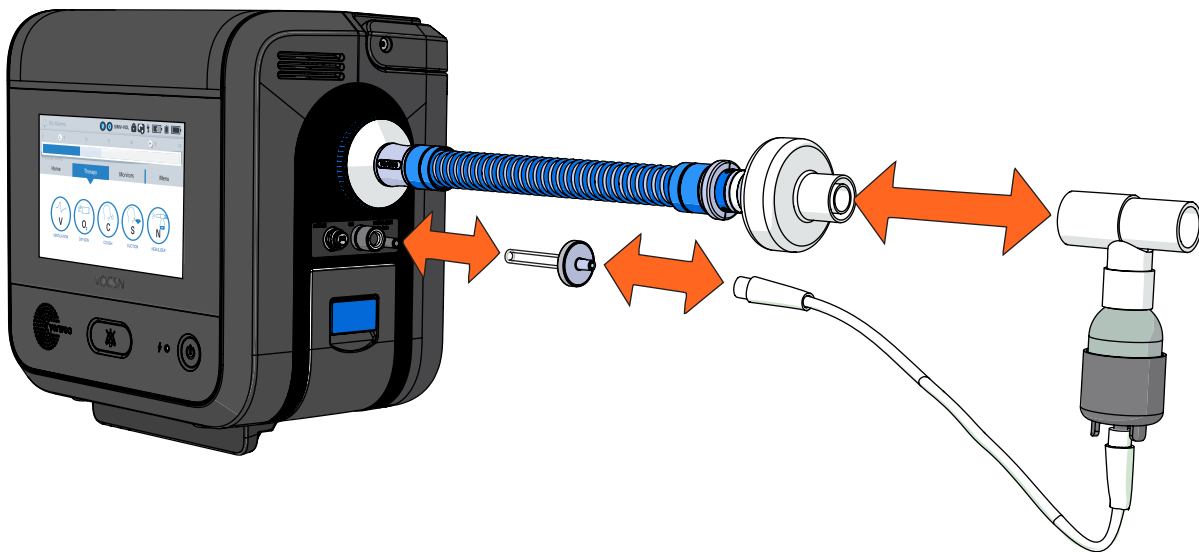

To connect a nebulizer cup to VOCSN:

- 1 Connect a VOCSN Nebulizer Filter to the nebulizer port.
- 2 Connect one end of the nebulizer tubing to the VOCSN Nebulizer Filter, and the other end to the bottom of the nebulizer cup.

- 3** Add medication to the nebulizer cup by following all instructions from the nebulizer cup manufacturer.
- 4** Configure nebulizer therapy by pressing the **Therapy** tab, and then the Nebulizer button. If needed, set the Nebulizer duration control by using the plus (+) and minus (-) buttons. The Nebulizer Duration should be set to provide ample time for all medication in the cup to be delivered to the patient. See *"Starting Nebulizer therapy" on page 158* for more information.
- 5** Before connecting the nebulizer cup to the patient circuit, press **START** to begin therapy, and confirm an aerosol mist is created from the nebulizer cup.

NOTE: During the brief period while Nebulizer therapy is running without the nebulizer connected to the patient circuit, delivered Tidal Volumes may be affected.

- 6** Attach the nebulizer cup and tee between the exhalation valve and the patient interface (or, if the tee is already in place, attach the nebulizer cup to it). Verify the nebulizer cup is vertical to ensure that all medication in the cup is properly nebulized.

NOTE: If an HME is used, connect the nebulizer cup between the HME and the patient to prevent the HME from trapping nebulized medication.

NOTE: If a passive Ventec One-Circuit is used, Ventec Life Systems recommends connecting a filter between the distal end of the circuit and the nebulizer tee to ensure nebulized material does not collect in the passive valve and obstruct airflow.

- 7** When nebulizer therapy is complete, disconnect the nebulizer from the VOCSN nebulizer port, and then from the patient circuit. Clean the nebulizer cup following all instructions from the nebulizer manufacturer.

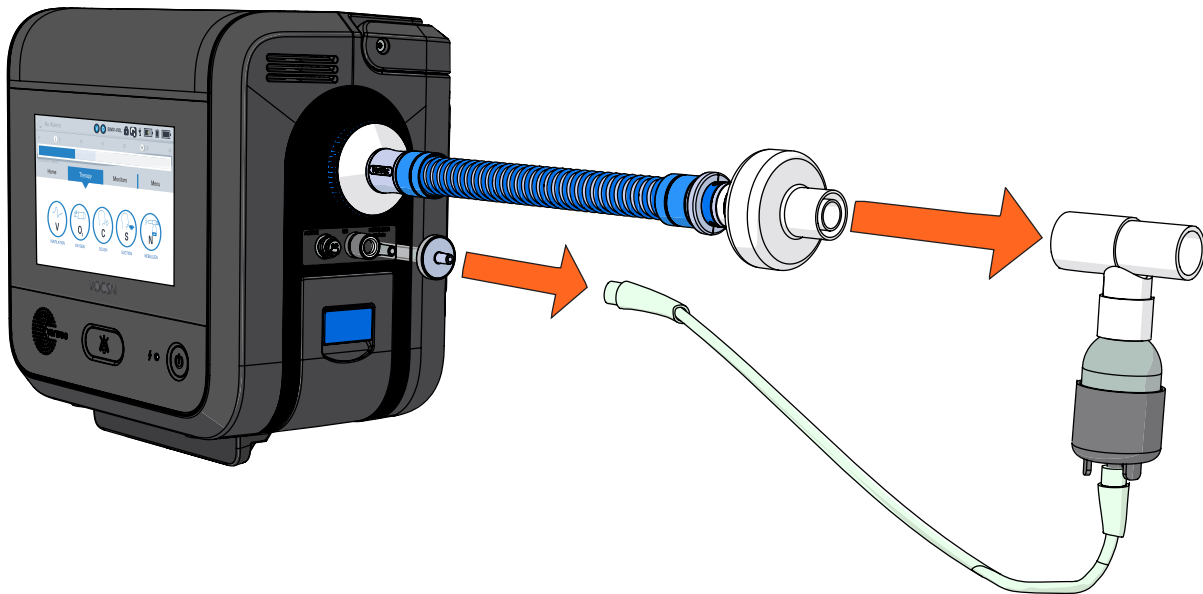

Connecting a Closed-Suction Catheter to the Patient Circuit

To keep secretions from clogging an HME or other Ventec One-Circuit accessories, connect a closed-suction catheter as close to the patient interface as possible. Follow all instructions from the catheter manufacturer.

NOTE: If used, suction catheters should comply with ISO 8836 to ensure proper VOCSN performance.

NOTE: To connect an open-suction catheter, see *"Connecting the External Suction Canister Adapter"* on page 47

To connect a closed-suction catheter:

- 1 Connect the closed-suction catheter to the Ventec One-Circuit exhalation valve, HME (if used), or nebulizer (if used).
- 2 Connect suction tubing to the closed-suction catheter and a connected suction canister. See *"Suction Setup"* on page 44 for instructions.

Setting up Ventilation therapy with a Speaking Valve

VOCSN may be used with an active Ventec One-Circuit and/or a pressure ventilation mode and a connected speaking valve. Because gas delivered from VOCSN exits the mouth rather than the Ventec One-Circuit, volume delivery may be affected when a passive Ventec One-Circuit is used. Therefore, volume ventilation modes with a passive Ventec One-Circuit and connected speaking valve is not recommended.

Gas exiting the mouth through a speaking valve rather than through the Ventec One-Circuit exhalation valve will cause the monitored Vte and Minute Volume to appear smaller than expected. In addition, the Leak monitor will likely appear larger than expected as the patient speaks. This may cause the activation of the Low Minute Volume or Patient Circuit Disconnect alarm.

WARNING: If the Low Minute Volume and/or Patient Circuit Disconnect alarm cannot be set appropriately for the patient condition because of a connected speaking valve or other reason, use an alternate respiratory monitor such as an oximeter or cardio-respiratory monitor to detect hypoventilation.

Mouthpiece Patient Circuit Setup

Mouthpiece patient circuits are recommended for use with patients who can place their mouths on the circuit to initiate breaths on their own.

WARNING: Using a mouthpiece for Ventilation or Cough therapy is not recommended for patients <5 years of age, due to the requirements for physiological and neurological development, as well as neuromuscular coordination necessary for the application of effective therapy.

Setting the Circuit Type control to Mouthpiece will limit the available ventilation modes and controls to those that are suitable for use with this type of patient circuit. See *"Setting VOCSN Controls for Mouthpiece Ventilation"* on page 88 for additional information.

To connect a mouthpiece patient circuit to VOCSN, begin by connecting an external bacterial filter. Connect the Mouthpiece Circuit Kit components in the order depicted below.

- 1** Reducer cuff
- 2** 15mm circuit tubing (one piece)
- 3** Optional Mouthpiece Circuit Support Arm, available separately
- 4** Coupler
- 5** Flexible extension (optional)
- 6** Angled mouthpiece



Oxygen Therapy Setup

Oxygen therapy can be delivered to the patient from three sources:

- Using the internal O2 Concentrator (Pulse Dose mode only)
- Using an external source of high-pressure oxygen (Pulse Dose or FiO2 mode)
- Using an external low-pressure oxygen source, which can be used alone or in as an additive in combination with another source.

NOTE: The oxygen source options available on VOCSN will depend on its configuration.

Oxygen therapy can be delivered to the patient in three modes:

- Using FiO2 mode to deliver a continuous stream of oxygen into the Ventec One-Circuit from an external source of high-pressure oxygen.
- Using the Oxygen Direct system to deliver oxygen in Pulse Dose mode through the Ventec One-Circuit O2 tube. The Oxygen Direct system can be used with oxygen from the internal O2 Concentrator, or from an external source of high-pressure oxygen connected to the VOCSN high-pressure oxygen port.
- Using a connected external source of low-pressure oxygen to flow oxygen through VOCSN and into the Ventec One-Circuit. Low-pressure oxygen is additive and can be used in addition to oxygen from the internal O2 Concentrator or an external high-pressure oxygen source.

The following chart displays oxygen therapy delivery modes and associated ranges:

O2 Mode	Source of Delivery	Range	Monitor
FiO2	High-pressure	21% to 100%	FiO2
O2-Bleed in*	Low-pressure	1 to 20 lpm	FiO2 (during High Flow)
Pulse Dose	High-pressure	0.5 to 6 lpm	Calculated FiO2
Pulse Dose	Internal Concentrator	0.5 to 6 lpm	Calculated FiO2

*Low-pressure O2-Bleed in can be added while using High Pressure or Internal Concentrator

NOTE: Do not bypass the oxygen ports in the back of VOCSN to bleed oxygen directly into the Ventec One-Circuit from an external oxygen source. Any source of external oxygen used with VOCSN should be connected to the appropriate port on the back of the device. Bleeding oxygen into the Ventec One-Circuit can adversely affect the efficacy of delivered therapy.

WARNING: If the patient's prescribing healthcare professional determines Oxygen therapy is critical to patient care, provide continuous monitoring, such as pulse oximetry or proximal FiO2 monitoring.

Setting Up the Internal O2 Concentrator

The internal O2 Concentrator is an optional VOCSN feature. The internal O2 Concentrator will provide Oxygen Direct therapy in Pulse Dose mode through a Ventec One-Circuit O2 tube. To set up the internal O2 Concentrator:

- 1 If needed, enable the internal O2 Concentrator. See *"Enabling and Disabling Prescribed Therapies"* on page 89.
- 2 Connect a Ventec One-Circuit O2 tube to the O2 output port on the right side of VOCSN. See *"Connecting a Ventec One-Circuit O2 Tube"* on page 32 for instructions.
- 3 Verify VOCSN is not near open flame, ignited cigarettes, or flammable gases.
- 4 Configure Pulse Dose mode and set the O2 Flow Equivalent control to provide the prescribed therapy to the patient. See *"Changing Oxygen Settings"* on page 91 for configuration instructions.

WARNING: The internal O2 Concentrator is not intended for life support. Where the prescribing healthcare professional has determined that an interruption in the supply of oxygen, for any reason, may have serious consequences to the user, an alternate source of oxygen should be available for immediate use.

CAUTION: Using unauthorized accessories not specified for use with the internal O2 Concentrator may adversely affect the effective delivery of Oxygen Direct therapy.

NOTE: Hot, humid environments may reduce the oxygen generation capacity of the internal O2 Concentrator.

Setting Up External Oxygen Sources

All VOCSN can be used with an external source of low-pressure. Depending on the features enabled, VOCSN can be used with an external source of high-pressure oxygen. To ensure safe use of external oxygen sources, first verify the following:

- VOCSN is not near open flame, ignited cigarettes, or flammable gases.
- VOCSN is not connected to an unregulated oxygen source.
- External oxygen sources are connected to the proper port on the back of VOCSN, not directly to the Ventec One-Circuit, and if possible, are turned off when not in use.
- If the FiO2 control is used, that the FiO2 monitor is enabled, and the High and Low FiO2 alarms are set appropriately for the patient condition.
- The oxygen source meets the pressure or flow specification requirements described in *"Inputs and Outputs"* on page 194.

Connecting External High-Pressure Oxygen

External high-pressure oxygen sources can be connected to VOCSN to provide Oxygen therapy in either Pulse Dose or FiO2 mode.

NOTE: Whenever the FiO2 control is set above 21%, use the FiO2 monitor and set the High FiO2 and Low FiO2 alarms appropriately for the patient condition.

To connect an external source of high-pressure oxygen:

- 1 Connect the oxygen hose from the oxygen source to the high-pressure O2 port on the back of VOCSN. Twist the connector on the oxygen tubing clockwise until it is tight.
 - 2 Configure VOCSN to provide Oxygen therapy using either Pulse Dose or FiO2 mode. See *"Changing Oxygen Settings"* on page 91.
- If using Pulse Dose mode, verify that the integrated Ventec One-Circuit O2 tube is connected to the O2 output port on the right side of VOCSN. See *"Connecting a Ventec One-Circuit O2 Tube"* on page 32 for instructions.

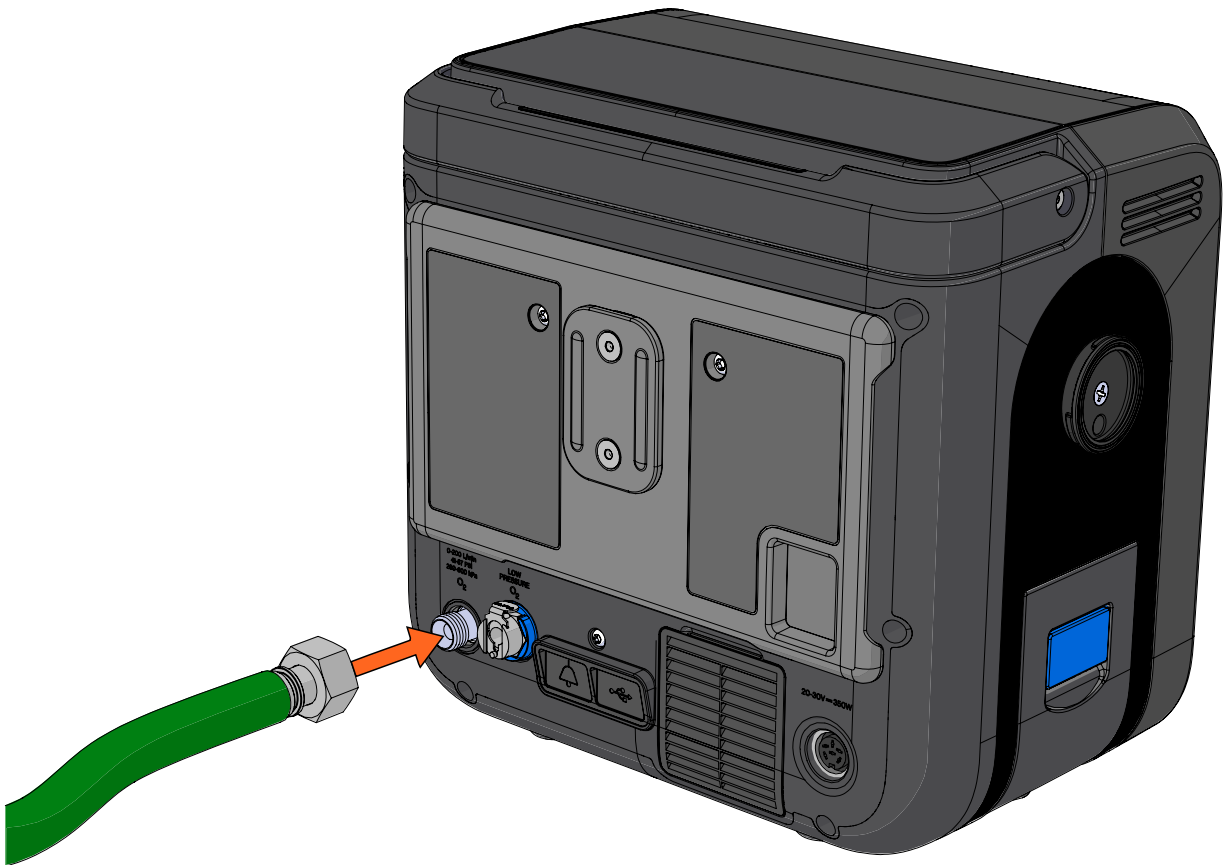

Connecting External Low-Pressure Oxygen

External low-pressure oxygen sources can be connected to VOCSN to add oxygen into the Ventec One-Circuit. The flow of low-pressure oxygen is controlled by the oxygen source, not by the VOCSN oxygen controls. Oxygen from a low-pressure oxygen source is additive, and can be used in conjunction with oxygen from the internal O₂ concentrator or an external high-pressure source.

NOTE: The FiO₂ Monitor and FiO₂ alarms are not available while using an external source of low-pressure oxygen.¹ When an external low-pressure oxygen source is applied, use external O₂ monitoring equipment (which may be included with the oxygen source) compliant with ISO 80601-2-55 to verify oxygen delivery before putting the system into service. To connect external O₂ monitoring equipment to VOCSN, follow all instructions provided by the monitoring equipment manufacturer.

NOTE: To prevent oxygen accumulation in and around the device, ensure the low-pressure oxygen source is off while VOCSN is off.

To connect an external low-pressure oxygen source (e.g., oxygen concentrator or liquid oxygen):

- 1** Connect an O₂ Low Pressure Inlet Adapter (available from Ventec Life Systems) to the low-pressure O₂ port on the back of VOCSN.
- 2** Connect the oxygen source to the adapter.
- 3** Follow all instructions from the low-pressure oxygen source manufacturer to begin providing Oxygen therapy. See *"Low-Pressure Oxygen Blending"* on page 225 for charts illustrating the expected FiO₂ at various settings.

NOTE: Remove the O₂ Low-Pressure Inlet Adapter when it is not in use. If external high-pressure oxygen is used while the adapter is connected, oxygen may leak from it.

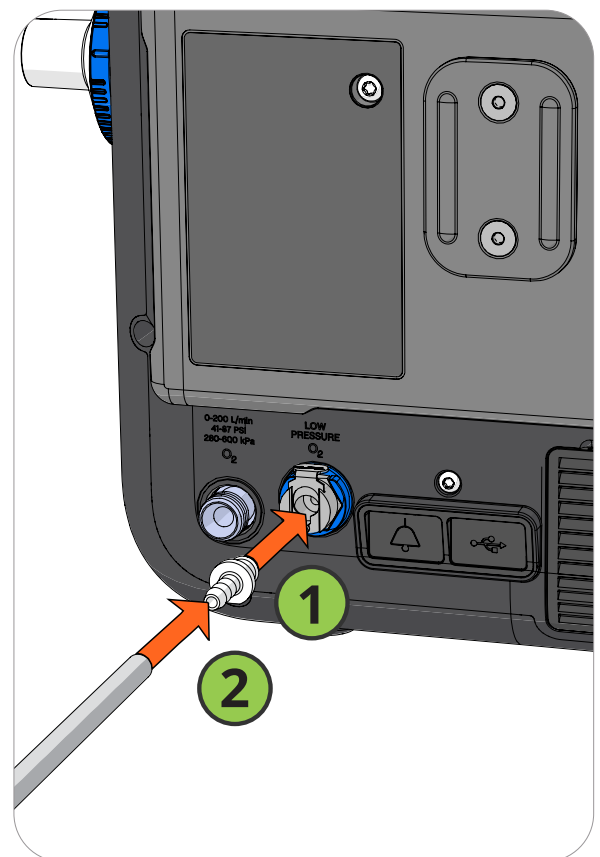

¹ When High Flow therapy is On, the FiO₂ monitor and FiO₂ alarms are also active. Deactivating High Flow therapy will also deactivate the FiO₂ monitor and alarms while using low-pressure oxygen.

Suction Setup

Depending on your device configuration, VOCSN may include an internal suction pump and a detachable Ventec Travel Suction Canister with a 300 mL capacity. When the Ventec Travel Suction Canister is full, disconnect and dispose of it as a contaminated component. The Ventec Travel Suction Canister includes a water-phobic filter that will render Suction therapy inoperable if the Ventec Travel Suction Canister overfills.

The optional Ventec External Suction Canister Adapter can be used to connect larger third-party suction canisters. See *"Accessories"* on page 204 for information.

Capable of medium vacuum and high flow, the VOCSN suction pump can be used to clear secretions from the mouth, nose, or airway of a patient using an open- or closed-suction catheter.

Removing and Reattaching the VOCSN Suction Cap

VOCSN comes with a Suction Cap to protect the suction interface port when not in use. The cap must be removed before attaching the Ventec Travel Suction Canister. Keep the cap in place whenever a suction canister or adapter is not installed.

- 1** Unlock the VOCSN Suction Cap by twisting the cap counterclockwise.
- 2** To remove the cap, pull it away from VOCSN. To install a suction canister to provide Suction therapy to the patient, see *"Connecting the Ventec Travel Suction Canister"* on page 45.
- 3** Whenever a suction canister or adapter is not installed, reattach the cap to keep the port clean. To reattach the cap, fit it over the suction interface. Orient the lock icon upright and jostle the cap into place. Lock the cap by twisting it clockwise until it stops moving.



Connecting the Ventec Travel Suction Canister

To connect and remove the Ventec Travel Suction Canister to VOCSN:

- 1** Ensure the Ventec Travel Suction Canister knob handle is in the unlocked. Place the Ventec Travel Suction Canister against the left side of VOCSN and jostle the canister so that it is flush against VOCSN.
- 2** Twist the knob handle clockwise to lock the Ventec Travel Suction Canister into place. When locked, the knob handle will be vertical.
- 3** To remove the Ventec Travel Suction Canister, twist the knob handle counter-clockwise to the unlock position, and then pull the canister away from VOCSN.

To empty the canister, see *“Emptying the Ventec Travel Suction Canister and Replacing Suction Components”* on page 164.

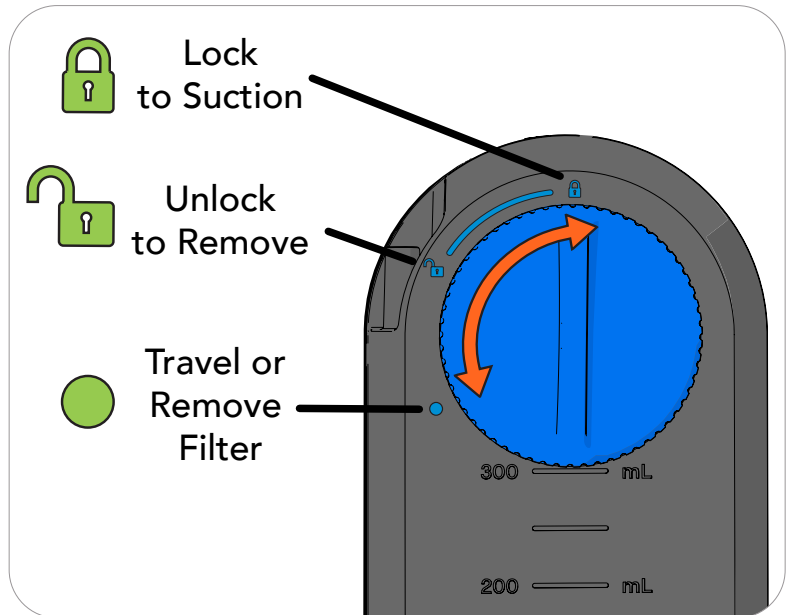

Connecting Suction Tubing to the Travel Canister

Connect suction tubing to the suction port in the Ventec Travel Suction Canister. Press the suction tubing firmly over the suction port, so that it completely covers all visible portions of the port.

Connect the other end of the suction tubing to a suction catheter.

NOTE: The Ventec Travel Suction Canister is intended for use with 1/4" diameter suction tubing compliant with ISO 10079-1. See "Accessories" on page 204 for more information.

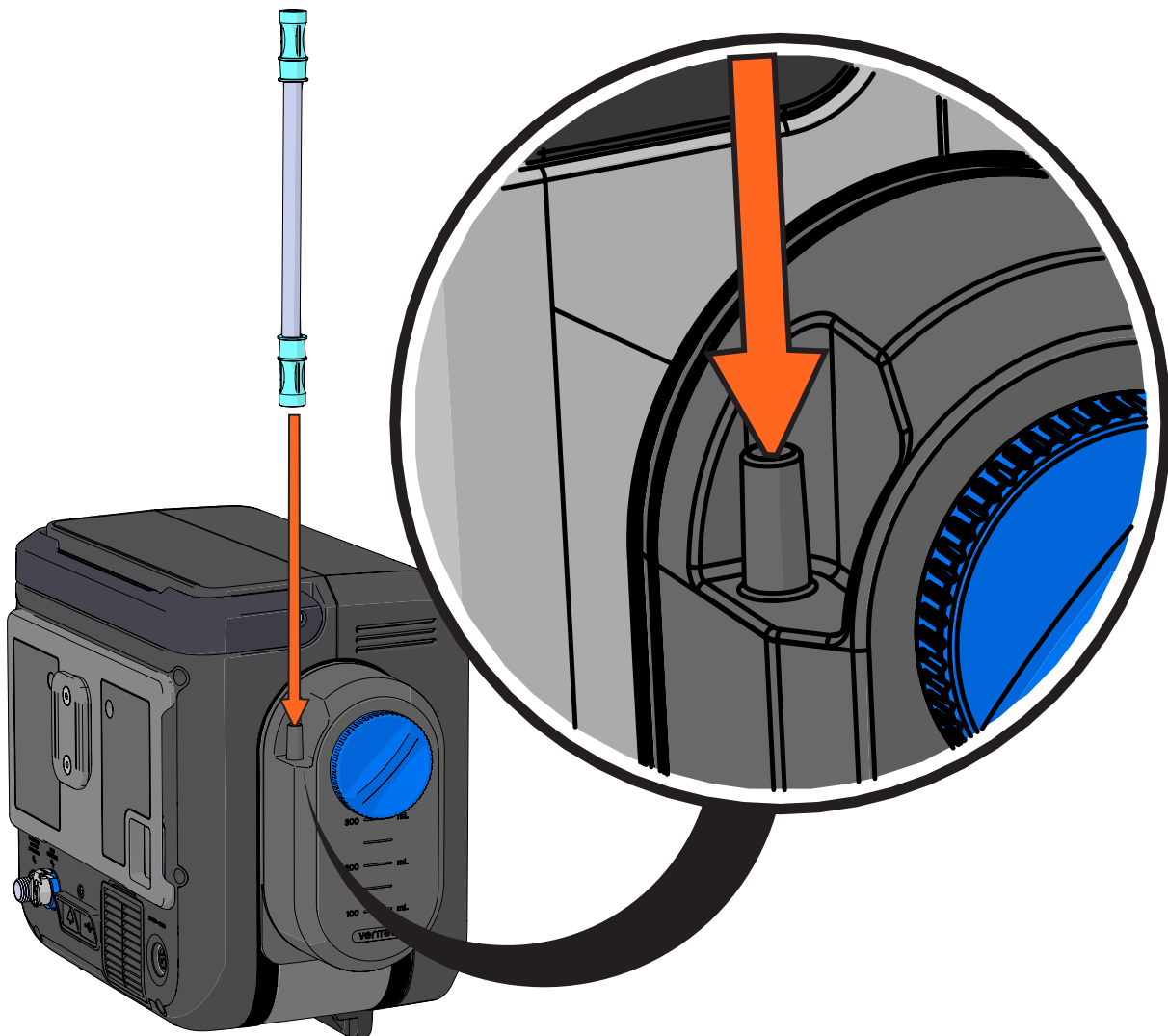

Connecting the External Suction Canister Adapter

The optional External Suction Canister Adapter (available from Ventec Life Systems) connects VOCSN to any third-party external suction canister. The external suction canister adapter includes an internal water-phobic filter that will self-seal to protect VOCSN if the external suction canister overfills.

- 1** Attach and detach the adapter by twisting it to the left (unlock position) or right (lock position).
- 2** Connect the adapter tubing to an external suction canister.
- 3** Connect a length of 1/4" diameter suction tubing to the canister.

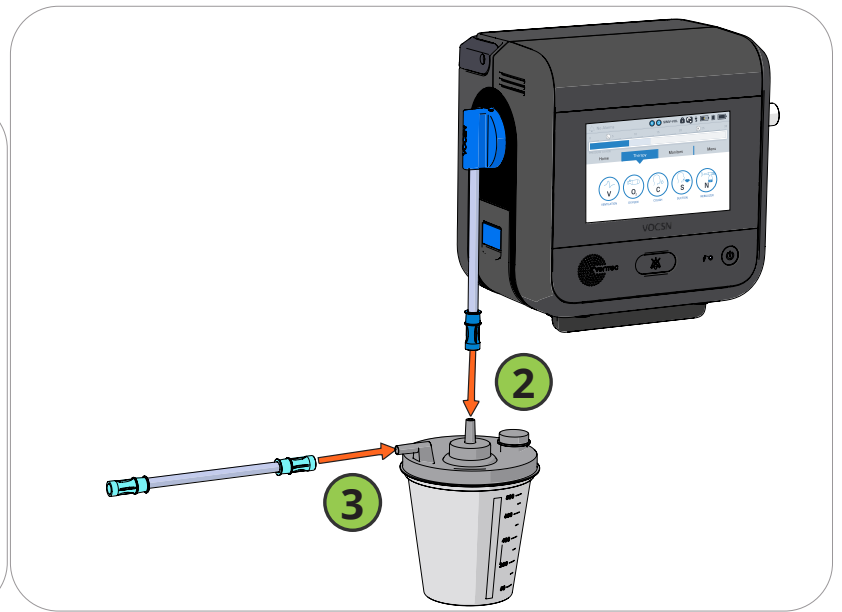
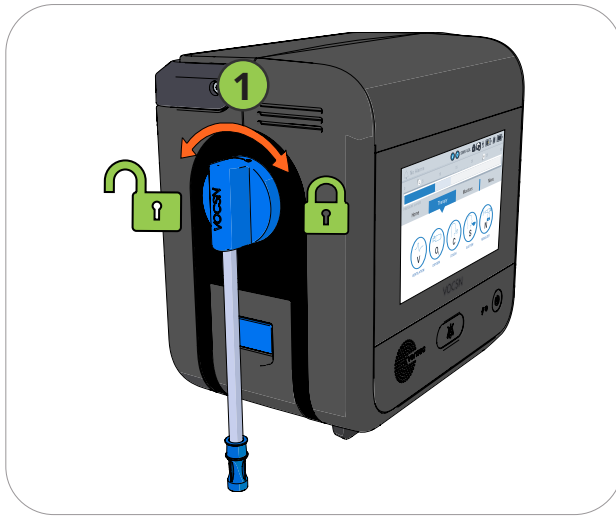

Connecting Suction Tubing to Suction Interfaces

VOCSN Suction therapy tubing can be connected to various suction interfaces, including an open- or closed-suction catheter.

- 1** Connect the tubing firmly to the suction interface, ensuring an air-tight seal.
- 2** Follow all instructions from the manufacturer of the suction interface.

To connect suction tubing to an interface used as part of the patient circuit, see *"Connecting a Closed-Suction Catheter to the Patient Circuit"* on page 38.

NOTE: If used, suction catheters should comply with ISO 8836 to ensure proper VOCSN performance.

Connecting a Nurse Call System or Remote Alarm

The remote alarm port is behind a protective rubber flap on the back of VOCSN. This port may be used to connect a remote alarm, a nurse call system, or other alarm systems that sense contact closure through a 1/4" phono jack. Only use the remote alarm port with Ventec Nurse Call cables or other cables approved by Ventec Life Systems. Follow all setup instructions provided by the remote alarm or nurse call system manufacturer.

If used with a remote alarm, position the remote alarm so that it can be heard by the clinician or caregiver at all times.

Always test the alarm immediately after installation, and periodically during use to ensure it is functioning as intended.

NOTE: Normally open nurse call systems may not cause an alarm condition when disconnected from VOCSN. Follow all instructions provided with the nurse call system to ensure safe operation.

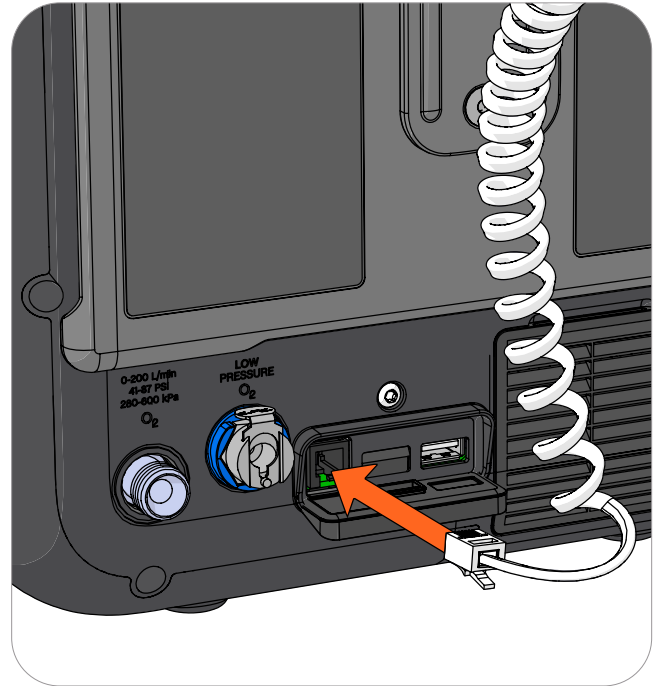

WARNING: To reduce the risk of electrical shock, ensure the Nurse Call System connected to VOCSN meets the Safety Extra Low Voltage (SELV) requirements as described in IEC 60601-1 (1988).

Safety Extra-Low Voltage (SELV): Voltage which does not exceed nominal values of 25 VAC or 60 V DC at rated supply voltage on transformer or convert, between conductors in the earth-free circuit which is isolated from the supply mains by a safety extra low voltage transformer, or by a device with equivalent separation.

Safety Extra-Low Voltage Transformer: Transformer with an output-winding which is electrically separated from earth and the body of the transformer by at least basic insulation and which is electrically separated from the input winding by an insulation at least equivalent to double insulation or reinforced insulation and which is designed to supply Safety Extra-Low Voltage circuits.

WARNING: To reduce the risk of electrical shock in the event of a failure of Nurse Call System's electrical separation from supply mains, operator should not simultaneously touch the patient and any exposed metal on the VOCSN rear housing, including: the DC power connector shell, either high or low pressure oxygen connectors, and/or the exposed metal screw above the Nurse Call/USB port.

Connecting a React DataLink™

The optional React DataLink enables wireless access to VOCSN data. The data can be accessed on the Multi-View Connect™ portal at multiviewconnect.venteclife.com. Consult the React DataLink and Multi-View Connect IFU for detailed instructions on device function and connection.

Note: Velcro strips must not obscure the label on the back of VOCSN.

Note: Only VOCSN software versions 5.00.09 or newer are compatible with the React DataLink.

Note: Make sure to adjust the VOCSN Date and Time settings to your local date and time. Refer to the Device Settings section for instructions on how to complete this action.



Running the Pre-Use Test

The VOCSN Pre-Use Test calculates the resistance and leak of the Ventec One-Circuit. Based on these calculations, VOCSN verifies the integrity of the Ventec One-Circuit, and also improves the accuracy of therapy delivered during ventilation. If used, the Pre-Use Test will also verify the connection status of the Ventec One-Circuit O2 tube.

To ensure therapy is delivered accurately, you must perform a Pre-Use Test whenever prompted, the patient circuit is changed, or the device is powered on.

WARNING: Ventilation therapy is paused during the Pre-Use Test. If Ventilation therapy is critical to patient care, provide backup ventilation for the duration of the test. To ensure patient safety, always verify Ventilation therapy is resumed when the Pre-Use Test is complete.

NOTE: Though accuracy may be reduced, VOCSN may still be used to provide ventilation therapy when the Pre-Use Test fails. If time constraints make running the test inadvisable, press the **EXIT** button to immediately initiate Ventilation therapy.

NOTE: To calculate resistance correctly, the Pre-Use Test must be performed without an HME connected to the Ventec One-Circuit.

Some control changes cause VOCSN to prompt you to run a Pre-Use Test. You may also press the **Menu** tab and then the **PRE-USE TEST** button to begin a Pre-Use Test at any time.

To run a Pre-Use Test, carefully follow the on-screen instructions. When instructed, use a clean, gloved hand to obstruct the circuit completely, as follows:

- If you are using an Active, Passive, or Valveless Ventec One-Circuit, disconnect the patient interface and block the circuit at its end.
- If you are using a Mouthpiece patient circuit, leave the mouthpiece connected, and block the open end.

If the test completes successfully, reconnect the Ventec One-Circuit to the patient and resume Ventilation therapy. If the test fails, inspect the Ventec One-Circuit configuration for leaks or improper setup. Resolve any issues with the Ventec One-Circuit, and then press **RESTART** to run the Pre-Use Test again.



Breath Types and Therapy Modes

Breath Types

Breaths can be initiated (started) and cycled (ended) by either VOCSN or the patient. Depending on the Ventilation Mode and breath control settings chosen, VOCSN may provide the patient with mandatory, assist, or spontaneous breaths.

Breath	Triggered by	Cycled by	Description
Mandatory	VOCSN	VOCSN	Mandatory breaths are initiated by VOCSN based on the set Breath Rate and delivered as pressure or volume breaths. Breaths cycle at the end of the set Inspiratory Time. If Pressure Control Flow Termination is enabled, mandatory breaths may be cycled by the patient when the flow drops to the set Flow Cycle percentage.
Assist	Patient	VOCSN	Assist breaths are initiated by the patient and delivered as pressure or volume breaths. Breaths cycle when they reach the end of the set Inspiratory Time. If Pressure Control Flow Termination is enabled, breaths may be cycled by the patient when the flow drops to the set Flow Cycle percentage.
Spontaneous	Patient	Patient	Spontaneous breaths are initiated and cycled by patient effort.

Depending on the Ventilation Mode setting, mandatory and assist breaths may be delivered to the patient as either pressure or volume breath types. When triggered, spontaneous breaths provide a set pressure to support patient demand.

NOTE: When used with active, passive, or valveless Ventec One-Circuits, VOCSN was designed for use with a humidifier or HME. All volumes and flows are expressed in BTPS unless stated otherwise.

Pressure Breaths

Mandatory and assist breaths are delivered as pressure breaths in pressure ventilation modes. VOCSN delivers pressure breaths by elevating the pressure of the Ventec One-Circuit to the set Pressure Control limit for the set Inspiratory Time.

NOTE: The maximum pressure delivered is limited to the High Pressure alarm setting minus 5 cmH₂O.

VOCSN will deliver flow during the set Inspiratory Time to reach and maintain the set Pressure Control limit. Adjusting the Rise Time control will modify the rate of flow and rate of pressure elevation.

Pressure breaths cycle at the end of the set Inspiratory Time, or when flow drops to the set Flow Cycle percentage of peak flow when PC Flow Termination is set to On.

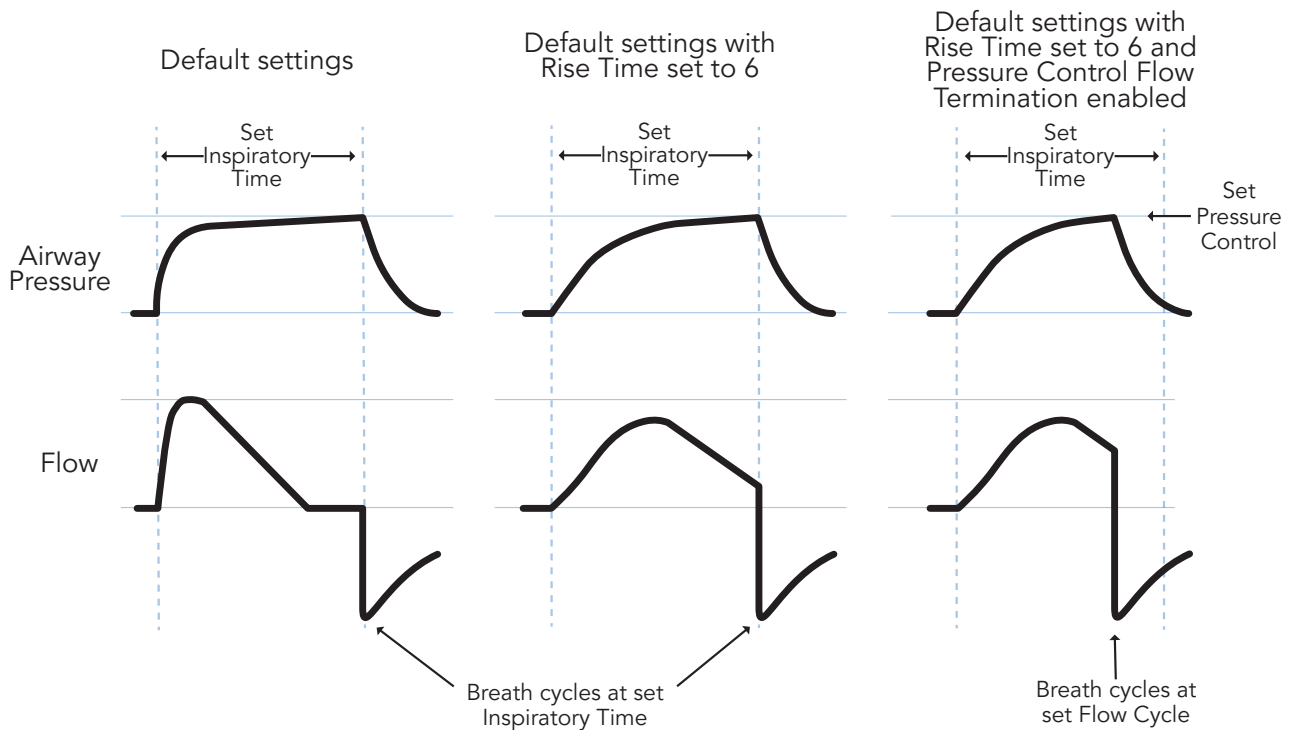

Volume Breaths

Mandatory and assist breaths are delivered as volume breaths in volume ventilation modes. Volume breaths deliver the set Tidal Volume over the set Inspiratory Time. Airway pressure is a function of patient lung resistance and compliance.

NOTE: Delivery of volume breaths to patients with extremely high airway resistance (e.g., 200 cmH₂O/L/s) and lung compliance requires high circuit pressure, which may cause the High Pressure alarm to activate before the target tidal volume is reached.

The set Tidal Volume and Inspiratory Time determine the peak flow (limited to 120 L/min). The final flow will be 50% of the peak flow, unless peak flow is below 20 L/min. When peak flow is below 20 L/min, the final flow will be 10 L/min.

Volume breaths cycle at the end of the set Inspiratory Time.

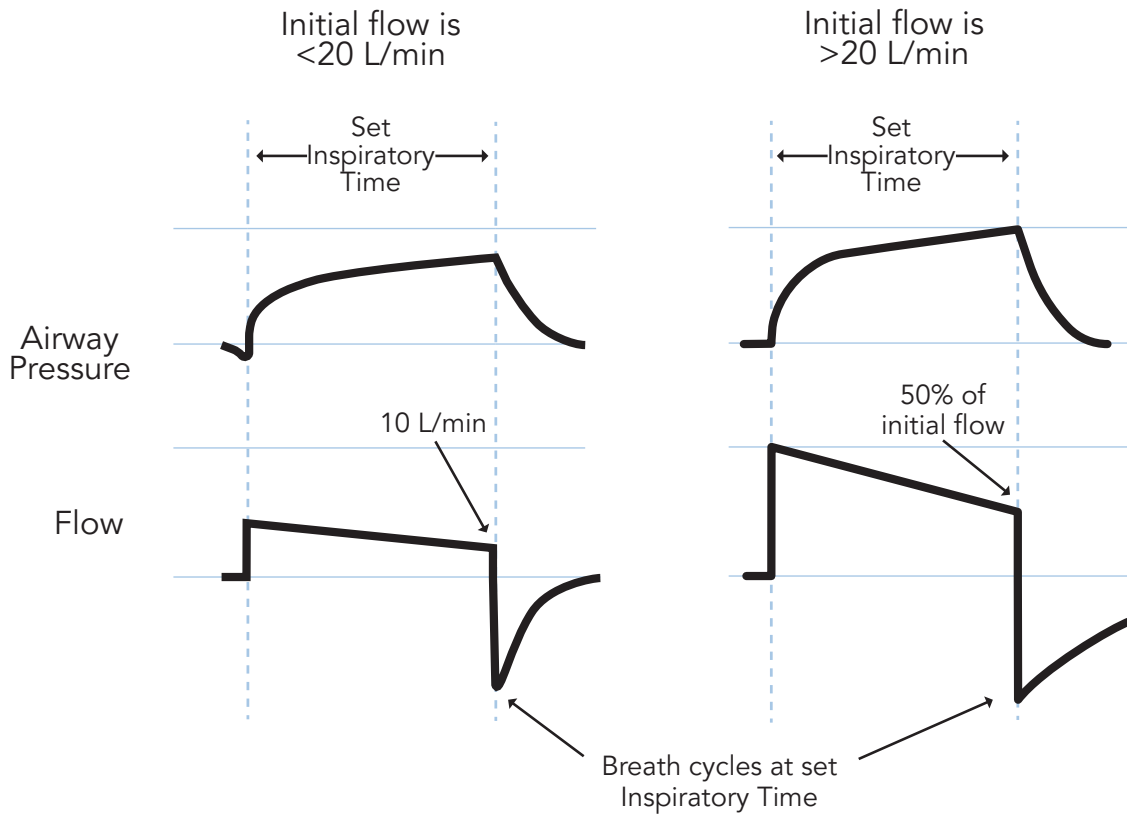

Spontaneous Breaths

Spontaneous breaths are initiated and cycled by the patient. Depending on the set Ventilation Mode, spontaneous breaths will be delivered at a set IPAP (in Bi-Level and Spontaneous modes) or at a set Pressure Support (in SIMV modes). Spontaneous breaths cycle at the set Flow Cycle percentage of peak flow, or at the Time Cycle setting, whichever is reached first.

VOCSN Ventilation Modes

VOCSN offers nine configurable Ventilation Mode settings: Bi-Level, Spontaneous, Assist/Control-Pressure, Assist/Control-Volume, SIMV-Pressure, SIMV-Volume, Vol. Targeted-PS, Vol. Targeted-PC, and Vol. Targeted-SIMV.

A breath period is the window of time used by VOCSN to determine when mandatory breaths will be delivered to the patient. A breath period is 60 seconds divided by the set Breath Rate. Breath periods begin at the start of a breath, whether patient-triggered or mandatory.

Bi-Level Mode

Bi-Level mode provides the patient with two configurable levels of pressure: IPAP (above ambient) during inhalation, and EPAP during exhalation.

NOTE: Bi-Level ventilation is not intended for use with Mouthpiece patient circuits.

In Bi-Level therapy, the patient may initiate a spontaneous breath at any time at the set Flow Trigger. If the patient does not initiate a spontaneous breath within a breath period, VOCSN will deliver a mandatory pressure breath to ensure the patient breathes at a minimum rate, set using the Breath Rate control.

Both spontaneous and mandatory breaths will be delivered at the set IPAP (above ambient). When a breath cycles, VOCSN will deliver the set EPAP.

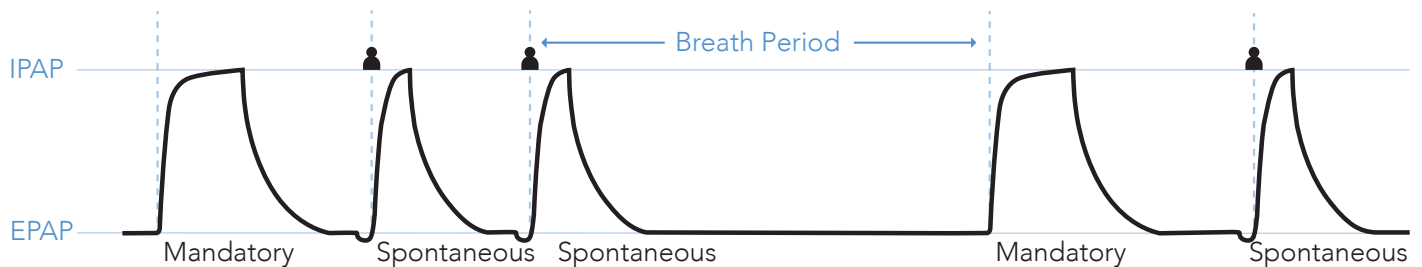

Spontaneous Mode

Spontaneous mode is used with mouthpiece patient circuits only. All breaths are spontaneous (initiated and cycled by the patient). When VOCSN detects patient effort through the mouthpiece patient circuit, the set IPAP (above ambient) is delivered. When a breath cycles, the pressure of the patient circuit drops to zero (ambient).

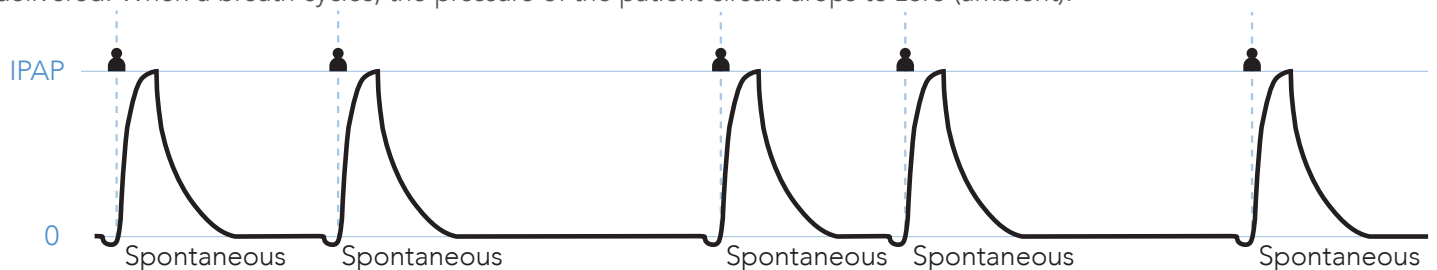

Assist/Control-Pressure Mode

Assist/Control-Pressure works one way with active, passive, and valveless circuits, and differently when VOCSN is connected to and configured to use a mouthpiece Ventec One-Circuit.

Assist/Control-Pressure with an Active, Passive, or Valveless Ventec One-Circuit

When used with an active, passive, or valveless Ventec One-Circuit, Assist/Control-Pressure mode provides mandatory and assist pressure breaths, depending on the timing of detected patient effort. Patient effort will trigger an assist pressure breath. If no patient effort is detected within a breath period, VOCSN will provide a mandatory pressure breath.

Both mandatory and assist breaths are delivered at the set Pressure Control (above PEEP)¹ over the set Inspiratory Time. When a breath cycles, the pressure of the Ventec One-Circuit drops to the set PEEP.

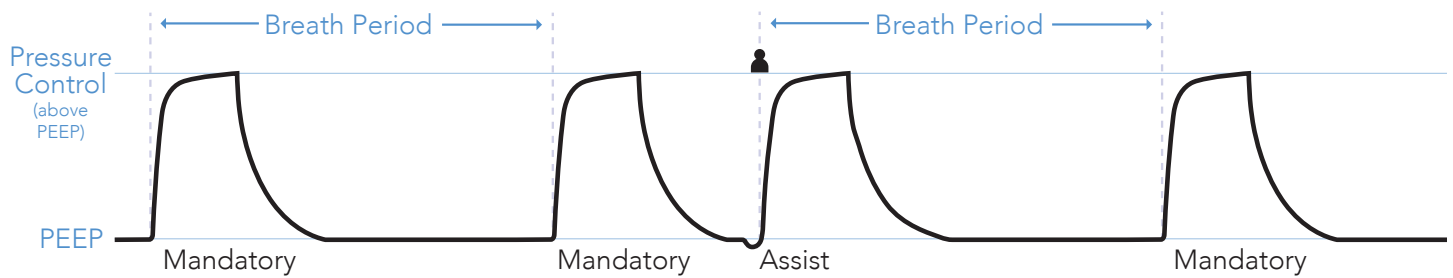

Assist/Control-Pressure with a Mouthpiece Patient Circuit

When used with a mouthpiece patient circuit, Assist/Control-Pressure mode provides assist pressure breaths when patient effort is detected.

Assist breaths are delivered at the set Pressure Control over the set Inspiratory Time. Since mouthpiece circuits are not always held in the mouth, the pressure of the patient circuit drops to zero when a breath cycles.

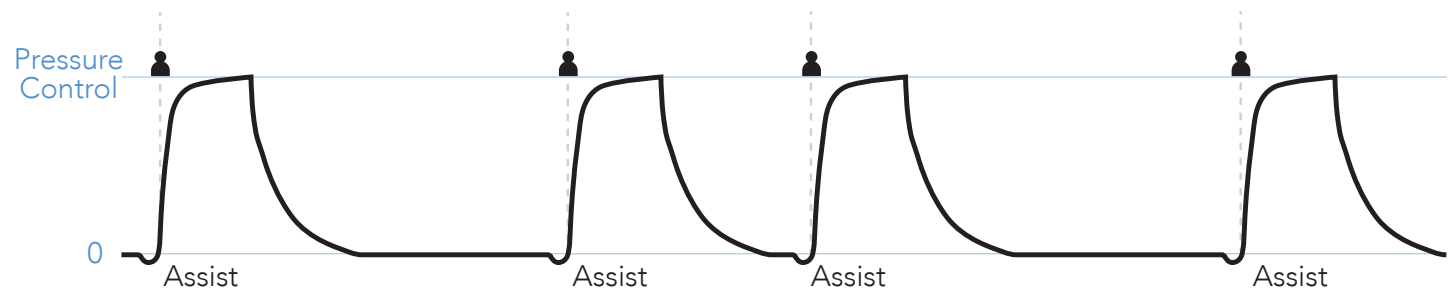

SIMV-Pressure Mode

SIMV-Pressure mode delivers pressure and spontaneous breaths through an active, passive, or valveless circuit. When patient effort is detected during a breath period, one assist breath will be delivered. Subsequent patient triggers within a breath period will result in spontaneous breaths.

If patient effort is not detected during a breath period, VOCSN will provide a mandatory pressure breath at the beginning of the next breath period.

Both mandatory and assist breaths are delivered at the set Pressure Control (above PEEP),² over the set Inspiratory Time. Spontaneous breaths are delivered at the set Pressure Support (above PEEP), and cycle with patient effort. When a breath cycles, the pressure of the Ventec One-Circuit drops to the set PEEP.

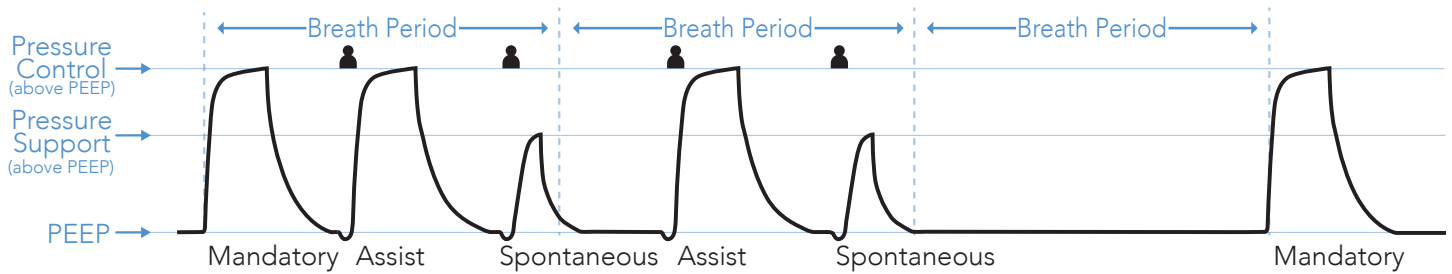

CPAP Function

VOCSN does not include a separate mode setting for CPAP. The CPAP function is achieved by setting the ventilator to SIMV-Pressure (or SIMV-Volume) mode, and setting the Breath Rate and Pressure Support to zero. All breaths are spontaneous, and are delivered at the set PEEP level.

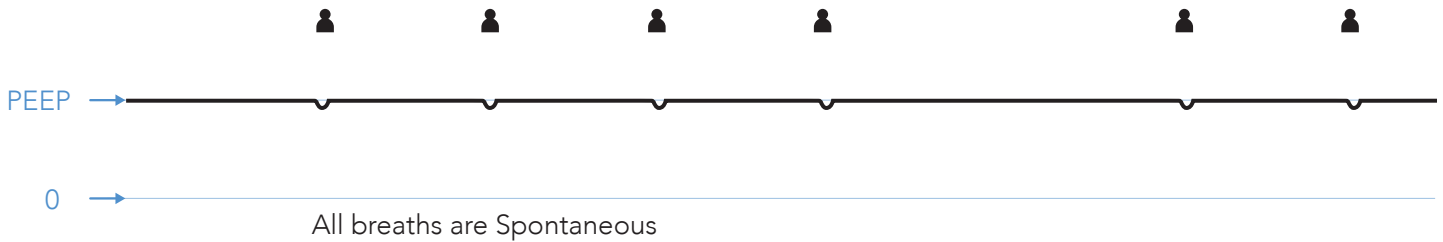

High Flow Therapy

When the Mode control is set to a SIMV mode, a High Flow option is available to provide the patient with a set flow of gas through a high flow nasal cannula or other interface. High Flow therapy is not intended for life support. Like the CPAP function in SIMV modes, there is no set Breath Rate and all breaths are spontaneous.

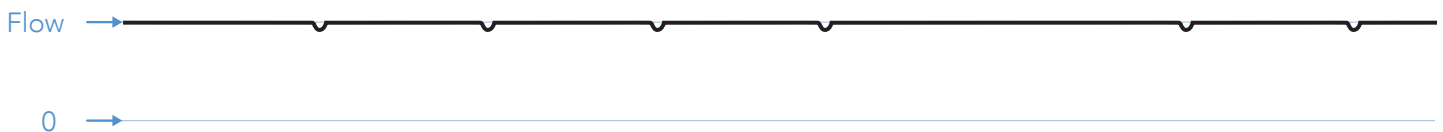

Assist/Control-Volume Mode

Assist/Control-Volume works one way with active, passive, and valveless circuits, and differently when VOCSN is connected to and configured to use a mouthpiece Ventec One-Circuit.

Assist/Control-Volume with an Active, Passive, or Valveless Ventec One-Circuit

When used with an active, passive, or valveless Ventec One-Circuit, Assist/Control-Volume mode provides mandatory and/or assist volume breaths. Patient effort will trigger an assist volume breath. If no patient effort is detected within a breath period, VOCSN will provide a mandatory volume breath.

Both mandatory and assist breaths deliver the set Tidal Volume over the set Inspiratory Time. When a breath cycles, the pressure of the Ventec One-Circuit drops to the set PEEP.

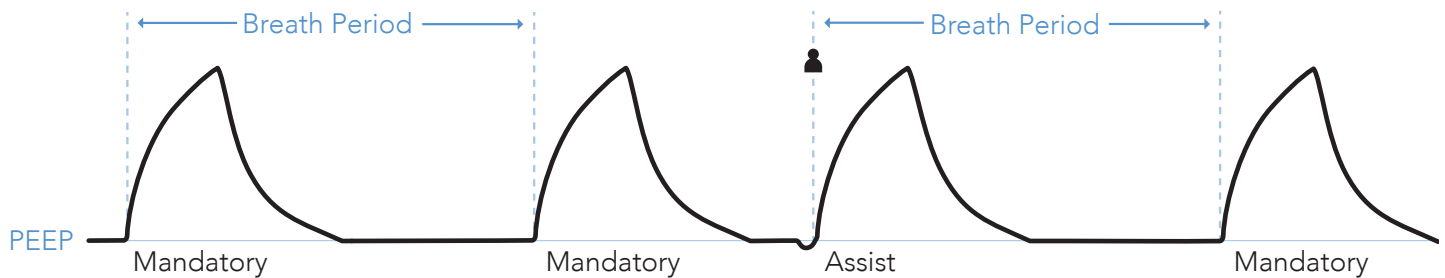

Assist/Control-Volume with a Mouthpiece Patient Circuit

When used with a mouthpiece patient circuit, Assist/Control-Volume mode provides assist volume breaths when patient effort is detected.

Assist breaths deliver the set Tidal Volume over the set Inspiratory Time. When a breath cycles, the pressure of the patient circuit drops to zero.

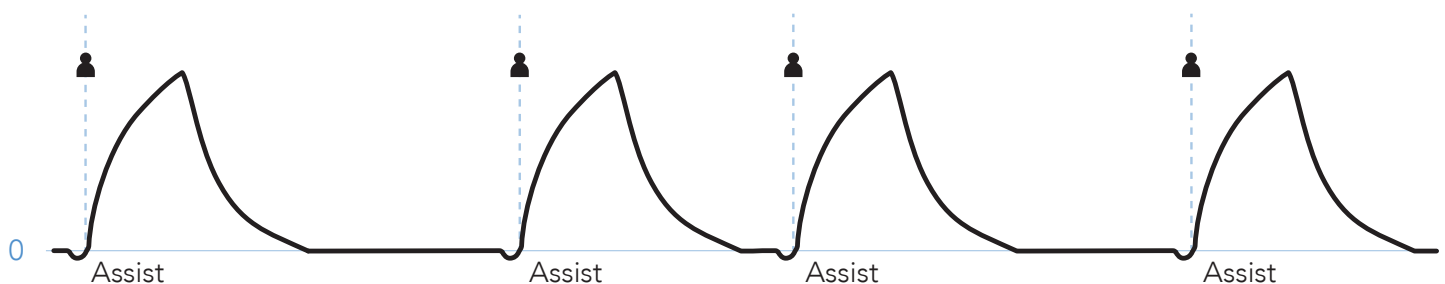

SIMV-Volume Mode

SIMV-Volume mode delivers volume and spontaneous breaths through an active, passive, or valveless Ventec One-Circuit. When patient effort is detected during a breath period, one assist breath will be delivered. Subsequent patient triggers within a breath period will result in spontaneous breaths.

If patient effort is not detected during a breath period, VOCSN will provide a mandatory volume breath at the beginning of the next breath period.

Both mandatory and assist breaths deliver the set Tidal Volume over the set Inspiratory Time. Spontaneous breaths are delivered at the set Pressure Support plus PEEP,³ and cycle with patient effort. When a breath cycles, the pressure of the Ventec One-Circuit drops to the set PEEP.

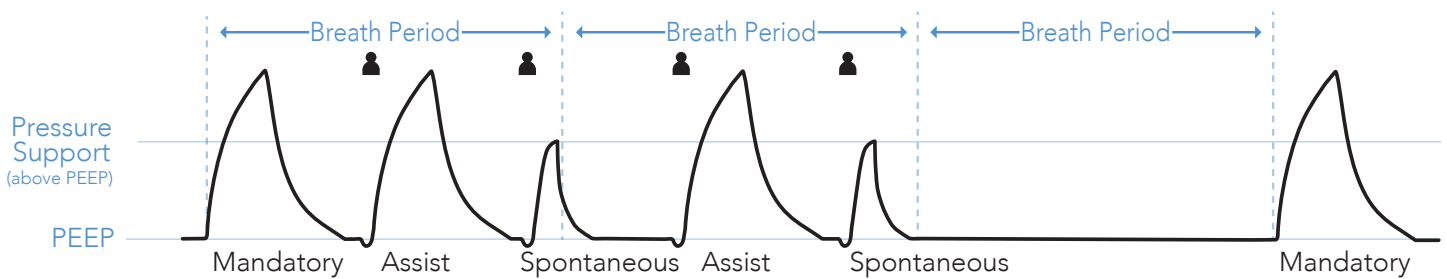

CPAP Function

VOCSN does not include a separate mode setting for CPAP. The CPAP function is achieved by setting the ventilator to SIMV-Volume (or SIMV-Pressure) mode, and setting the Breath Rate and Pressure Support to zero. All breaths are spontaneous, and are delivered at the set PEEP level.

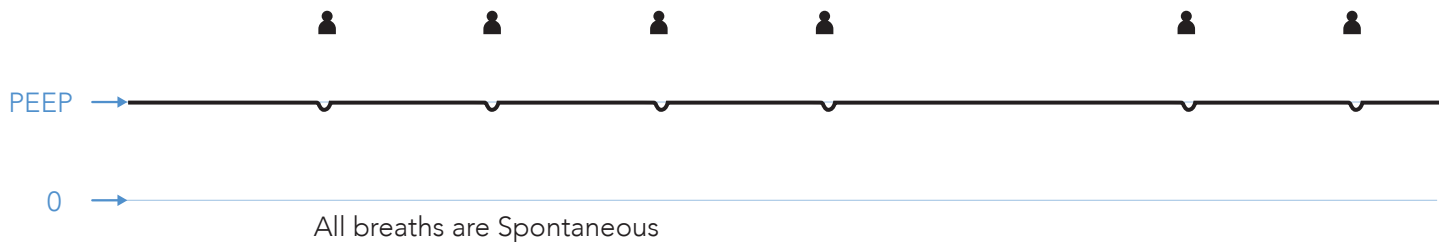

High Flow Therapy

When the Mode control is set to a SIMV mode, a High Flow option is available to provide the patient with a continuous, set flow of gas through a high flow nasal cannula or other interface. High Flow therapy is not intended for life support. Like the CPAP function in SIMV modes, there is no set Breath Rate and all breaths are spontaneous.

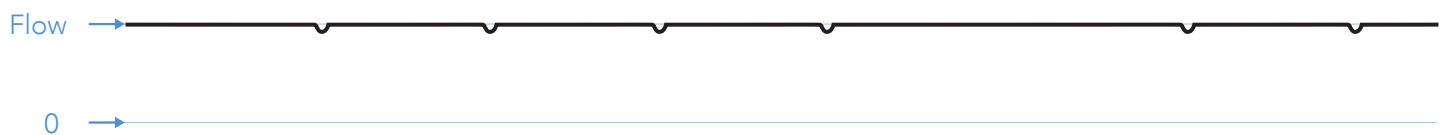

Volume Targeted Ventilation Overview

The Volume Targeted ventilation modes deliver a set Tidal Volume to the patient by adjusting the pressure control target on a breath-to-breath basis. These modes may be useful in maintaining consistent volume delivery in the face of changing patient conditions such as compliance.

In Volume Targeted modes, VOCSN delivers a an initial breath to the patient, and then automatically adjusts the therapy to achieve and maintain the target Tidal Volume. The first breath is delivered as a pressure control breath at the set Pres. Minimum. VOCSN then measures and calculates the pressure required to deliver the set Tidal Volume to the patient for subsequent breaths.

With each breath, VOCSN makes adjustments to the delivered pressure to achieve the target Tidal Volume. The adjustment rate can be set using the Pres. Adj. Rate control. Setting the Pres. Adj. Rate control to Slow will increment breaths by up to ± 1 cmH₂O per breath. The Fast setting will increment breaths by up to ± 3 cmH₂O per breath.

NOTE: VOCSN will pause calculations during activation of the High Pressure, Check Patient Circuit, or Patient Circuit Disconnect alarm, and then resume them once the alarm is resolved.

During Volume Targeted ventilation, the delivered pressure is limited to 5 cmH₂O below the High Pressure alarm setting, or 50 cmH₂O (whichever is less).

NOTE: In some cases, the High Pressure limit may prevent VOCSN from delivering the entirety of the set Tidal Volume to the patient. Ventec Life Systems recommends using the Low Minute Volume alarm as a way to detect this condition.

NOTE: The Pres. Minimum setting may cause VOCSN to deliver more volume than intended by the Tidal Volume setting. Ventec Life Systems recommends using the High Minute Volume alarm to detect this condition.

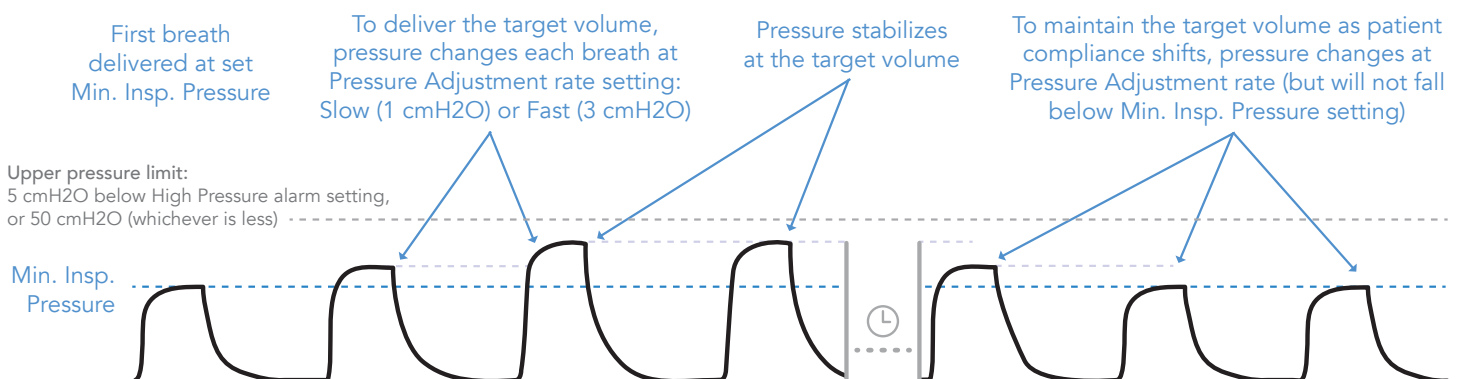

Vol. Targeted-PS Mode

Vol. Targeted-PS is a Volume Targeted mode of ventilation. The patient may initiate a spontaneous breath at any time. It provides the patient with two configurable levels of pressure: the set PEEP, and the pressure required to maintain the set Tidal Volume target.

Vol. Targeted-PS with an Active, Passive, or Valveless Ventec One-Circuit

When used with an active, passive, or valveless Ventec One-Circuit, Vol. Targeted-PS mode allows the patient to initiate a spontaneous breath at any time at the set Flow Trigger. If the patient does not initiate a spontaneous breath within a breath period, VOCSN will deliver a mandatory breath to ensure the patient breathes at a minimum rate, set using the Breath Rate control.

Both spontaneous and mandatory breaths are delivered and adjusted on a breath-to-breath basis to achieve and maintain the target Tidal Volume. When a breath cycles, VOCSN will deliver the set PEEP.

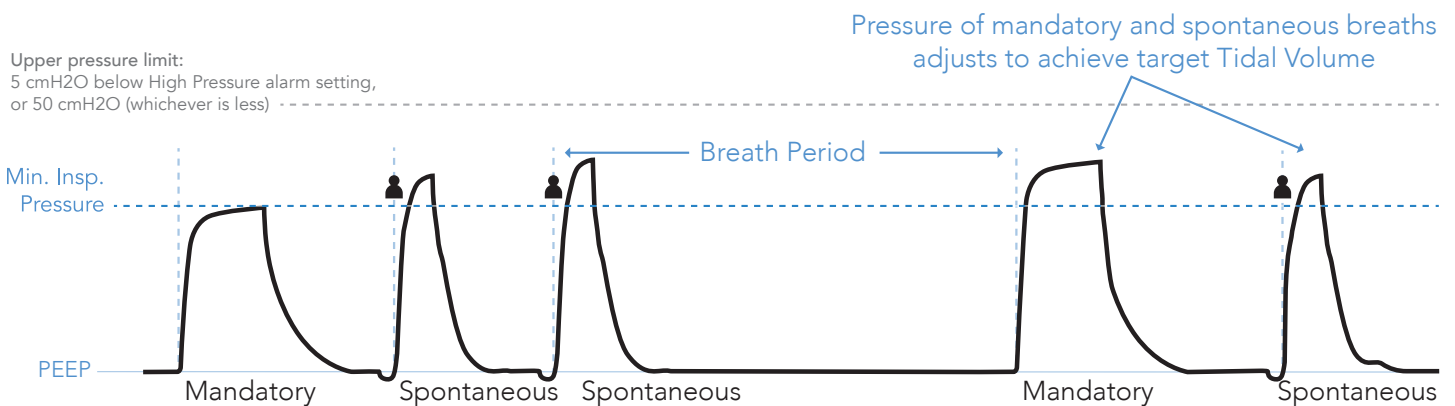

Vol. Targeted-PS with a Mouthpiece Patient Circuit

During ventilation with a Mouthpiece patient circuit, all breaths are spontaneous (initiated and cycled by the patient). When VOCSN detects patient effort through the mouthpiece patient circuit, pressure is delivered and adjusted each breath to achieve the target Tidal Volume. When a breath cycles, the pressure of the mouthpiece patient circuit drops to zero (ambient).

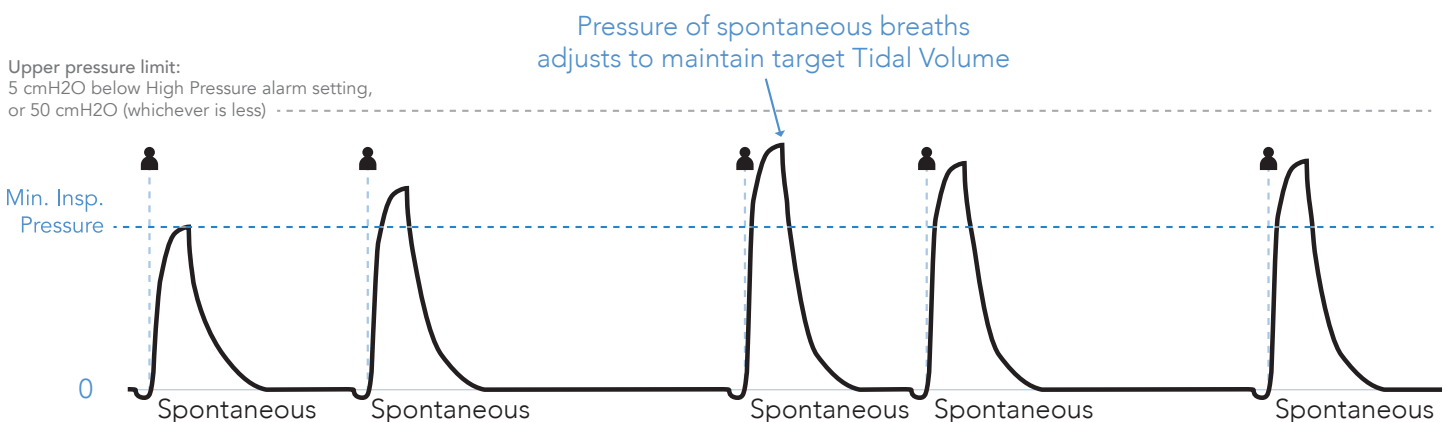

Vol. Targeted-PC Mode

Vol. Targeted-PC with an Active, Passive, or Valveless Ventec One-Circuit

When used with an active, passive, or valveless Ventec One-Circuit, Vol. Targeted-PC mode provides mandatory and assist pressure breaths, depending on the timing of detected patient effort. Patient effort will trigger an assist pressure breath. If no patient effort is detected within a breath period, VOCSN will provide a mandatory pressure breath.

Both mandatory and assist breaths are delivered and adjusted on a breath-to-breath basis to achieve and maintain the target Tidal Volume. When a breath cycles, the pressure of the Ventec One-Circuit drops to the set PEEP.

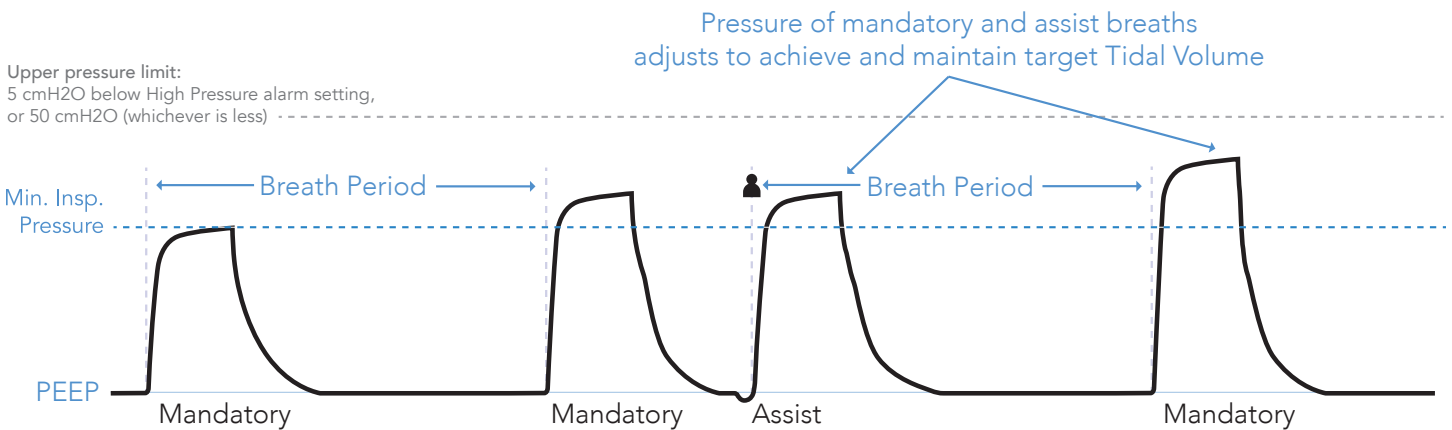

Assist/Control-Pressure with a Mouthpiece Patient Circuit

When used with a mouthpiece patient circuit, Vol. Targeted-PC mode provides assist pressure breaths when patient effort is detected.

Assist breaths are delivered and adjusted on a breath-to-breath basis to achieve and maintain the target Tidal Volume over the set Inspiratory Time. When a breath cycles, the pressure of the mouthpiece patient circuit drops to zero (ambient).

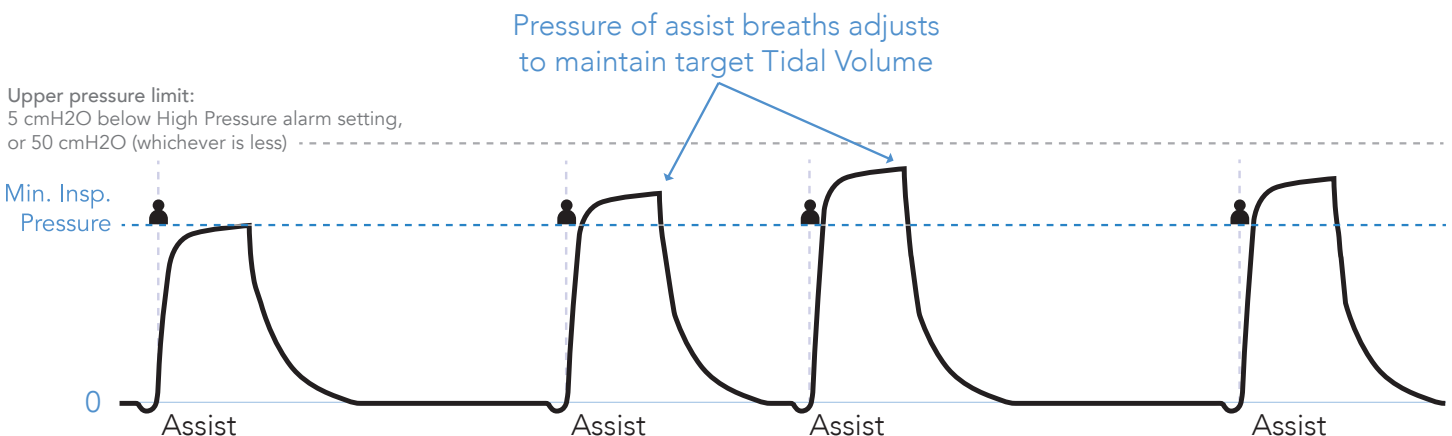

Vol. Targeted-SIMV Mode

Vol. Targeted-SIMV mode delivers volume targeted breaths through an active, passive, or valveless circuit. When patient effort is detected during a breath period, one assist breath will be delivered. Subsequent patient triggers within a breath period will result in spontaneous breaths.

If patient effort is not detected during a breath period, VOCSN will provide a mandatory pressure breath at the beginning of the next breath period.

Both mandatory and assist breaths are delivered and adjusted to achieve the set Tidal Volume, over the set Inspiratory Time. Spontaneous breaths are delivered at the set Pressure Support (above PEEP), and cycle with patient effort. When a breath cycles, the pressure of the Ventec One-Circuit drops to the set PEEP.

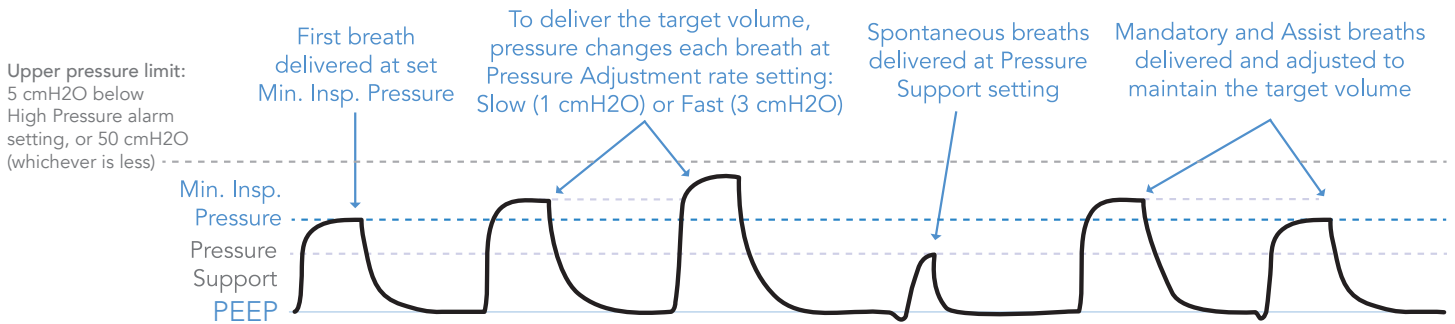

Comparable Ventilation Modes

The VOCSN critical care ventilator provides a comprehensive set of ventilation modes to meet patient needs during invasive, non-invasive and mouthpiece ventilation. The reference list below illustrates how to set your preferred ventilation mode.

Comparable Volume Ventilation Modes

Ventilation Mode or Feature	Equivalent VOCSN Mode Settings	Additional VOCSN Controls
AC-Volume (Assist/Control) VC (Volume Control)	<ul style="list-style-type: none"> • Set Mode to AC-Volume • Set Breath Rate • Set Flow Trigger to On 	<ul style="list-style-type: none"> • Inspiratory time • Tidal Volume • PEEP • Sigh
SIMV-Volume or SIMV (Synchronized Intermittent Mandatory Ventilation) +/- Pressure Support	<ul style="list-style-type: none"> • Set Mode to SIMV-Volume • Set Breath Rate • Set Flow Trigger • Set Pressure Support (measured above the set PEEP) 	<ul style="list-style-type: none"> • Inspiratory Time • Tidal Volume (for mandatory breaths) • PEEP • Flow Cycle • Time Cycle • Rise Time • Apnea Rate • Sigh
CV-Volume (Control Ventilation)	<ul style="list-style-type: none"> • Set Mode to AC-Volume • Set Breath Rate • Set Flow Trigger to Off 	<ul style="list-style-type: none"> • Inspiratory time • Tidal Volume • PEEP • Sigh

Comparable Pressure Ventilation Modes (Including Volume-Targeted Ventilation)

Ventilation Mode or Feature	Equivalent VOCSN Mode Settings	Additional VOCSN Controls
AC-Pressure (Assist/Control) PC (Pressure Control)	<ul style="list-style-type: none"> • Set Mode to AC-Pressure • Set Breath Rate • Set Flow Trigger 	<ul style="list-style-type: none"> • Inspiratory Time • PEEP • Pressure Control (measured above the set PEEP) • Pressure Control Flow Termination • Flow Cycle • Rise Time
PRVC (Pressure Regulated Volume Control)	<ul style="list-style-type: none"> • Set Mode to Vol. Targeted-PC • Set Breath Rate • Set Pres. Minimum and Pres. Adj. Rate • Set Flow Trigger • Set High Pressure Alarm 5 cmH₂O above desired maximum pressure 	<ul style="list-style-type: none"> • Inspiratory Time • Target Volume • PEEP • Pressure Control Flow Termination • Flow Cycle • Rise Time
SIMV-Pressure or PC-SIMV (Synchronized Intermittent Mandatory Ventilation) +/- Pressure Support	<ul style="list-style-type: none"> • Set Mode to SIMV-Pressure • Set Breath Rate • Set Flow Trigger • Set Pressure Control • Set Pressure Support (measured above the set PEEP) 	<ul style="list-style-type: none"> • Inspiratory Time • PEEP • Pressure Control Flow Termination • Flow Cycle • Time Cycle • Rise Time
SIMV + PRVC (Synchronized Intermittent Mandatory Ventilation) + (Pressure Regulated Volume Control)	<ul style="list-style-type: none"> • Set Mode to Vol. Targeted-SIMV • Set Breath Rate • Set Pres. Minimum and Pres. Adj. Rate • Set Flow Trigger • Set High Pressure Alarm 5 cmH₂O above desired maximum pressure 	<ul style="list-style-type: none"> • PEEP • Tidal Volume • Pressure Support (measured above the set PEEP) • Inspiratory Time • Pressure Control Flow Termination • Flow Cycle • Time Cycle • Rise Time

Comparable Non-Invasive Ventilation Modes

Ventilation Mode or Feature	Equivalent VOCSN Mode Settings	Additional VOCSN Controls
S/T (Spontaneous/Timed)	<ul style="list-style-type: none"> • Set Mode to Bi-Level • Set Breath Rate • Set Flow Trigger 	<ul style="list-style-type: none"> • Inspiratory Time • EPAP • IPAP (measured from a baseline of 0 cmH2O) • Flow Cycle • Time Cycle • Rise Time
AVAPS™, PRVS (Average Volume Assured Pressure Support) (Pressure Regulated Volume Support)	<ul style="list-style-type: none"> • Set Mode to Vol. Targeted-PS • Set Breath Rate • Set Pres. Minimum and Pres. Adj. Rate • Set Flow Trigger • Set High Pressure Alarm 5 cmH2O above desired maximum pressure 	<ul style="list-style-type: none"> • Inspiratory Time • PEEP • Tidal Volume • Flow Cycle • Time Cycle • Rise Time
T (Timed)	<ul style="list-style-type: none"> • Set Mode to AC-Pressure • Set Breath Rate • Set Flow Trigger to Off • Set Pressure Control Flow Termination to Off 	<ul style="list-style-type: none"> • Inspiratory Time • PEEP • Pressure Control (measured above the set PEEP) • Rise Time
Pressure Support S (Spontaneous)	<ul style="list-style-type: none"> • Set Mode to SIMV-Pressure or SIMV-Volume • Set Breath Rate to 0 • Set Pressure Support 	<ul style="list-style-type: none"> • Inspiratory Time (Apnea backup) • Pressure Control (Apnea backup if SIMV-Pressure) • Tidal Volume (Apnea backup if SIMV-Volume) • PEEP • Flow Cycle • Time Cycle • Rise Time • Apnea Rate
CPAP (Continuous Positive Airway Pressure)	<ul style="list-style-type: none"> • Set Mode to SIMV-Pressure or SIMV-Volume • Set Breath Rate to 0 • Set PEEP to desired CPAP level • Set Pressure Support to 0 	<ul style="list-style-type: none"> • Inspiratory Time (Apnea backup) • Pressure Control (Apnea backup if SIMV-Pressure) • Tidal Volume (Apnea backup if SIMV-Volume) • Flow Cycle • Time Cycle • Rise Time • Apnea Rate

The Touchscreen

Use the VOCSN touchscreen to configure and operate the device, as well as monitor the patient. This chapter provides an overview of the information and controls available on each of the four main tabbed navigation screens.

NOTE: If VOCSN controls become difficult to select, use the Calibrate Touchscreen control to recalibrate the touchscreen sensor. See *“Available Device Settings”* on page 102.

Locking the Touchscreen

To lock the VOCSN touchscreen and protect against accidental button presses, press and hold the lock screen button in the status bar for three seconds. The icon will change to indicate the screen is locked, and a pop-up message will appear when the screen is touched.

To unlock the touchscreen, press and hold the lock screen icon in the status bar for 3 seconds again.

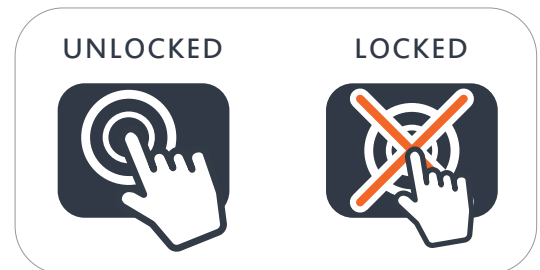

Quick View

The Quick View menu provides streamlined access to commonly used VOCSN therapies and features. Use the small arrow near the manometer to expand the Quick View menu and select from up to eight actions.

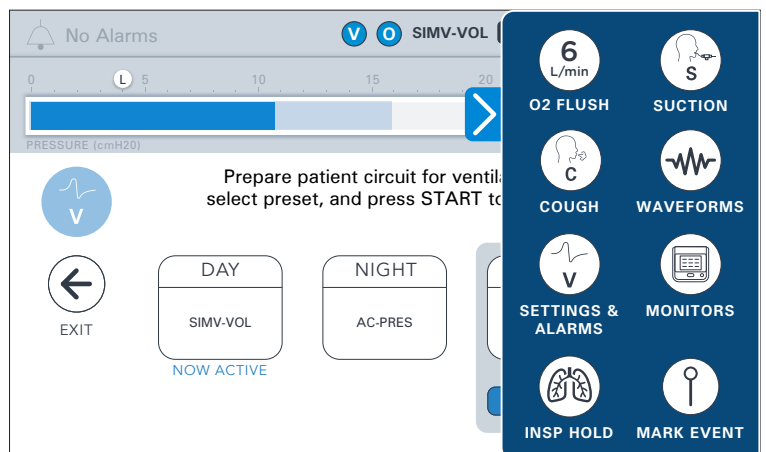

The Status Bar

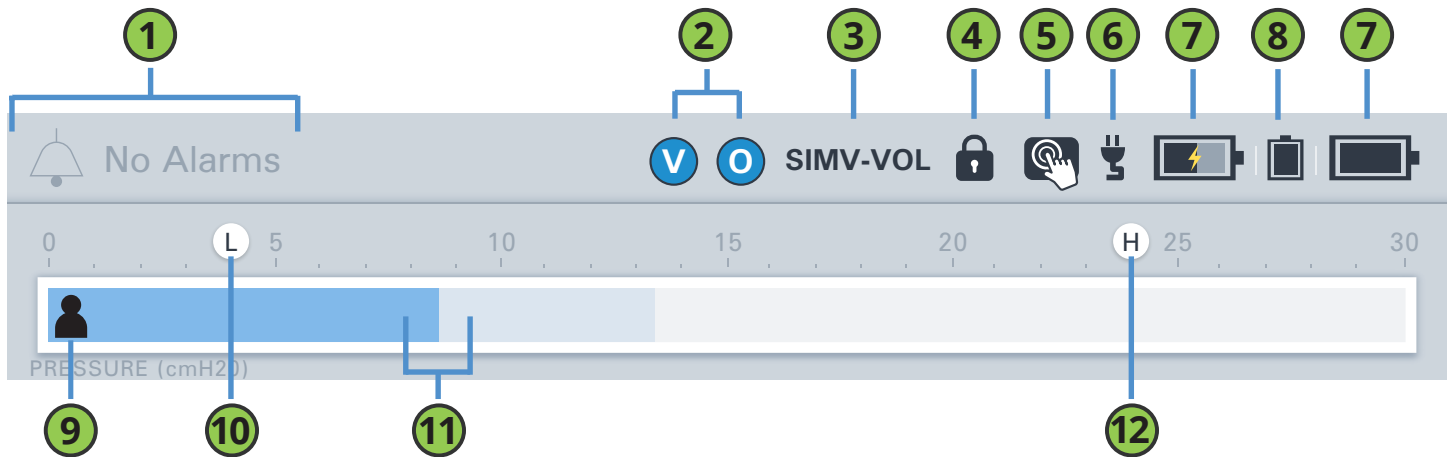

The status bar remains at the top of the screen during VOCSN use. The status bar includes the following indicators:

Description	
1	Alarm indicator. If an alarm condition occurs, the name of the alarm will display, along with a visual (color) indicator of alarm severity. Press the alarm indicator at any time to access the VOCSN Alarm and Event Logs. See <i>"The Alarm Log"</i> on page 115 and <i>"The Event Log"</i> on page 116 for more information.
2	Therapy indicator. The active therapy (Ventilation, Oxygen, Cough, Suction, and/or Nebulizer) will appear as an icon.
3	Ventilation Mode indicator. The active Ventilation Mode control setting displays as an abbreviation. See <i>"VOCSN Ventilation Modes"</i> on page 55 for a description of each available mode.
4	Clinician Unlock indicator. When VOCSN is in Clinician Unlock mode, an unlocked padlock appears on the top of the touchscreen. While VOCSN is locked, a locked padlock is displayed.
5	Screen Lock button. Press and hold the icon for 3 seconds to lock or unlock the VOCSN touchscreen. When locked, an orange "X" will appear in the icon, and the screen will be protected from accidental button presses.
6	External power indicator. A plug icon will appear and remain on the top of the screen when VOCSN is connected to external power.
7	Removable battery indicators. Two battery icons indicate the charging status and remaining battery power of each of the two removable batteries. The icon on the left indicates the status of the battery installed in the left battery well. The icon on the right indicates the status of the battery installed in the right battery well. See <i>"Glossary of Indicators"</i> on page 178 for more information.
8	Internal battery indicator. A battery icon indicates the charging status and remaining battery power of the internal battery. If the icon fill is below 50% (turns yellow) or below 33% (turns red), find an external source of power immediately. See <i>"Glossary of Indicators"</i> on page 178 for more information.
9	Patient triggered indicator. This icon will appear if the current breath is triggered by patient effort to breathe.
10	Low Pressure alarm indicator. This icon marks the set Low Pressure alarm limit.
11	Pressure monitor. This pressure manometer will increase (to the right) and decrease (to the left) as breaths are delivered to the patient. The dark blue bar represents the pressure delivered during the current breath. The light blue bar represents the peak pressure delivered during the previous breath.
12	High Pressure alarm indicator. This icon marks the set High Pressure alarm limit.

The Home Screen

The Home screen displays three configurable monitors (for example, Breath Rate, Tidal Volume, and the active Ventilation therapy Preset).

The three monitors configured to display on the top row of the Monitors tab will appear on the Home screen.

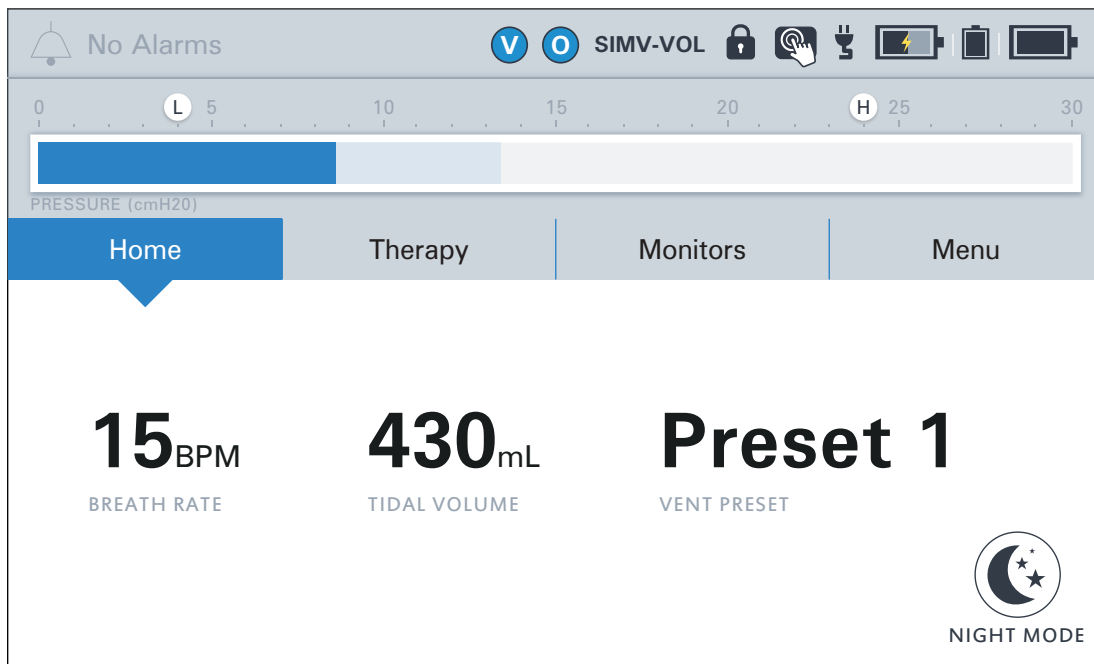

Night Mode and Day Mode

Use the Home screen to change between Night Mode and Day Mode.

- 1 Press the NIGHT MODE button on the Home screen to dim the LCD display. The screen will remain dimmed while in use.
- 2 Press DAY MODE to restore full screen brightness.

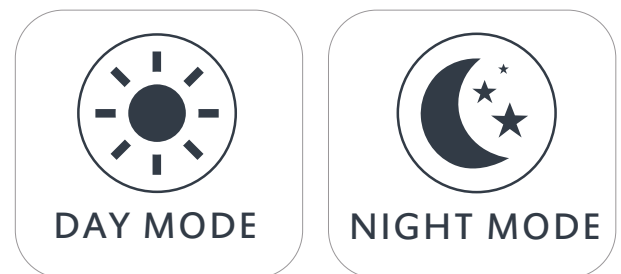

The Therapy Screen

Use the Therapy screen to configure and start Ventilation, and the optional Oxygen, Cough, Suction, or Nebulizer therapies. Your therapy screen will show the therapies available, depending on your product configuration.

NOTE: Ventilation continues during Oxygen, Suction, and Nebulizer therapy. Ventilation is temporarily suspended during Integrated Cough Assistive Therapy (ICAT), and then automatically resumes after its completion.

NOTE: Only one of following therapies can be delivered by VOCSN at one time: Oxygen (from the internal O₂ Concentrator or a high-pressure oxygen source), Suction, or Nebulizer. For a full list of VOCSN therapy interactions, see *“VOCSN Therapy Interactions” on page 103*. If uninterrupted Oxygen therapy is critical to a patient’s care, find an alternate means of providing Suction, Nebulizer, or Oxygen therapy.

Pressing any of the five therapy buttons will display an option to start the selected therapy, as well an option to configure how it is delivered. See *“Controls and Settings” on page 75* and *“Operating Instructions” on page 146* for more detailed instructions on enabling, configuring, and starting VOCSN therapies.

NOTE: If Cough, Suction, or Nebulizer therapy is disabled, the corresponding therapy button will appear in gray and become inactive. See *“Enabling and Disabling Prescribed Therapies” on page 89* to enable or disable a therapy.

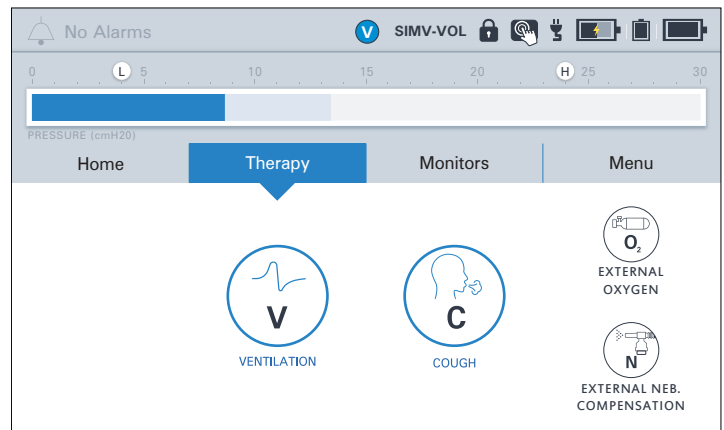
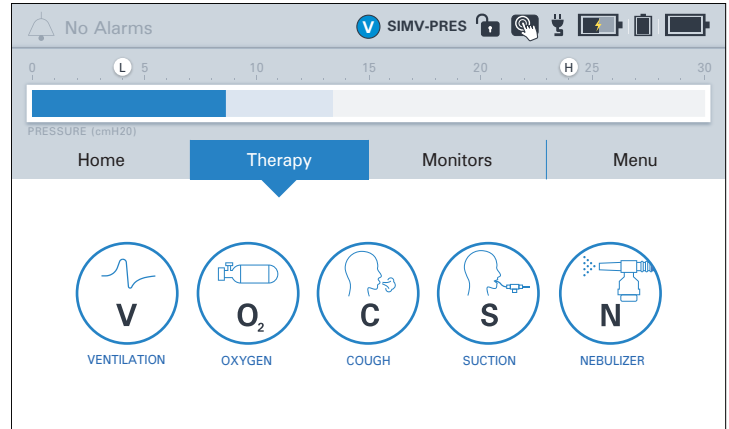

The Monitors Screen

The Monitors screen displays measured or calculated information about delivered Ventilation and Oxygen therapy. Use the **CUSTOMIZATION** button to choose which display on the screen.

To aid clinicians charting activities, an additional page of control settings is visible from the Monitors screen. Press the down arrow at the bottom of the Monitors screen to view currently active Ventilation and Oxygen therapy control settings. The controls listed on this page are configurable using the **CUSTOMIZATION** button.

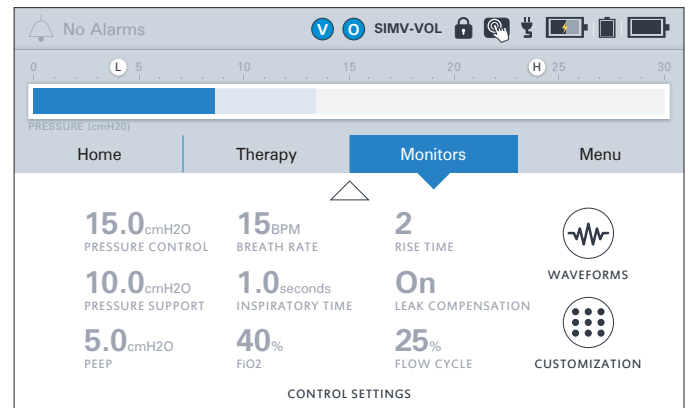
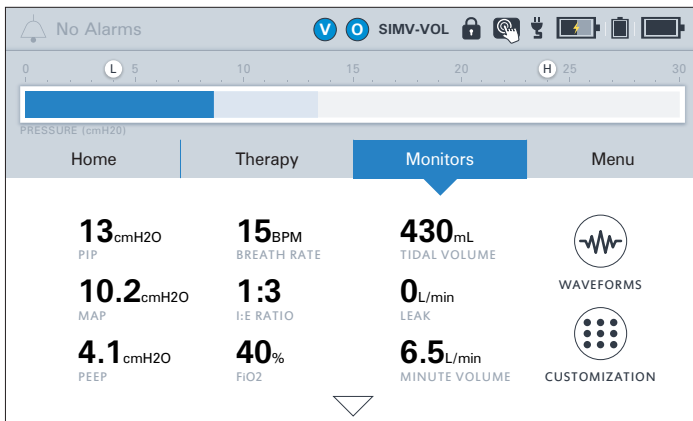

The Customization Button

The monitors and controls displayed on this screen are configurable. Press the **CUSTOMIZATION** button on each page to configure the layout and content of the Monitors screen.

The three monitors configured to display on the top row of the Monitors tab will appear on the Home screen. See *"Monitor Screen Customization"* on page 122 for detailed instructions.

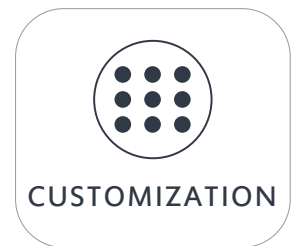

The Waveforms Button

Press the **WAVEFORMS** button on the right side of the screen to display the real-time flow, pressure, and volume waveforms delivered during Ventilation therapy. Two of these three waveforms will display at a time. These waveform displays can be scaled, paused, and resumed as appropriate for monitoring the patient.



The Menu Screen

The Menu screen provides access to additional system settings and features. This section includes a description of the information and controls accessible through each button on the Menu screen.

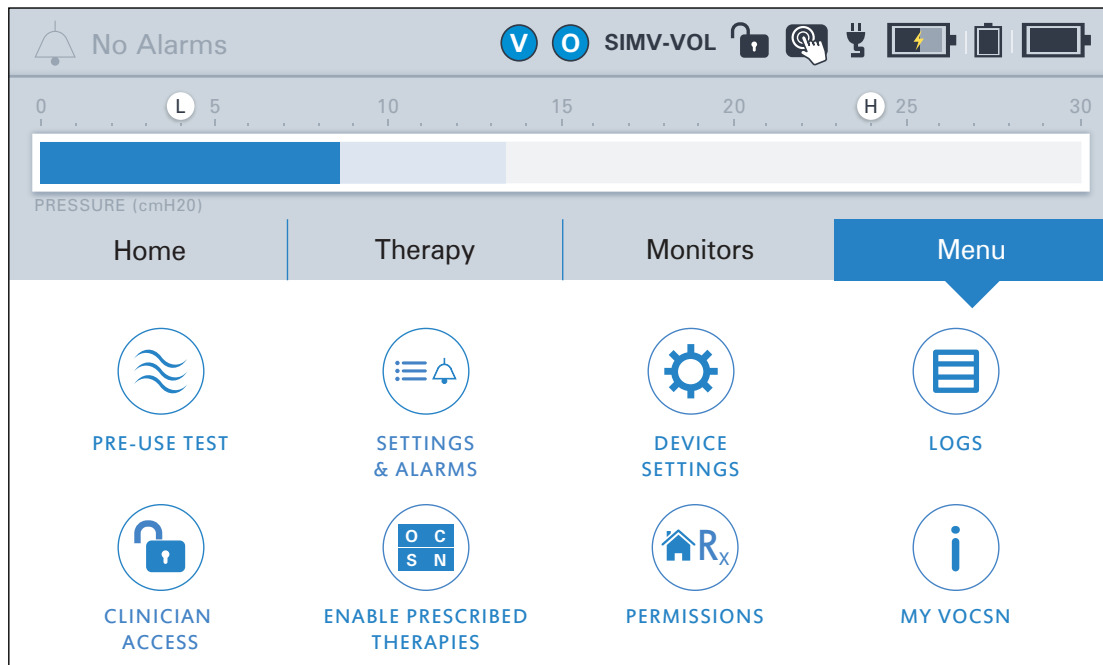

The Pre-Use Test Button

Press the **PRE-USE TEST** button to run a user-initiated Pre-Use Test. Perform a Pre-Use Test any time a Ventilation therapy control or the Ventec One-Circuit is modified, affecting the delivered Ventilation therapy.

See *“Running the Pre-Use Test”* on page 50 for more information.

NOTE: If Ventilation therapy is critical to patient care, provide the patient with backup ventilation prior to initiating the Pre-Use Test.



The Settings & Alarms Button

Press the **SETTINGS & ALARMS** button to modify Ventilation control settings and alarms for any of the three configured Ventilation therapy Presets. This button will open the Ventilation Presets configuration screen.

See *“Changing Ventilation Therapy Settings” on page 76* and *“Changing Alarm Settings” on page 105* for configuration instructions.



The Device Settings Button

Press the **DEVICE SETTINGS** button to modify VOCSN system controls such as alarm volume.

See *“Device Settings” on page 101* for more information.



The Logs Button

Press the **LOGS** button to view the Alarm Log and the Event Log. The VOCSN Logs screen is also accessible by tapping the alarm icon in the status bar.

See *“The Alarm Log” on page 115* and *“The Event Log” on page 116* for more information.



The Clinician Access Button

When the **Unlock Required?** device setting is set to **Yes**, pressing the **CLINICIAN ACCESS** button locks and unlocks VOCSN. See *“Clinician Access Mode” on page 99* for more information. Pressing the padlock button will prompt you to enter a Clinician Access Passcode to unlock the device and allow the configuration of all control settings.



Each VOCSN has a unique Clinician Access passcode. The passcode is the last four digits of the device serial number. This number is printed on the VOCSN back label. It is also visible from the Service section of the **MY VOCSN** screen.

When VOCSN is unlocked, pressing the unlocked padlock button will lock the device again. VOCSN will also automatically lock again after 15 minutes, regardless of user interaction with the device.

NOTE: Only controls set to “User and Clinician” in the Permissions screen will remain configurable when VOCSN is locked.

The Enable Prescribed Therapies Button

Press the **ENABLE PRESCRIBED THERAPIES** button to enable or disable VOCSN therapies such as the internal O2 Concentrator, Cough, Suction, Nebulizer, and/or the FiO2 Monitor.

VOCSN therapies are not configurable or usable (and will appear grayed out on the Therapy tab) unless enabled here. This feature allows clinicians to enable a suite of therapies appropriate for the patient condition, and disable any unnecessary therapies.

See *"Enabling and Disabling Prescribed Therapies"* on page 89 for more information.



NOTE: The Enable Prescribed Therapies menu button is only available when VOCSN is in Clinician Access mode. See *"Entering the Clinician Access Passcode"* on page 99 for instructions.

The Permissions Button

Press the **PERMISSIONS** button to set which controls are configurable when the device is locked. Controls set to "Clinician Only" will not be configurable until a Clinician Access Passcode is entered. Controls set to "User and Clinician" will be configurable at all times.

See *"Configuring Permissions"* on page 100 for more information.



NOTE: The Permissions menu button is only available when VOCSN is in Clinician Access mode. See *"Entering the Clinician Access Passcode"* on page 99 for instructions.

The My VOCSN Button

Press the **MY VOCSN** button in the menu for system information including the device configuration, serial number, and installed software version.



Controls and Settings

VOCSN controls are used to configure how the device behaves and delivers therapy. This chapter describes each of the VOCSN controls, lists the available settings, and provides configuration instructions.

After configuring a control, press **ACCEPT** to confirm and activate your selection. While modifying Ventilation and Cough settings, controls will operate normally at the last confirmed setting until you press the **ACCEPT** button to confirm the change.

WARNING: To ensure patient safety, check the Ventec One-Circuit and verify that all system settings and Presets are appropriate before providing therapy, and on a routine basis during therapy.

NOTE: If the VOCSN Permissions are configured for Clinician Only access to controls, those controls will be unavailable until entry of the Clinician Access password. See *"Clinician Access Mode"* on page 98 for more information.

NOTE: Control settings are not affected by system power interruption.

NOTE: V+Pro Emergency devices come with pre-configured initial settings to aid in rapid emergency response. These settings are present when using the device for the first time. Using the Reset Settings for New Patient control will reset all controls to the default settings described in this chapter (not those that came pre-installed on the unit.)

The sections that follow provide configuration instructions, and list the adjustable control settings available on VOCSN.

Ventilation Therapy Controls

VOCSN stores up to three pre-configured Ventilation therapy Presets. These Presets can be enabled and configured using the **SETTINGS & ALARMS** button on the Ventilation screen or Menu screen.

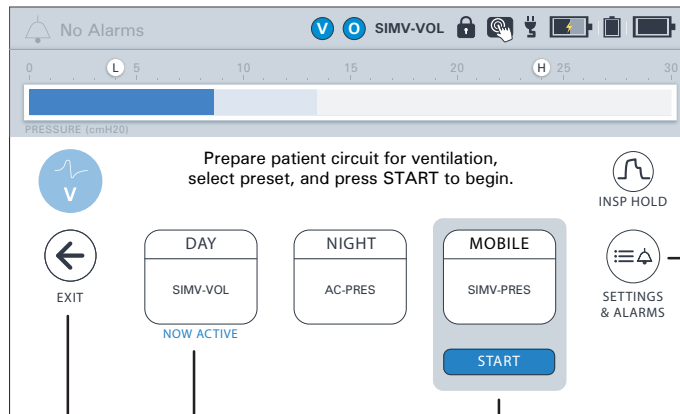

Press here if you need to change a control

Press here to EXIT this screen

This preset is providing therapy

To start using a new preset, select it and then press START

Changing Ventilation Therapy Settings

To configure the Ventilation therapy Presets:

- 1 Press the **Therapy** tab under the status bar, and then press the **VENTILATION** therapy button.
- 2 Press the **SETTINGS & ALARMS** button on the right side of the screen. The Ventilation therapy Preset configuration screen will appear. To modify any of the three Ventilation therapy Presets, select the relevant Preset name from the tabs at the top of the configuration screen.



NOTE: To enable a disabled Ventilation therapy Preset, press the Preset name, and then the **[Preset Name] Enable** control. Press **EDIT >**, and then select **Enabled**, and press **ACCEPT**.

- 3 Scroll through the list of available Ventilation controls, and press the name of the control requiring configuration. Press the **EDIT >** button on the right side of the screen.
- 4 Enter the new control setting using the numeric keypad, the slider bar, or the +/- buttons.
- 5 Press **ACCEPT** to activate your selection.
- 6 Follow the procedure above to modify additional controls. When configuration is complete, press the **< EXIT** tab.

NOTE: To configure VOCSN alarms, scroll past the ventilation controls until you see the **ALARMS** banner. Alarm controls are listed below the banner. See *"Changing Alarm Settings"* on page 105 for configuration instructions.

Available Ventilation Therapy Settings

The following table lists the configurable Ventilation therapy controls available on VOCSN. These controls are available separately for each of the three configurable Ventilation therapy Presets.

NOTE: Controls that cannot be edited will appear in gray. Controls may be locked because of the Permissions and Clinician Unlock feature. In addition, the Mode and Circuit Type controls will appear in gray and cannot be edited while the selected Ventilation Preset is running. These three controls can only be modified in an inactive Preset.

NOTE: The resolution of each control with numerical settings is 1, unless otherwise stated in the control description.

NOTE: **Black** text indicates the default setting.

Ventilator Control	Settings	Description
Apnea Rate	4 to 60 BPM Backup 12 BPM Backup	The Apnea Rate control sets the breath rate at which mandatory breaths will be delivered to the patient while the Apnea alarm is activated. NOTE: The Apnea Rate control is not available when Circuit Type is set to Mouthpiece.
Breath Rate	0 to 60 BPM 12 BPM	The Breath Rate control configures the minimum number of breaths per minute (BPM) delivered to the patient.

Ventilator Control	Settings	Description
Circuit Type	Active, Active with O ₂ , Passive, Passive with O ₂ , Mouthpiece, Valveless	Set the Circuit Type control to correspond with the type of patient circuit used during Ventilation therapy. <div style="border: 1px solid #92d050; border-radius: 10px; padding: 10px; margin-top: 10px;"> NOTE: The Circuit Type control cannot be modified for the running Ventilation therapy Preset. To modify the Circuit Type control, select an inactive ventilation Preset, set the Circuit Type control (and all other relevant controls) as desired, and then activate the Preset. </div> <div style="border: 1px solid #92d050; border-radius: 10px; padding: 10px; margin-top: 10px;"> NOTE: For more information on setting VOCSN controls for Mouthpiece ventilation, see <i>"Setting VOCSN Controls for Mouthpiece Ventilation"</i> on page 87. </div> <div style="border: 1px solid #92d050; border-radius: 10px; padding: 10px; margin-top: 10px;"> NOTE: Circuit Type settings that include an O₂ tube are available only with VOCSN configurations that include an internal O₂ Concentrator. </div>
EPAP	Active circuit: 0 to 25 cmH ₂ O Passive circuit: 4 to 25 cmH ₂ O 5 cmH₂O	Expiratory Positive Airway Pressure. The set EPAP will determine the pressure maintained between breaths and during the expiratory phase of breaths when the Ventilation Mode is set to Bi-Level.
Flow	15 to 60 L/min when the Patient Type control is set to Adult 30 L/min 4 to 25 L/min when the Patient Type control is set to Pediatric	During High Flow therapy, the Flow control is used to set the rate of gas flow in L/min through a high flow nasal cannula or other interface. <div style="border: 1px solid #92d050; border-radius: 10px; padding: 10px; margin-top: 10px;"> NOTE: The Flow control is only available when the High Flow control is set to On. </div> <div style="border: 1px solid #92d050; border-radius: 10px; padding: 10px; margin-top: 10px; background-color: #f0f0f0;"> <p>PRECAUTION: VOCSN Nebulizer therapy is not recommended during High Flow therapy for pediatric patients receiving <11 L/min. At Flow settings of <11 L/min, the accuracy of the delivered flow may be affected by Nebulizer therapy.</p> <p>Because the minimum flow from VOCSN is 5 L/min during High Flow with software versions 5.00 and later, and Nebulizer therapy adds additional flow to the patient circuit (typically 6 L/min when used as directed), the minimum flow to the patient will be 11 L/min, and the displayed flow value may not accurately represent the actual flow delivered.</p> </div>

Ventilator Control	Settings	Description
Flow Cycle	10 to 90% 25%	<p>Spontaneous breaths will cycle at the set Flow Cycle percentage of peak inspiratory flow. Setting the Flow Cycle control to 90% will result in a shorter inspiratory time; setting the Flow Cycle control to 10% will result in a longer one.</p> <p>When PC Flow Termination is set to On, mandatory and assist pressure breaths will cycle at the set Inspiratory Time or the set Flow Cycle percentage of the peak inspiratory flow, whichever comes first.</p> <p>NOTE: The Flow Cycle control is adjustable in increments of 5%.</p>
Flow Trigger	Active or Passive circuit: 0.5 to 9.0 L/min, Off Mouthpiece circuit: 0.5 to 3.0 L/min 2.0 L/min	<p>The set Flow Trigger will determine the flow differential necessary to initiate patient-triggered assist and spontaneous breaths.</p> <p>NOTE: The Flow Trigger control is adjustable in increments of 0.5.</p>
High Flow (available on English configurations with Leak+ compatible hardware, and Japanese configurations)	On, Off	<p>High Flow therapy provides a continuous flow of gas through a high flow nasal cannula or other interface. Set this control to On to access the Flow control.</p> <p>The High Flow control is available on Leak+ compatible devices when the Mode control is set to SIMV-Pressure, SIMV-Volume, or Vol. Targeted-SIMV. Like the CPAP function in SIMV modes, during High Flow therapy there is no set Breath Rate and all breaths are spontaneous.</p> <p>NOTE: To ensure proper performance of the Pre-Use Test, set the Circuit Type control to Valveless before setting High Flow to On. (Software versions 5.00 and later will automatically set the Circuit Type to Valveless when enabling High Flow.)</p> <p>NOTE: Cough therapy and Oxygen Direct (Pulse Dose) therapy are disabled during High Flow therapy.</p> <p>NOTE: For more information about the availability of the VOCSN Leak+ feature (including High Flow therapy), see <i>"Leak+ Performance"</i> on page 13.</p>
High Pressure Delay	None, 1 Breath, 2 Breaths	<p>High Inspiratory Pressure Alarm Delay. When enabled (1 Breath or 2 Breaths), the auditory and visual indicators for the High Pressure alarm will not activate until after the set number of consecutive breaths have exceeded the High Pressure alarm setting.</p> <p>NOTE: The H indicator in the status bar will flash red, and VOCSN will limit the pressure of the Ventec One-Circuit every time the High Pressure alarm setting is exceeded, regardless of the High Pressure Delay setting.</p>

Ventilator Control	Settings	Description
Humidification	Humidifier, HME	<p>Set the Humidification control to correspond to the type of humidification used during Ventilation therapy.</p> <p>NOTE: Based on the set Patient Type and Humidification Type, VOCSN automatically adjusts delivered therapy to compensate for differences in the compliance and volume of the Ventec One-Circuit.</p> <p>NOTE: When used with active, passive, and valveless Ventec One-Circuits, VOCSN was designed for use with a humidifier or HME. If used with neither, set the Humidification control to HME.</p>
Insp Hold¹	Off, On	<p>Use the Insp Hold button on the Ventilation therapy screen to perform an inspiratory hold, and obtain information about Plateau Pressure, Static Compliance, and the breath's pressure waveform. These monitors will display on the screen during and after the maneuver. An inspiratory hold can be performed for up to six seconds during a mandatory or assist volume breath.</p> <p>For more information about the Plateau Pressure and Static Compliance monitors, see <i>"Ventilation Monitors"</i> on page 119.</p> <p>IMPORTANT NOTE: If an Inspiratory Hold maneuver is performed during Suction or Nebulizer therapy, the Plateau Pressure and Static Compliance monitor readings will be inaccurate.</p> <p>NOTE: The Insp Hold button is only available when the following VOCSN setup conditions are met:</p> <ul style="list-style-type: none"> • The Mode is AC-Volume or SIMV-Volume. • The Circuit Type is Active or Active with O₂. • The Patient Type is Adult.
Inspiratory Time	0.3 to 5.0 seconds 1.0 second	<p>The Inspiratory Time control configures the duration over which the set pressure or volume is delivered to the patient during the inspiratory phase of each mandatory or assist breath.</p> <p>NOTE: The resolution of the Inspiratory Time control is 0.1 seconds.</p>
IPAP	4 to 40 cmH ₂ O above ambient 10 cmH₂O above ambient	<p>Inspiratory Positive Airway Pressure. The set IPAP will determine the pressure delivered during the inspiratory phase of mandatory and spontaneous breaths when the Ventilation Mode is set to Bi-Level or Spontaneous.</p>

¹ The Inspiratory Hold feature is only available with software versions 4.09 and later.

Ventilator Control	Settings	Description
Leak Compensation	Off, On	<p>The Leak Compensation control is available for active circuits. When set to On, the Leak Compensation algorithm runs continuously in the background to calculate and compensate VOCSN triggering, monitors, and waveforms for leaks in an active Ventec One-Circuit.</p> <p>IMPORTANT NOTE: When used with an active Ventec One-Circuit, VOCSN does not compensate the delivered inspiratory volume for leaks during volume and volume targeted breaths. See <i>"Leak Compensation"</i> on page 216. for details.</p> <p>NOTE: The Leak Compensation control is always On when the Circuit Type control is set to Passive or Valveless. It is always Off when the Circuit Type control is set to Mouthpiece.</p>
Mode	Bi-Level, Spontaneous, Assist/Control-Pressure, SIMV-Pressure , Assist/Control-Volume, SIMV-Volume Vol. Targeted-PS Vol. Targeted-PC Vol. Targeted-SIMV	<p>The set ventilation Mode determines how breaths are delivered to the patient. See <i>"Breath Types and Therapy Modes"</i> on page 52 for a description of how breaths are delivered in each available mode.</p> <p>NOTE: The Mode control cannot be modified for the active Ventilation therapy Preset. To modify the Mode control, select an inactive ventilation Preset, set the Mode control (and all other relevant controls) as desired, and then activate the Preset.</p>
Patient Type	Adult , Pediatric	<p>Set the Patient Type control to correspond to the type of Ventec One-Circuit (adult or pediatric) used during Ventilation therapy.</p> <p>NOTE: Based on the set Patient Type and Humidification Type, VOCSN automatically adjusts delivered therapy to compensate for differences in the compliance and volume of the Ventec One-Circuit.</p> <p>NOTE: Because of the circuit diameter, set the Patient Type control to Pediatric whenever the Circuit Type control is set to Mouthpiece.</p>
PC Flow Termination	Off, On	<p>Pressure Control Flow Termination. When the PC Flow Termination Control is set to On, mandatory and assist pressure breaths will cycle if the set Flow Cycle percentage of the peak inspiratory flow is reached, if the set Inspiratory Time has not yet elapsed.</p>

Ventilator Control	Settings	Description
PEEP	Active circuit: 0 to 25 cmH ₂ O Passive or Valveless circuit: 4 to 25 cmH ₂ O 5 cmH₂O	Positive End-Expiratory Pressure. The set PEEP will determine the pressure maintained between breaths and during the expiratory phase of breaths. <div style="border: 1px solid black; border-radius: 10px; padding: 5px;">NOTE: When the Circuit Type control is set to Mouthpiece, the PEEP control is disabled.</div>
Preset [1, 2, 3] Enable	Disabled, Enabled Preset 1: Enabled Preset 2 and 3: Disabled	The Preset [1, 2, or 3] Enable control enables or disables the configuration and use of any of the three configurable Ventilation therapy Presets.
Preset [1, 2, 3] Label	Preset 1, Preset 2, Preset 3	Use the [Preset Name] Label control to rename any of the three configurable Ventilation therapy Presets. Each Preset can be renamed using up to 10 alphanumeric characters.
Pres. Adj. Rate	Slow, Fast	In Volume Targeted ventilation modes, the Pres. Adj. Rate control determines the rate of pressure adjustments made to achieve the set Tidal Volume. Setting the Pres. Adj. Rate control to Slow will increment breaths by up to ± 1 cmH ₂ O per breath. The fast setting will increment breaths by up to ± 3 cmH ₂ O per breath. For more information, see <i>"Volume Targeted Ventilation Overview" on page 60</i> .
Pres. Minimum	1 to [40-PEEP] cmH ₂ O 5 cmH₂O	In Volume Targeted ventilation modes, the Pres. Minimum setting determines the minimum pressure of all Volume Targeted breaths. For more information, see <i>"Volume Targeted Ventilation Overview" on page 60</i> . <div style="border: 1px solid black; border-radius: 10px; padding: 5px;">NOTE: The Pres. Minimum setting may cause VOCSN to deliver more volume than intended by the Tidal Volume setting. Ventec Life Systems recommends using the High Minute Volume alarm to detect this condition.</div>
Pressure Control	1 to [50-PEEP] cmH ₂ O above PEEP 10 cmH₂O above PEEP	The set Pressure Control will determine the pressure above PEEP delivered during mandatory and assist breaths when the Ventilation Mode is set to Assist/Control-Pressure or SIMV-Pressure.
Pressure Support	0 to [40-PEEP] cmH ₂ O above PEEP 10 cmH₂O above PEEP	The set Pressure Support will determine the pressure above PEEP delivered during the inspiratory phase of spontaneous breaths during SIMV ventilation modes.

Ventilator Control	Settings	Description
Rise Time	1 to 6 4	<p>The Rise Time setting adjusts the speed of pressure elevation for pressure breaths. Lower settings (such as 1) raise the pressure quickly. Higher settings (such as 6) will slow the rate of pressure elevation.</p> <p>A high Rise Time setting in conjunction with a low Inspiratory Time setting may result in a lower peak inspiratory setting than expected. Adjust the Rise Time control as needed to both maximize patient comfort, and ensure that the target peak inspiratory pressure is reached.</p>
Sigh	Off, On	<p>When the Sigh control is set to On, a volume mandatory or assist breath is delivered at 150% the set Tidal Volume every 100th mandatory or assist breath.</p> <p>NOTE: The Sigh control is only available in volume Ventilation Modes (Assist/Control-Volume and SIMV-Volume).</p>
Tidal Volume	50 to 1500 mL 500 mL	<p>The Tidal Volume control adjusts the volume delivered to the patient during the inspiratory phase of volume breaths, or of pressure breaths when in Volume Targeted ventilation modes.</p> <p>NOTE: The resolution of the Tidal Volume control is 5 mL.</p> <p>NOTE: When delivering a Tidal Volume between 250 and 300 mL, an adult or pediatric Ventec One-Circuit may be used. Tidal Volumes ≥ 250 mL are typically appropriate for an adult Ventec One-Circuit. Tidal Volumes ≤ 300 are typically appropriate for a pediatric Ventec One-Circuit. Follow your healthcare institution's protocol for Ventec One-Circuit use and Tidal Volume delivery.</p> <p>NOTE: PEEP settings of 3 cmH₂O or less may reduce the accuracy of Tidal Volumes of 50 to 70 mL. For the best VOCSN performance, set PEEP to 4 cmH₂O or greater when the set Tidal Volume is 50 to 70 mL.</p>
Time Cycle	0.3 to 3.0 seconds 1.5 seconds	<p>Spontaneous breaths will cycle if the set Time Cycle has elapsed without the set Flow Cycle causing a breath to cycle.</p> <p>NOTE: The resolution of the Time Cycle control is 0.1.</p>

Control Limiting

VOCSN restricts the availability of some control settings when the set value of another interdependent control creates a limit. For example, available PEEP and Pressure Control settings are interdependent and control limited. If the PEEP control is set to 25 cmH₂O, the available Pressure Control settings are automatically limited to 25 cmH₂O or less to prevent VOCSN from delivering a total maximum pressure exceeding 50 cmH₂O.

If a limit is reached during control configuration, VOCSN will display a message on the configuration screen, indicating which interdependent control is limiting available settings. To adjust the setting of a control beyond its control limit, the interdependent control setting must be changed first.

The table below lists controls that are interdependent and control-limited, and describes the reason for the limit

Controls	Control limited to ensure:
Breath Rate (including Apnea Rate) and Inspiratory Time	The maximum inspiratory time will not exceed 0.5, multiplied by 60, divided by the set Breath Rate (or Apnea Rate). This is to prevent inverse I:E ratios.
EPAP and IPAP	The set IPAP is greater than the set EPAP, and the total delivered pressure will not exceed 40 cmH ₂ O.
FiO ₂ and Pulse Dose	Only one oxygen delivery method is used at a time.
High Pressure alarm and Pressure Control or Pressure Support	The High Pressure alarm is not set less than 3 cmH ₂ O above the set Pressure Control or Pressure Support.
Mode and Circuit Type controls for the active Ventilation Preset	Controls are configured at intended settings before beginning therapy.
PEEP and Pressure Support	The total delivered pressure will not exceed 40 cmH ₂ O.
PEEP and Pressure Control	The total delivered pressure will not exceed 50 cmH ₂ O.
Pres. Minimum, PEEP, and High Pressure alarm	To ensure the minimum pressure of breaths is less than the maximum pressure of breaths during Volume Targeted ventilation.
Tidal Volume and Inspiratory Time	Volume breaths will not deliver a flow greater than 120 L/min, or less than 10 L/min.

Controls Available in Each Ventilation Mode

The table below lists the controls available for configuration depending on the set Ventilation Mode. Unavailable controls will not be visible when setting Ventilation therapy controls.

NOTE: Controls available regardless of the set Ventilation Mode are not listed in the following table.

Control	Bi-Level	Spontaneous	Assist/ Control- Pressure	SIMV- Pressure	Assist/ Control- Volume	SIMV- Volume	Vol, Targeted- PS	Vol-Targeted- PC	Vol. Targeted- SIMV	High Flow
Apnea Rate	Yes, when Circuit Type is set to Active, Passive, or Valveless	No	Yes, when Circuit Type is set to Active, Passive, or Valveless							No
Breath Rate	No	No	Yes, when Circuit Type is set to Active, Passive, or Valveless	Yes	Yes, when Circuit Type is set to Active, Passive, or Valveless	Yes	No	Yes, when Circuit Type is set to Active, Passive, or Valveless	Yes	No
EPAP	Yes	No	No	No	No	No	No	No	No	No
Flow	No	No	No	Yes, when High Flow is set to On	No	Yes, when High Flow is set to On	No	No	Yes, when High Flow is set to On	Yes
Flow Cycle	Yes	Yes	Yes, when PC Flow Termination is set to On	Yes	No	Yes	Yes	Yes, when PC Flow Termination is set to On	Yes	No

Control	Bi-Level	Spontaneous	Assist/ Control- Pressure	SIMV- Pressure	Assist/ Control- Volume	SIMV- Volume	Vol, Targeted- PS	Vol-Targeted- PC	Vol. Targeted- SIMV	High Flow
High Flow	No	No	No	Yes, if device has Leak+ hardware	No	Yes, if device has Leak+ hardware	No	No	Yes, if device has Leak+ hardware	Yes, if device has Leak+ hardware, or is a Japanese configuration
Insp Hold	No	No	No	No	Yes	Yes	No	No	No	No
Inspiratory Time	Yes	No	Yes	Yes	Yes	Yes	Yes	Yes	Yes	No
IPAP	Yes	Yes	No	No	No	No	No	No	No	No
Leak Compensation	Yes, when Circuit Type is set to Active NOTE: The Leak Compensation control is always On when the Circuit Type control is set to Passive or Valveless, and always Off when the Circuit Type control is set to Mouthpiece.									No
PC Flow Termination	No	No	Yes	Yes	No	No	No	Yes	Yes	No
PEEP	No	No	Yes, when Circuit Type is set to Active, Passive, or Valveless							No
Pres. Adj. Rate	No	No	No	No	No	No	Yes	Yes	Yes	No
Pres. Minimum	No	No	No	No	No	No	Yes	Yes	Yes	No

Control	Bi-Level	Spontaneous	Assist/ Control- Pressure	SIMV- Pressure	Assist/ Control- Volume	SIMV- Volume	Vol, Targeted- PS	Vol-Targeted- PC	Vol. Targeted- SIMV	High Flow
Pressure Control	No	No	Yes	Yes	No	No	No	No	No	No
Pressure Support	No	No	No	Yes	No	Yes	No	No	Yes	No
Rise Time	Yes	Yes	Yes	Yes	No	Yes	Yes	Yes	Yes	No
Sigh	No	No	No	No	Yes	Yes	No	No	No	No
Tidal Volume	No	No	No	No	Yes	Yes	Yes	Yes	Yes	No
Time Cycle	Yes	Yes	No	Yes	No	Yes	Yes	No	Yes	No

Setting VOCSN Controls for Mouthpiece Ventilation

Mouthpiece patient circuits are intended for use with patients at least 5 years of age, who can place their mouths on the circuit to initiate breaths on their own.

NOTE: Because of the circuit size, set the Patient Type control to Pediatric during mouthpiece ventilation, even when VOCSN is used with an adult patient. For more information on mouthpiece circuit configuration, see *"Mouthpiece Patient Circuit Setup"* on page 40.

Setting the Circuit Type control to Mouthpiece will limit the available VOCSN ventilation modes, controls, monitors, and alarms as follows:

- The ventilation Mode control is limited to Spontaneous, Assist/Control-Pressure, and Assist/Control Volume. In Assist/Control ventilation modes, only assist breaths will be provided to the patient.
- The Breath Rate, Apnea Rate, PEEP, and Leak Compensation controls are unavailable.
- The Flow Trigger control is limited to 1 to 3 L/min
- The Patient Circuit Disconnect, Low Minute Volume, and High Minute Volume alarms are unavailable.
- The Exhaled Tidal Volume, Minute Volume, and Leak monitors are unavailable.
- The Humidification control is unavailable, because humidification is not used with mouthpiece patient circuits.

NOTE: In some cases, setting the High Pressure or Apnea alarm and using the Breath Rate monitor may help ensure patient safety.

Setting VOCSN Controls for High Flow Therapy

High Flow therapy is intended for use with spontaneously breathing patients, and is most often delivered through a high flow nasal cannula.

NOTE: For more information on using High Flow therapy with a nasal cannula, see *"Using a High Flow Nasal Cannula"* on page 26.

The High Flow control is available in SIMV ventilation modes. Setting the High Flow control to On will limit the available VOCSN controls, so that only the Flow control is configurable, and only the Flow monitor displays a value. In addition, the available Ventilation therapy alarms will be limited to Patient Circuit Disconnect.

NOTE: To ensure proper performance of the Pre-Use Test, set the Circuit Type control to Valveless before setting High Flow to On.

Enabling and Disabling Prescribed Therapies

Depending on the environment of use for VOCSN and the configuration purchased, change relevant system options to disable or enable therapies appropriately for the patient condition. To use the FiO2 Monitor, provide Cough, Suction, or Nebulizer therapy, or to deliver Oxygen therapy from the internal O2 Concentrator, begin by changing the relevant system control to **Enabled**. These features cannot be configured or activated until they are enabled.

NOTE: VOCSN is customizable and may be purchased in various configurations of the five available integrated therapies. Your device may include the option to enable all five therapies, or just the therapies purchased or prescribed by the treating physician.

To enable or disable an available VOCSN therapy:

- 1 Press the **Menu** tab.
- 2 Press the **ENABLE PRESCRIBED THERAPIES** button.
- 3 Press the name of the applicable therapy.
- 4 Press **EDIT >** on the right side of the screen.
- 5 Select the new setting.
- 6 Press **ACCEPT** to activate your selection.
- 7 Follow the procedure above to modify additional controls. When configuration is complete, press the **< EXIT** tab.



The following controls and settings are available from the [ENABLE PRESCRIBED THERAPIES](#) Menu button.

NOTE: **Black** text indicates the default setting.

Therapy	Settings	Description
Cough	Disabled, Enabled	The Cough option enables or disables the configuration and use of Integrated Cough Assistive Therapy (ICAT).
Nebulizer	Disabled, Enabled	The Nebulizer option enables or disables the configuration and use of Nebulizer therapy.
O2 Concentrator	Disabled, Enabled	The O2 Concentrator option enables or disables the configuration and use of the VOCSN internal O2 Concentrator.
Suction	Disabled, Enabled	The Suction option enables or disables the configuration and use of Suction therapy.
FiO2 Monitor	Disabled, Enabled	The FiO2 Monitor option enables or disables the use of VOCSN internal FiO2 monitor. NOTE: The FiO2 monitor is active only when the Oxygen Delivery Mode control is set to FiO2. See " <i>Oxygen Controls</i> " on page 90 for more information.

Oxygen Controls

VOCSN can be configured to provide Oxygen therapy in either Pulse Dose or FiO2 mode. Oxygen may be delivered from the internal O2 Concentrator (using Pulse Dose mode only), or an external source of high-pressure oxygen. Oxygen may also be provided using the VOCSN low-pressure oxygen port. See "Oxygen Therapy Setup" on page 41 for oxygen source setup instructions.

NOTE: The flow of oxygen from a low-pressure source is controlled by the source, not by the VOCSN oxygen controls. Oxygen from a low-pressure oxygen source is additive, and can be used in conjunction with oxygen from the internal O2 concentrator or an external high-pressure source. See "Connecting External Low-Pressure Oxygen" on page 44 for more information.

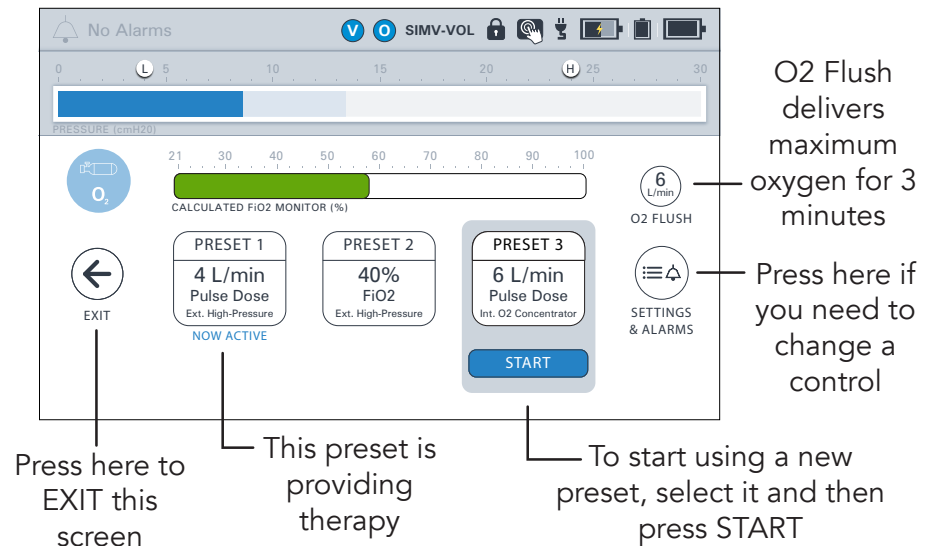

Changing Oxygen Settings

VOCSN stores up to three configured Oxygen therapy Presets. These Presets can be enabled and configured using the **SETTINGS & ALARMS** button on the Oxygen screen.

To change oxygen controls for any of the three Oxygen therapy Presets:

- 1 Press the **Therapy** tab, and then the **OXYGEN** button.
- 2 Select the Preset you want to modify, and then press the **SETTINGS & ALARMS** button on the right side of the screen. The Oxygen therapy Preset configuration screen will appear. You may select and configure any of the three Oxygen therapy Presets.

NOTE: To enable a disabled Oxygen therapy Preset, press the applicable Preset tab at the top of the settings screen, and then the **[Preset Name] Enable** control. Press **EDIT >**, and then select **Enabled**, and press **ACCEPT**.

- 3 Select any of the available Oxygen controls. Press the **EDIT >** button on the right side of the screen.
- 4 Enter the new control setting by selecting it from the list, using the numeric keypad, the slider bar, or the +/- buttons.
- 5 Press **ACCEPT** to activate your selection.
- 6 Follow the procedure above to modify additional controls. When configuration is complete, press the **< EXIT** tab.

Available Oxygen Settings

The following Oxygen therapy settings are available on VOCSN devices with the oxygen option enabled. Controls listed in this section are ordered as they appear in the VOCSN user interface.

NOTE: The **O2 FLUSH** button may be used during Oxygen therapy to deliver either 100% FiO2, or 6 L/min O2 Flow Equivalent (depending on the selected O2 Delivery Mode) for 3 minutes.

NOTE: **Black** text indicates the default setting.

Oxygen Control	Settings	Description
Preset [1, 2, 3] Enable	Disabled, Enabled	The Preset [1, 2, or 3] Enable control enables or disables the configuration and use of any of or all of the three configurable Oxygen therapy Presets.
Preset [1, 2, 3] Label	[up to 10 alphanumeric characters]	Use the Preset [1, 2, or 3] Label control to rename any of the three configurable Oxygen Presets. Each Preset can be renamed using up to 10 alphanumeric characters.
Oxygen Source	Internal O2 Concentrator, External High-Pressure , Low Pressure O2	<p>The Oxygen Source control can be configured to provide oxygen to the patient from one of three sources.</p> <p>The internal O2 Concentrator is used to provide Pulse Dose Oxygen therapy only. If the Oxygen Source control is set to Internal O2 Concentrator, the Oxygen Delivery Mode control will be set to Pulse Dose.</p> <p>When the Oxygen Source control is set to External High Pressure, the Oxygen Delivery Mode control may be set to either FiO2 or Pulse Dose.</p> <p>The Low Pressure O2 setting is designed to be used when a low-pressure source of external oxygen is connected to VOCSN and is used as the sole source of oxygen delivered to the patient.</p>
Oxygen Delivery Mode	FiO2 , Pulse Dose, O2 Bleed In	<p>FiO2 Oxygen therapy is delivered as a continuous stream through the Ventec One-Circuit connection port from an external high-pressure oxygen source.</p> <p>Pulse dose Oxygen Direct therapy is delivered through a small, integrated O2 tube in the Ventec One-Circuit, connected to the O2 port on the right side of VOCSN.</p> <p>See the descriptions of the FiO2 and O2 Flow Equivalent oxygen controls in this table for more information.</p> <p>The O2 Bleed In setting is automatically displayed when Oxygen Source is set to Low Pressure O2 (see above).</p>

Oxygen Control	Settings	Description
FiO2 (continuous)	21 to 100%	<p>Fraction of Inspired Oxygen. The FiO2 control adjusts the percentage of oxygen delivered continuously through the Ventec One-Circuit during ventilation.</p> <p>NOTE: While the Oxygen Source control is set to Internal O2 Concentrator, the FiO2 control will be unavailable.</p> <p>NOTE: Whenever the FiO2 control is set above 21%, use the FiO2 monitor and set the High FiO2 and Low FiO2 alarms appropriately for the patient condition.</p>
O2 Flow Equivalent (pulse dose)	Off , 0.5 to 6.0 L/min	<p>Use the O2 Flow Equivalent control to deliver pulse dose Oxygen Direct therapy through a Ventec One-Circuit O2 tube. Set the O2 Flow Equivalent control as if using an oxygen concentrator to add a continuous stream of oxygen into a patient circuit. Based on the O2 Flow Equivalent setting, VOCSN will calculate and produce pulse doses of oxygen that mimic the oxygenation resulting from a continuous stream of oxygen in L/min STPD. For additional technical information about oxygen delivery using the O2 Flow Equivalent control, see <i>"The Oxygen Direct System"</i> on page 218.</p> <p>WARNING: The O2 Flow Equivalent control setting may not result in a flow that corresponds exactly to bleeding a continuous flow of oxygen into a ventilator. Set the O2 Flow Equivalent control appropriately for the patient condition and verify adequate oxygenation to ensure patient safety.</p> <p>NOTE: Calculated FiO2 will display while using the O2 Flow Equivalent control (pulse dose). This calculation is based on the current ventilation and oxygen settings. See <i>"Calculated FiO2 Monitor"</i> on page 124 for more information.</p> <p>NOTE: Pulse Dose Oxygen Direct therapy is intended to be titrated to meet patient needs. Ventec Life Systems recommends verifying adequate oxygenation during elevated patient activity when setting the O2 Flow Equivalent control.</p> <p>NOTE: While the O2 Flow Equivalent control is enabled, the FiO2 control, monitor, and alarms will be disabled.</p> <p>NOTE: The O2 Flow Equivalent control is adjustable in increments of 0.1 L/min.</p>

Cough Therapy Controls

VOCSN stores up to three pre-configured Integrated Cough Assistive Therapy (ICAT) Presets. These Presets can be enabled and configured using the **SETTINGS** button on the Cough screen.

Changing Cough Therapy Settings

To change Cough therapy Preset settings:

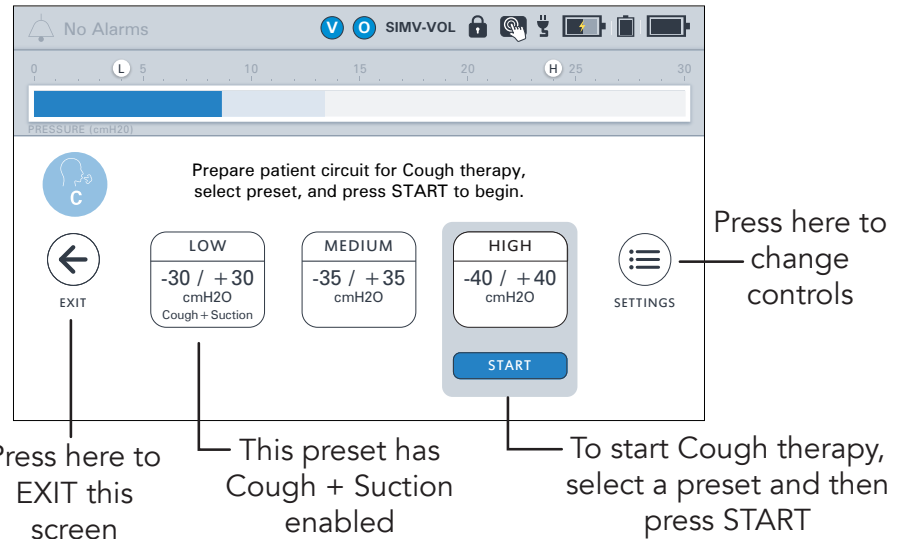

- 1 Press the **Therapy** tab, and then press the **COUGH** therapy button.
- 2 Press the **SETTINGS** button on the right side of the screen, and then press one of the three Preset tabs for the Cough therapy Preset requiring configuration

NOTE: To enable a disabled Cough therapy Preset, press the applicable Preset tab at the top of the settings screen, and then the **[Preset Name] Enable** control. Press **EDIT >**, and then select **Enabled**, and press **ACCEPT**.

- 3 Scroll to the applicable Cough control and press its name.
- 4 Press **EDIT >** on the right side of the screen.
- 5 Enter the new control setting.
- 6 Press **ACCEPT** to save your selection.
- 7 Press another Cough therapy control or Preset tab to change additional settings, following the procedure above, or press the **< EXIT** tab near the top of the screen when configuration is complete.

Available Cough Therapy Settings

The following table lists the configurable Cough therapy Preset controls available on VOCSN. These controls are available separately for each of the three configurable Cough therapy Presets.

NOTE: The resolution of each control with numerical settings is 1, unless otherwise stated in the description.

NOTE: **Black** text indicates the default setting.

Cough Control	Settings	Description
Breath Sync	Off, On	When the Breath Sync control is set to On, VOCSN will initiate a cough when patient effort is detected, regardless of the Pause Time setting.
Cough Cycles	1 to 10 3	The Cough Cycles control sets the number of coughs delivered by Touch Button Cough therapy each time it is activated.
Cough+Suction	Off , On	When the Cough+Suction control is set to On, VOCSN will automatically initiate Suction therapy during Cough therapy. Suction will begin at the start of the first Cough therapy insufflation, at the default set Suction setting, and run throughout the configured number of Cough Cycles plus an additional 2 minutes. To set the default Suction therapy setting for Cough+Suction, use the Set Default button on the Suction therapy screen. See <i>"Changing Suction Settings"</i> on page 5-23 for more information.
Exsufflation Pressure	-10 to -70 cmH2O -25 cmH2O	The Exsufflation Pressure control sets the delivered pressure during the exsufflation phase of Cough therapy. NOTE: If no Exsufflation Pressure is desired, you may instead set the Exsufflation Time to 0.0 seconds, and use the Pause Time setting to control the duration between cough insufflations.
Exsufflation Time	0.0 to 5.0 seconds 1.5 seconds	The Exsufflation Time control sets the duration over which the set Exsufflation Pressure is delivered. NOTE: The Exsufflation Time control is adjustable in increments of 0.1 seconds.
Insufflation Pressure	10 to 70 cmH2O 25 cmH2O	The Insufflation Pressure control sets the delivered pressure during the insufflation phase of Cough therapy.

Cough Control	Settings	Description
Insufflation Rise Time	1 to 6 4	The Insufflation Rise Time setting adjusts the duration over which VOCSN raises the pressure of the Ventec One-Circuit during cough insufflation. Lower settings raise the pressure quickly. Higher settings will slow the rate of pressure elevation.
Insufflation Time	0.0 to 5.0 seconds 1.5 seconds	The Insufflation Time control sets the duration over which the set Insufflation Pressure is delivered. NOTE: The Insufflation Time control is adjustable in increments of 0.1 seconds.
Pause Time	0.0 to 5.0 seconds 1.5 seconds	The Pause Time control sets the duration of the pause (at 0 cmH ₂ O) between each cough. Pause Time is the period after exsufflation and before the next insufflation. When the Breath Sync control is set to On, VOCSN will initiate a cough when patient effort is detected, regardless of the Pause Time setting. NOTE: The Pause Time control is adjustable in increments of 0.1 seconds.
Preset [1, 2, 3] Enable	Disabled, Enabled	The Preset [1, 2, or 3] Enable control enables or disables the configuration and use of any of or all of the three configurable Cough therapy Presets.
Preset [1, 2, 3] Label	[up to 10 alphanumeric characters]	Use the Preset [1, 2, or 3] Label control to rename any of the three configurable Cough Presets. Each Preset can be renamed using up to 10 alphanumeric characters.

Changing Suction Settings

The pressure of the vacuum used during Suction therapy is configurable. To modify the Suction vacuum control:

- 1** Click the **Therapy** tab, and then press the **Suction** button.
- 2** Press the **plus** and **minus** buttons on the right side of the screen to configure the vacuum intensity in mmHg.
- 3** To set the default Suction setting (the Vacuum setting when entering the Suction therapy screen and running Cough+Suction, if enabled), press the **SET DEFAULT** button when the Vacuum control is set to the desired level.
- 4** Press the **EXIT** button to return to the Therapy screen.

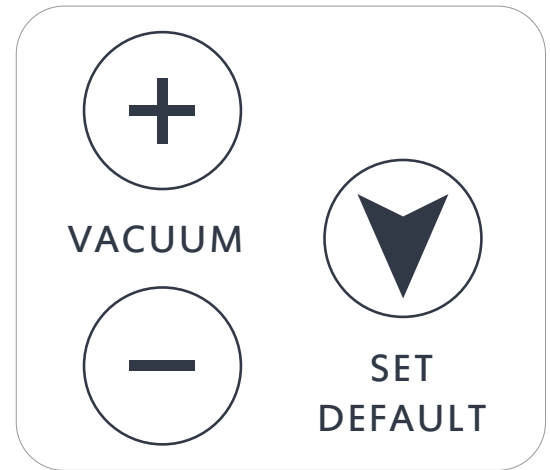

The following Suction therapy control is configurable.

NOTE: **Black** text indicates the default setting.

Suction Control	Settings	Description
Set Default	N/A	Pressing the Set Default button will configure the default Vacuum setting, which will appear when the Suction therapy screen is accessed, and run when the Cough+Suction feature is used.
Vacuum	-95 to -450 mmHg -180 mmHg	The Vacuum control sets the intensity of suction in mmHg. NOTE: The resolution of the Vacuum control is 5 mmHg.

Changing Nebulizer Settings

Nebulizer therapy can be configured to run from the VOCSN nebulizer drive, or to compensate for the flow added to the patient circuit from an external nebulizer. The Nebulizer Duration control may be set for a period of time between 5 and 60 minutes. To run Nebulizer therapy, first set the Nebulizer Duration control:

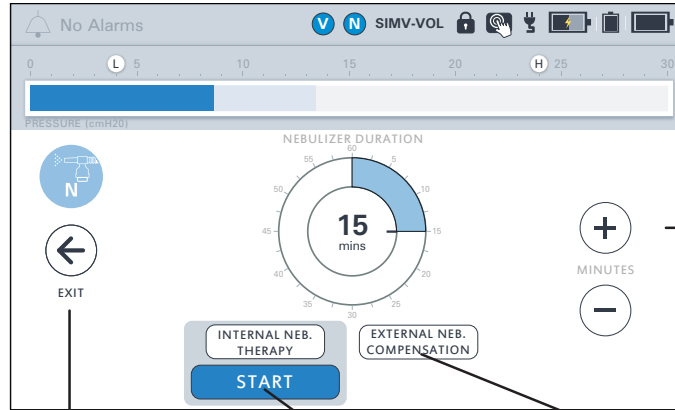

Press here to increase or decrease how long the nebulizer runs

Press here to EXIT this screen

Press here to start internal Nebulizer therapy

Press here to select external nebulizer compensation

- 1 Press the **Therapy** tab, and then press the **NEBULIZER** button.
- 2 Press the plus (+) and minus (-) buttons on the right side of the screen to configure the Nebulizer Duration.
- 3 Before starting therapy, select **Internal Neb. Therapy** to provide therapy from the VOCSN nebulizer drive, or **External Neb. Compensation** to compensate for the flow from an external nebulizer. See *"Starting Nebulizer therapy"* on page 9-13 for more information. While Nebulizer therapy is running, you may use the plus (+) button to add more time if needed.
- 4 Press the **EXIT** button to return to the main menu. The next time you access the Nebulizer therapy screen, the Nebulizer Duration setting will remain at whatever it was last set to.

NOTE: Every 10 minutes, internal Nebulizer therapy will pause for 6 seconds, and then automatically resume.

The following Nebulizer therapy control is available on VOCSN.

NOTE: **Black** text indicates the default setting.

Nebulizer Control	Settings	Description
Nebulizer Duration	5 to 60 minutes	The Nebulizer Duration control sets the duration over which VOCSN drives a connected nebulizer, or compensates for the flow from an external one.
	6 minutes	The resolution of the Nebulizer Duration control is 1 minute.

Clinician Access Mode

When the **Unlock Required?** device setting is set to **Yes**, pressing the **CLINICIAN ACCESS** button locks and unlocks VOCSN. Using the Permissions feature, VOCSN can be configured to restrict which controls are configurable by all users, and which control settings can only be changed by first entering a Clinician Access Passcode to unlock VOCSN.

When VOCSN is unlocked, all therapies and device settings are configurable. Unlocking VOCSN using the Clinician Access Passcode also allows access to the Permissions feature, where each control can be set to allow only clinician access (by first using the passcode), or set to allow configuration by all users at all times. See *"Configuring Permissions" on page 99* for more information.

Once the Clinician Access Passcode is entered, VOCSN will remain unlocked for 15 minutes. VOCSN will automatically lock again after 15 minutes, regardless of user interaction with the device. VOCSN can also be locked again at any time by pressing the Clinician Access button in the Menu tab.



Entering the Clinician Access Passcode

To enter the Clinician Access Passcode and unlock VOCSN:

- 1 Press the **Menu** tab.
- 2 Press the **CLINICIAN ACCESS** button.
- 3 Enter the four-digit Clinician Access Passcode. The Clinician Access Passcode is the last four digits of the device serial number. This number is printed on the VOCSN back label, and is also visible from the MY VOCSN screen.
- 4 Press **OK**. VOCSN will unlock, allowing the configuration of all therapy controls, permissions, and device settings.

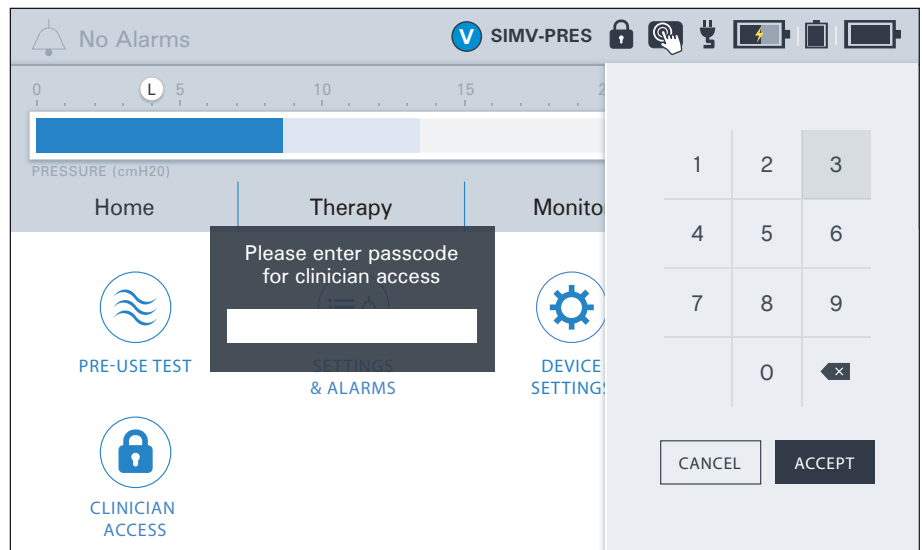

NOTE: When the **Unlock Required?** device setting is set to **Yes**, VOCSN will automatically lock after 15 minutes. To lock VOCSN manually, press the **CLINICIAN ACCESS** button on the Menu screen.

Configuring Permissions

The Permissions feature allows clinicians to configure which VOCSN controls are locked (cannot be changed) until the device is unlocked using the Clinician Access Passcode.

Control permissions set to User and Clinician are configurable at all times; they can be changed by anyone interacting with VOCSN. When a control permission is set to Clinician Only, the control will remain locked until the Clinician Access Passcode is entered.

NOTE: Locked control settings will display in the configuration screen in gray.

To change control permissions:



- 1** If not already unlocked, enter the Clinician Access mode by following the procedure in *"Entering the Clinician Access Passcode"* on page 98.
- 2** Press the **PERMISSIONS** button on the **Menu** screen.
- 3** Select the appropriate tab and scroll to the control you want to lock or unlock. Slide the toggle to switch between **User and Clinician** and **Clinician Only** access to the selected control.
- 4** When Permissions configuration is complete, press the **< EXIT** tab near the top of the screen.

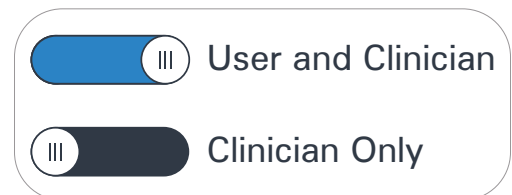

Device Settings

VOCSN device settings are modifiable, and include controls such as Alarm Volume, whether Clinician Access mode is enabled on the device, and the displayed date and time.

Changing Device Settings

To change a device setting:

- 1 Press the **Menu** tab.
- 2 Press the **DEVICE SETTINGS** button.
- 3 Scroll to the applicable device setting and press its name.
- 4 Press **EDIT >** on the right side of the screen.
- 5 Enter the new control setting.
- 6 Press **ACCEPT** to save your selection.
- 7 Follow the procedure above to modify additional controls. When configuration is complete, press the **< EXIT** tab.



Available Device Settings

The following table lists the configurable device settings available on VOCSN.

NOTE: If the internal battery depletes fully, VOCSN Date and Time settings will reset to their default values. To ensure the Alarm and Event logs record information accurately, verify the VOCSN Date and Time settings before use, and set them to the correct values if necessary.

NOTE: **Black** text indicates the default setting.

System Control	Settings	Description
Activate Battery Storage Mode	N/A	With software versions 4.11R and later, use the Activate Battery Storage Mode to place the fully charged internal battery and both removable, rechargeable batteries into a power-saving storage mode. This will preserve the battery charge and allow VOCSN to remain in storage for 12 months between recharge intervals. See <i>"Battery Storage Mode"</i> on page 170 for instructions and more information.
Alarm Volume	Low, Medium, High	The Alarm Volume control sets the loudness of auditory alarm indicators. WARNING: Set the Alarm Volume loud enough to be heard over expected ambient noise (such as a vacuum cleaner). Failure to hear and respond to an alarm condition may result in patient harm or death.
Calibrate Touchscreen	N/A	Use the Calibrate Touchscreen control to recalibrate the VOCSN touchscreen. Perform a touchscreen recalibration if VOCSN controls become difficult to select. After confirming the touchscreen recalibration and turning off the device, you will be asked to touch several areas on the screen when VOCSN restarts. NOTE: VOCSN must be powered off and restarted to complete this procedure.
Unlock Required?	No , Yes	Set the Unlock Required? control to Yes to require the use of a configuration password to access VOCSN controls. Using the Permissions feature, you can configure which controls cannot be modified without first entering the Clinician Unlock password. See <i>"Clinician Access Mode"</i> on page 98 for more information. Whenever VOCSN will be outside of the immediate control of a clinician, set the Clinician Unlock Required control to Yes to prevent the accidental activation of unintended therapies. NOTE: Depending on the optional features purchased for use with VOCSN, the default Clinician Unlock Required setting may be Yes.
Language	[Language name in target language]	Use the Language control to change the text displayed in the VOCSN operating system to a different language.
Date	N/A	The Date control sets the displayed date.
Reset Settings for New Patient	N/A	Selecting Reset Settings for New Patient will revert all VOCSN controls to their default settings, and also reset trending data exported for Multi-View reporting. See <i>"Multi-View"</i> on page 129 for more information. VOCSN will prompt you to confirm the reset before restoring factory default settings and resetting trend data.
Time	N/A	The Time control sets the displayed time.

VOCSN Therapy Interactions

The following table describes how starting Oxygen, Cough, Suction, or Nebulizer therapy affects any of the five other active VOCSN therapies:



 Running Therapy:		Effect of Starting Another Therapy:					
		Oxygen (Pulse Dose)	Oxygen (FiO2)	Oxygen (Ext. Low-Pressure) ²	Cough	Suction	Nebulizer ³
Ventilation	V	Therapies run simultaneously	Therapies run simultaneously	Therapies run simultaneously	Ventilation pauses, then automatically resumes	Therapies run simultaneously	Therapies run simultaneously
Oxygen (Pulse Dose)	O	N/A	Pulse Dose ends	Therapies run simultaneously	O2 pauses, then automatically resumes	O2 pauses, then automatically resumes	O2 pauses, then automatically resumes
Oxygen (FiO2)	O	FiO2 ends	N/A	Therapies run simultaneously	Therapies run simultaneously	O2 pauses, then automatically resumes	O2 pauses, then automatically resumes
Oxygen (Ext. Low-Pressure)	Controlled by Oxygen Source	Therapies run simultaneously	Therapies run simultaneously	N/A	Therapies run simultaneously	Therapies run simultaneously	Therapies run simultaneously
Cough	C	N/A	N/A	Therapies run simultaneously	N/A	Therapies run simultaneously with Cough + Suction feature	N/A
Suction	S	Suction ends	Suction ends	Therapies run simultaneously	Therapies run simultaneously	N/A	Suction ends
Nebulizer ¹	N	Nebulizer ends	Nebulizer ends	Therapies run simultaneously	Nebulizer pauses, then automatically resumes	Nebulizer ends	N/A

2 Although only one Oxygen Source selection can be selected and activated at a time, external low-pressure oxygen is additive and can be bled in through VOCSN while other therapies (including oxygen) are running.

3 This table describes the effects of internal Nebulizer therapy. External Nebulizer Compensation does not cancel or pause any other active therapy. If you are using an external nebulizer, disconnect it and stop nebulizer compensation before starting Cough therapy to prevent nebulized material from reaching VOCSN.

Alarms

A VOCSN alarm will activate whenever the device detects a condition that requires clinician or caregiver attention. Alarms will generate an audible tone, and/or a blue, yellow, or red alert banner across the top of the VOCSN screen. VOCSN has three alarm priority categories:

Alarm Priority	Visual Indicator	Auditory Indicator	Clinician or Caregiver Response
High	Red banner 	10 tones every 3 seconds	Requires immediate clinician or caregiver response
Medium	Yellow banner 	3 tones every 7 seconds	Requires prompt clinician or caregiver response
Low	Blue banner 	No auditory indicator	Requires clinician or caregiver attention

NOTE: An Inop alarm will generate a consistent audible tone and cause the On/Off button to flash red. In case of VOCSN Inop alarm, immediately provide the patient with an alternate source of ventilation, and restart VOCSN.

Set the Alarm Volume control so that alarm conditions are audible over ambient noise at all times, and at any anticipated distance away from VOCSN the caregiver may travel. Ventec Life Systems recommends ensuring the Alarm Volume control is set appropriately by simulating these conditions and verifying the alarm can be heard. See *“Device Settings” on page 101* for Alarm Volume configuration instructions. Similarly, if you are using an optional remote alarm, ensure it is placed somewhere it can be heard at all times.

WARNING: In environments containing multiple VOCSN devices, or similar devices set with different alarm limits (such as an intensive care unit), alarm conditions may be confused with other alarm sources. Failure to respond to an alarm condition quickly may result in patient harm.

NOTE: Auditory alarm indicators may be delayed for more than 10 seconds depending on the ventilation therapy configuration and the Patient Circuit Disconnect alarm setting, or the High Pressure Delay control setting.

Alarm Silence Button

VOCSN will emit an audible series of tones whenever a high- or medium-priority alarm activates. Press the Alarm Silence button on the front of VOCSN to silence the active alarm tones for 60 seconds. Press the Alarm Silence button again (or wait 60 seconds) to reactivate the alarm tones.

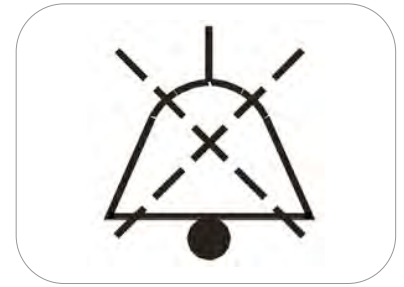

NOTE: The visual alarm (indicating the alarm condition and priority) will remain on the VOCSN screen.

NOTE: The Internal Battery Critically Low alarm cannot be silenced until VOCSN is plugged into an external source of power. To silence the alarm after plugging in VOCSN, access the Alarm Log (by pressing the alarm banner in the upper left-hand corner of the screen or pressing [LOGS](#) in the Menu tab), and then select [CLEAR LIST](#).

Changing Alarm Settings

WARNING: The VOCSN clinician is responsible for setting alarm limits appropriately for each patient condition. Do not set alarm limits to values that render the alarm system useless. Failure to set alarm limit values appropriately for the patient condition may result in patient harm.

To change ventilator alarm settings:

- 1 Press the [Menu](#) tab, or the [VENTILATION](#) button on the Therapy screen.
- 2 Press the [SETTINGS & ALARMS](#) button.
- 3 A Settings banner appears in the list first. Scroll down to the Alarms section.
- 4 Scroll to the applicable alarm and press its name.
- 5 Press [EDIT >](#) on the right side of the screen.
- 6 If the alarm has both low and high alarm limits, press the [L](#) icon to modify the low alarm limit, or the [H](#) icon to modify the high alarm limit. Enter the new alarm setting and press [ACCEPT](#) to save your selection.
- 7 Follow the procedure above to modify additional alarms. When configuration is complete, press the [< EXIT](#) tab.

Alarm Conditions and Settings

Possible alarm conditions and recommended actions are listed below. The following table also includes a description of each alarm and the range of alarm settings available. All possible alarm conditions are listed in alphabetical order.

NOTE: **Black** text indicates the default setting.

NOTE: Alarm settings are not affected by power interruption.

Alarm	Settings	Priority	Description	Recommended Action
Apnea	Off, 10 to 120 seconds 20 seconds	High	<p>The Apnea alarm activates when VOCSN has not delivered assist or spontaneous breaths (or coughs) for the set Apnea alarm duration. When this alarm activates, mandatory breaths will be delivered to the patient at the set Apnea Rate.</p> <p>The Apnea alarm will deactivate when the patient triggers two consecutive assist and/or spontaneous breaths.</p> <p>The Apnea alarm can also be deactivated by pressing the Clear List button twice from the Alarm Log screen. See <i>"Clearing an Alarm"</i> on page 116 for detailed instructions.</p> <p>NOTE: In SIMV ventilation modes, set the Apnea alarm to at least twice the configured breath period (60 seconds divided by the set Breath Rate) to avoid nuisance alarms.</p>	<p>Monitor the patient closely to ensure adequate ventilation therapy is delivered.</p> <p>Check to ensure patient-triggered breaths are not delivered less often than necessary, and adjust the Flow Trigger control setting if needed.</p>
Battery Use	N/A	Medium	<p>The Battery Use alarm activates whenever VOCSN switches from external power to battery power, or from any power source (including removable battery) to internal battery power.</p> <p>The Battery Use alarm remains active until it is reset by clearing the Alarm Log, or external power is connected to VOCSN.</p>	<p>Monitor battery charge status, and connect an external source of power when available.</p>
Check O2 Source	On, Off	Medium	<p>The Check O2 Source alarm activates when a connected source of external low-pressure oxygen is used and the monitored FiO2 falls below 24%.</p> <p>Use the Check O2 Source alarm to detect oxygen source disconnects when the Oxygen Source control is set to Low Pressure O2 and High Flow therapy is Off.</p>	<p>Monitor the patient closely to ensure adequate Oxygen therapy is delivered.</p> <p>Verify the connected low-pressure oxygen source is on and is functioning correctly.</p>

Alarm	Settings	Priority	Description	Recommended Action												
Check Patient Circuit	N/A	High	<p>The Check Patient Circuit alarm activates when VOCSN detects an inadequate leak in a passive or valveless circuit (see the chart below), or an error in the flow sensor of an active circuit.</p> <div data-bbox="209 527 1133 1031" data-label="Figure"> <table border="1"> <caption>Check Patient Circuit Alarm Leak Threshold Data</caption> <thead> <tr> <th>MAP (cmH2O)</th> <th>Leak (L/min)</th> </tr> </thead> <tbody> <tr><td>0</td><td>0</td></tr> <tr><td>5</td><td>8</td></tr> <tr><td>10</td><td>12</td></tr> <tr><td>15</td><td>15</td></tr> <tr><td>20</td><td>18</td></tr> </tbody> </table> </div>	MAP (cmH2O)	Leak (L/min)	0	0	5	8	10	12	15	15	20	18	<p>Check the Ventec One-Circuit to ensure the flow sensor tubing is connected to the Active exhalation valve connection port in VOCSN (for active circuits) or that the passive exhalation valve is unobstructed (for passive circuits).</p> <p>Run a Pre-Use Test.</p> <p>Monitor the patient closely to ensure adequate Ventilation and Oxygen therapy is delivered.</p> <p>If the problem persists, connect the patient to an alternate source of ventilation and contact your local Ventec Life Systems representative for service.</p>
MAP (cmH2O)	Leak (L/min)															
0	0															
5	8															
10	12															
15	15															
20	18															
Device Expired - Maximum Hours (V+Pro Emergency Configuration Only)	N/A	Low	<p>The Device Expired - Maximum Hours alarm activates on V+Pro Emergency configurations only when the Sys. PM Due In monitor is at or below 0. This alarm can be reset for up to 32 hours by clearing the alarm. (Software versions 4.13 and earlier will reset the alarm for 8 hours.)</p>	<p>Dispose of the device in accordance with local regulations. See <i>"Environmental Considerations"</i> on page 173 for more information.</p>												
High Breath Rate	Off , 10 to 99 BPM	Medium	<p>The High Breath Rate alarm will activate when the monitored breath rate is higher than the set High Breath Rate alarm limit.</p>	<p>Monitor the patient closely to ensure adequate ventilation therapy is delivered.</p>												

Alarm	Settings	Priority	Description	Recommended Action
High FiO2	Off , 24 to 99%	Medium	<p>The High FiO2 alarm activates when the monitored FiO2 percentage is higher than the set High FiO2 alarm limit.</p> <p>Set the High FiO2 alarm appropriately for the patient condition whenever the FiO2 control is set above 21%, or when using Low Pressure O2 with High Flow therapy.</p> <p>NOTE: If the FiO2 monitor is inactive, the High FiO2 alarm will be disabled. See <i>"FiO2 Monitor"</i> on page 123 for more information.</p> <p>NOTE: While using Low Pressure O2, the FiO2 monitor and alarms are available during High Flow therapy only. Deactivating High Flow therapy while using Low Pressure O2 will also deactivate the FiO2 monitor and alarms.</p>	<p>Monitor the patient closely.</p> <p>If the problem persists, contact your local Ventec Life Systems representative for service.</p>
High Minute Volume	Off , 1 to 59 L	Medium	<p>The High Minute Volume alarm activates when the monitored Minute Volume is larger than the set High Minute Volume alarm limit.</p> <p>NOTE: The High Minute Volume alarm will not activate when the Circuit Type control is set to Mouthpiece.</p>	<p>Monitor the patient closely.</p> <p>If the monitored Breath Rate is high, check to ensure patient-triggered breaths are not delivered more often than necessary, and adjust the Flow Trigger control setting if needed.</p> <p>If you are using an active Ventec One-Circuit and humidifier, clear any condensation from the active exhalation valve.</p>
High PEEP (High EPAP in Bi-Level Mode)	Off, 3 to 20 cmH2O above set PEEP 5 cmH2O	Medium	<p>The High PEEP alarm activates when the monitored PEEP is greater than PEEP plus the set High PEEP alarm limit.</p>	<p>Monitor the patient closely.</p> <p>Check for breath auto-cycling or breath stacking.</p> <p>If the problem persists, replace the Ventec One-Circuit.</p>

Alarm	Settings	Priority	Description	Recommended Action
High Pressure	10 to 80 cmH ₂ O 20 cmH₂O	High	<p>The High Pressure alarm activates when the monitored Airway Pressure exceeds the set High Pressure alarm limit for more than the number of consecutive breaths set with the High Pressure Delay control.</p> <p>When used with High Flow therapy, set the alarm above the normal operating pressure to detect circuit occlusions.</p> <p>NOTE: VOCSN will limit the pressure of breaths to the High Pressure alarm setting, and the (H) indicator will flash red every time the High Pressure alarm setting is exceeded, regardless of the High Pressure Delay setting.</p>	<p>Monitor the patient closely and check for reduced patient lung compliance during volume ventilation.</p> <p>Check the Ventec One-Circuit for occlusions.</p>
Inop	N/A	[Technical Alarm]	<p>The Inop alarm activates when VOCSN experiences a loss of power without available battery backup power, when the battery depletes and is the only available source of power, or when a software or hardware failure renders VOCSN unable to safely deliver therapy and/or monitor the patient.</p>	<p>Immediately provide the patient with an alternate source of ventilation.</p> <p>Press the On/Off button again to restart VOCSN. If the device remains inoperative, contact your local Ventec Life Systems representative for service.</p>
Internal Battery Critically Low	N/A	High	<p>The Internal Battery Critically low alarm activates when the internal battery is disconnected, faulty, or when the battery is critically low (charged to less than 33% its capacity).</p> <p>NOTE: The Internal Battery Critically Low alarm condition cannot be cleared or silenced until VOCSN is connected to external power. Connect external power and press the Clear List button twice from the Alarm Log screen to silence and clear the alarm.</p>	<p>Immediately connect VOCSN to a continuous source of external power and verify the charge status indicator light on the front of VOCSN illuminates.</p> <p>Clear the alarm by selecting CLEAR LIST in the Alarm Log.</p> <p>If alarm persists after application of external power, provide the patient with an alternate source of ventilation therapy.</p>

Alarm	Settings	Priority	Description	Recommended Action
Internal Battery Low	N/A	Medium	<p>The Internal Battery Low alarm activates when VOCSN internal battery charge status falls below 50%.</p> <p>NOTE: The Internal Battery Low alarm may be silenced, but the condition cannot be cleared until VOCSN is connected to external power.</p> <p>NOTE: Because the battery capacity diminishes over time, this alarm may activate more quickly as the battery ages.</p>	<p>Promptly connect VOCSN to a continuous source of external power.</p> <p>Clear the alarm by selecting CLEAR LIST in the Alarm Log.</p> <p>If the alarm persists after several hours of external power connection, contact your local Ventec Life Systems representative for service.</p>
Low Breath Rate	Off, 4 to 80 BPM 5 BPM	Medium	<p>The Low Breath Rate alarm activates when the monitored Breath Rate is less than the set Low Breath Rate alarm limit.</p>	<p>Monitor the patient closely to ensure adequate Ventilation therapy is delivered.</p> <p>Check to ensure patient-triggered breaths are not delivered less often than necessary, and adjust the Flow Trigger control setting if needed.</p>
Low FiO2	Off , 19 to 92%	Medium	<p>The Low FiO2 alarm activates when the monitored FiO2 falls below the set Low FiO2 alarm limit.</p> <p>Set the Low FiO2 alarm appropriately for the patient condition whenever the FiO2 control is set above 21%, or when using Low Pressure O2 with High Flow therapy.</p> <p>NOTE: If the FiO2 monitor is inactive, the Low FiO2 alarm is disabled. See <i>"FiO2 Monitor"</i> on page 123 for more information.</p> <p>NOTE: While using Low Pressure O2, the FiO2 monitor and alarms are only available during High Flow therapy. Deactivating High Flow therapy while using Low Pressure O2 will also deactivate the FiO2 monitor and alarms.</p>	<p>Monitor the patient closely to ensure adequate Oxygen therapy is delivered.</p> <p>Verify the connected high-pressure oxygen source is on and is not depleted.</p>

Alarm	Settings	Priority	Description	Recommended Action
Low Flow	n/a	Medium	<p>The Low Flow alarm activates automatically during High Flow therapy when VOCSN detects that the internal ventilator flow is less than 50% of the target flow for more than five minutes.</p> <p>NOTE: The Low Flow alarm is present in software versions 5.00 and later only.</p>	<p>Monitor the patient closely to ensure adequate High Flow therapy is delivered.</p> <p>If the problem persists, connect the patient to an alternate source of High Flow therapy and contact your local Ventec Life Systems representative for service.</p>
Low Inspiratory Pressure	Off, 1 to 40 cmH ₂ O 10 cmH₂O	High	<p>The Low Inspiratory Pressure alarm activates when the monitored Peak Inspiratory Pressure falls below the set Low Inspiratory Pressure alarm limit.</p> <p>NOTE: Ventec Life Systems recommends using the Low Inspiratory Pressure and Low Minute Volume alarms to detect hypoventilation.</p>	<p>Check the Ventec One-Circuit for leaks or disconnection.</p> <p>Monitor the patient closely to ensure adequate ventilation therapy is delivered.</p> <p>If the problem persists, connect the patient to an alternate source of ventilation and contact your local Ventec Life Systems representative for service.</p>
Low Minute Volume	Off, 0.1 to 9.9 L, 10 to 50 L 2.5 L	High	<p>The Low Minute Volume alarm activates when the monitored Minute Volume falls below the set Low Minute Volume alarm limit.</p> <p>NOTE: Ventec Life Systems recommends using the Low Minute Volume and Low Inspiratory Pressure alarms to detect patient hypoventilation.</p> <p>WARNING: If the Low Minute Volume alarm cannot be set appropriately for the patient condition because of a connected speaking valve or other reason, use an alternate respiratory monitor such as an oximeter or cardio-respiratory monitor to detect hypoventilation.</p>	<p>Monitor the patient closely to ensure adequate ventilation therapy is delivered.</p> <p>Check the Ventec One-Circuit for leaks or disconnection.</p> <p>During pressure-control ventilation, check the patient for reduced lung compliance or airway occlusion.</p>

Alarm	Settings	Priority	Description	Recommended Action
Low PEEP (Low EPAP in Bi-Level Mode)	On, Off	Medium	The Low PEEP alarm activates when the monitored PEEP falls 5 cmH ₂ O below the set PEEP control for 3 consecutive breaths.	Check the Ventec One-Circuit for leaks. Monitor the patient closely. If the problem persists, replace the Ventec One-Circuit.
Maintenance Due	N/A	Low	The Maintenance Due alarm activates when the Sys. PM Due In monitor is at or below 0, indicating that VOCSN is due for maintenance. This alarm can be reset for up to 32 hours by clearing the alarm. (Software versions 4.13 and earlier will reset the alarm for 8 hours.)	Contact your local Ventec Life Systems representative for service.
O₂ Concentration	N/A	Medium	The O ₂ Concentration alarm activates after five minutes or more (depending on VOCSN configuration settings) when the internal O ₂ Concentrator produces less than 82% oxygen, or less than 80% of the target pulse dose volume. It will also activate if there is a fault with the internal oxygen sensor that measures gas created by the internal O ₂ Concentrator, or if the monitored oxygen tank pressure is less than 4 PSI when using an external source of high-pressure oxygen.	If using an external source of oxygen, check the high-pressure source for depletion. If using the internal O ₂ concentrator, check the patient circuit O ₂ tube to ensure it is fully connected and is not blocked. If the problem persists, contact your local Ventec Life Systems representative for service.
O₂ Tube Disconnect	N/A	Medium	The O ₂ Tube Disconnect alarm activates within 5 minutes of disconnecting the O ₂ tube from the O ₂ tube connection port, while pulse dose Oxygen Direct therapy is active.	Reconnect the O ₂ tube to the O ₂ tube connection port.

Alarm	Settings	Priority	Description	Recommended Action
<p>Patient Circuit Disconnect</p> <p>(see below for modified alarm settings during High Flow therapy)</p>	<p>Off, 1-15 breaths (leak up to 75 L/min), 1-15 breaths (leak 75 to 175 L/min) 2 breaths (leak 75 to 175 L/min)</p> <p>NOTE: If the sensitivity toggle is not available, the more sensitive setting (0-75) is always active</p>	High	<p>The Patient Circuit Disconnect alarm activates when VOCSN detects a large leak in an active, passive, or valveless Ventec One-Circuit.</p> <p>The toggle at the top of the control editing window can be used to turn the alarm on or off.</p> <p>Use the numeric keypad to set the alarm delay. The Patient Circuit Disconnect alarm will activate in one breath plus the set number of breath cycles. For example, when set to 3, the alarm will activate on the 4th disconnect breath.</p> <p>The SENSITIVITY toggle changes the threshold at which the Patient Circuit Disconnect alarm activates. The 0-75 setting is intended for use with small and medium leaks, to ensure the alarm is sensitive enough to detect disconnects and most decannulations. The 75-175 setting desensitizes the alarm to reduce nuisance alarms when used with large leaks around the patient interface.</p> <div style="border: 1px solid gray; padding: 5px; margin-top: 10px;"> <p>PRECAUTION: Always test the Patient Circuit Disconnect alarm before use to verify it detects disconnects and/or decannulations with the specific patient conditions, patient interface, and VOCSN settings.</p> </div>	<p>Check the Ventec One-Circuit for leaks or disconnection.</p> <p>Monitor the patient closely to ensure adequate Ventilation therapy is delivered.</p> <p>If the problem persists, connect the patient to an alternate source of ventilation and contact your local Ventec Life Systems representative for service.</p>

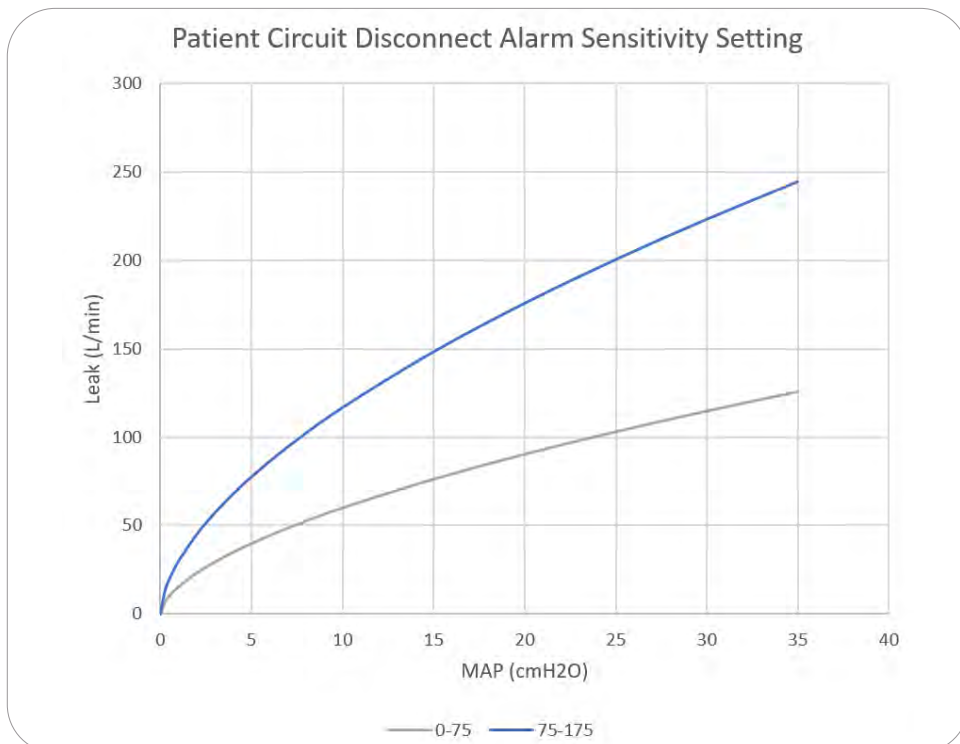

The graphic to the left shows how the **SENSITIVITY** setting interacts with leaks at various Mean Airway Pressures (MAPs):

NOTE: The Patient Circuit Disconnect alarm may not activate with every disconnect condition. Ventec Life Systems recommends using the Low Minute Volume, Low Inspiratory Pressure, and Apnea alarms in addition to the Patient Circuit Disconnect alarm to ensure Ventec One-Circuit disconnections are detected.

Alarm	Settings	Priority	Description	Recommended Action
Patient Circuit Disconnect (during High Flow therapy)	Off, Low Sensitivity, Medium Sensitivity , High Sensitivity	High	During High Flow therapy, the Patient Circuit Disconnect alarm will activate when no patient breathing is detected for 20 seconds. The Low Sensitivity setting is appropriate for use with smaller patients with smaller spontaneous breathing efforts. High Sensitivity makes the alarm more sensitive, and is appropriate for larger patients with larger spontaneous breathing efforts. <div style="border: 1px solid gray; padding: 5px; background-color: #f0f0f0;"> <p>PRECAUTION: During High Flow, the Patient Circuit Disconnect alarm may activate when the nasal cannula is connected to some patients (such as those with small spontaneous breathing efforts and using resistive nasal cannulas). In these instances, turn the Patient Circuit Disconnect alarm Off and provide continuous monitoring, such as pulse oximetry. Always test the Patient Circuit Disconnect alarm before use with High Flow therapy to verify it functions with the specific patient conditions, patient interface, and VOCSN settings.</p> </div>	Ensure the high flow nasal cannula (or other interface) is properly fitted to the patient. Monitor the patient closely. If the problem persists, connect the patient to an alternate source of ventilation and contact your local Ventec Life Systems representative for service.
Service Concentrator Soon	N/A	Low	The Service Concentrator Soon alarm activates when the VOCSN O2 Concentrator maintenance should be scheduled. This alarm can be reset for up to 32 hours by clearing the alarm. (Software versions 4.13 and earlier will reset the alarm for 8 hours.) The Service Concentrator Soon alarm remains active until the Internal O2 Concentrator is turned off.	Contact your local Ventec Life Systems representative for service.
System Fault (all conditions)	N/A	High	The System Fault alarm activates if VOCSN detects any one of multiple system fault conditions.	Use the Event Log to determine the System Fault number, and then see <i>"System Fault Detection Criteria and Recommended Action"</i> on page 223 and take the corresponding action.
Very Low FiO2	N/A	High	The Very Low FiO2 alarm activates when the monitored FiO2 is less than 18%. <div style="border: 1px solid gray; border-radius: 10px; padding: 5px; background-color: #fff9e6;"> <p>NOTE: If the FiO2 monitor is inactive, the Very Low FiO2 alarm will be disabled. See <i>"FiO2 Monitor"</i> on page 123 for more information.</p> </div>	Remove any gas source connected to VOCSN and monitor the patient.

The Alarm Log

The VOCSN Alarm Log lists all active alarms, and all other alarms activated since the last time the log was cleared.

To view the VOCSN Alarm Log at any time, press the alarm banner in the status bar, or:

- 1 Press the [Menu](#) tab.
- 2 Press the [LOGS](#) button.
- 3 If needed, press the [Alarms](#) tab.
- 4 Scroll down on the page to see additional alarms.



To clear the list of all but the active alarm conditions, press the [CLEAR LIST](#) button from the Alarm Log screen. Information about the alarm will also be stored in the VOCSN Event Log, which cannot be deleted.

The Mark Event Button

The Mark Event button appears in software versions 5.00 and later only. This button is accessible from the Alarm Log screen, or the Quick Access menu, and provides a means to create a marker in the device Event Log and Multi-View data.

When an interesting or noteworthy event occurs during therapy that you'd like to mark, press this button. A pin will appear in your Multi-View data at that moment of time, so that therapy information surrounding the event can be analyzed.



The Event Log

The Event Log stores the date and time of unit power on and off, alarm activation, the alarm name, and information about user interactions with the VOCSN alarm system and controls. The most recent 7,300 events, including alarms and changes to control settings will be accessible through the Event Log. As the VOCSN Event Log reaches capacity, the oldest Event Log records will be overwritten one at a time as new logs are created. Events in the Event Log cannot be deleted.

NOTE: The Event Log, including information about activated alarms, is retained through VOCSN shut down. The Event Log will be stored for at least 365 days after a total loss of device power.

To view the VOCSN Event Log:

- 1 Press the **Menu** tab.
- 2 Press the **LOGS** button
- 3 If needed, press the **Events** tab.
- 4 Scroll down on the page to see additional events. Press the forward and back page navigation buttons to see additional events.

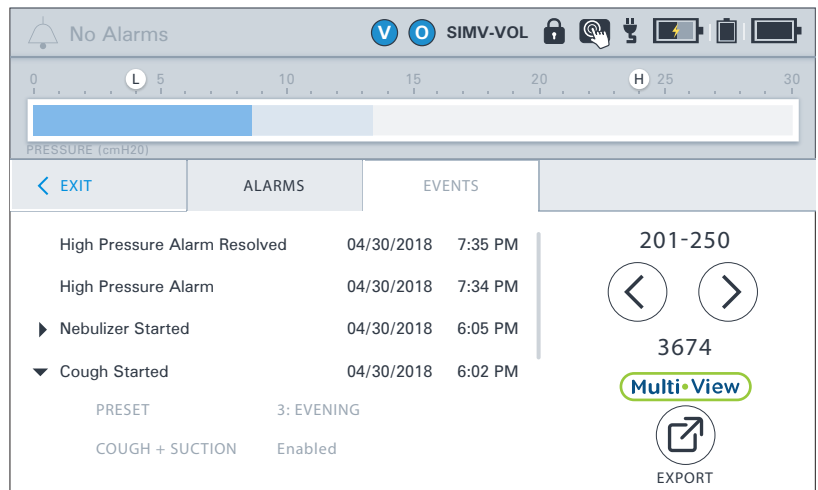

NOTE Timestamps on events in the VOCSN Event Log (and Alarm Log) are based on the configured VOCSN Date and Time setting at the time the event occurred. If the VOCSN Date and Time settings are incorrect, the timestamps shown in the log will also be incorrect, and cannot be corrected. However, VOCSN Multi-View timestamps are relative, and will recalculate based on the most recent VOCSN Date and Time setting when data is exported and a report is generated.

NOTE: For more information on VOCSN Multi-View trend reporting, see "Multi-View" on page 129 .



Clearing an Alarm

Visual indicators of an alarm condition remain on the screen as a count in the status bar and a list in the Alarm Log until the alarm condition is resolved and the list is cleared. To clear an activated alarm:

- 1 Press the Alarm Silence button on the front of VOCSN to silence the alarm tones, if desired.
- 2 Resolve the alarm condition by taking the appropriate action. When an alarm condition is resolved, the alarm will clear. A log of the alarm activation will be recorded in the Alarm Log and the Event Log.
- 3 Access the Alarm Log through the Menu tab, or by pressing the Alarm banner in the upper left corner of the VOCSN touchscreen, then select **CLEAR LIST** to remove all but active alarms from the Alarm Log.

NOTE: A record of recent alarm conditions will remain in the Event Log, even when the Alarm Log has been cleared.

- 4 Press the **< EXIT** tab to exit the Alarm Log.

Remote Alarms and Nurse Call Systems (Optional)

Connect an optional remote alarm or nurse call system using the port on the back of VOCSN. See *"Connecting a Nurse Call System or Remote Alarm"* on page 49 for setup information.

NOTE: The delay between an alarm condition and activation of the remote alarm port is <1 s. Refer to the remote alarm manufacturer's instructions for use to determine the maximum possible delay between VOCSN alarm and remote alarm activation.

Monitors

VOCSN monitors multiple parameters. View monitored VOCSN Ventilation therapy data by pressing the Monitors tab. Oxygen, Cough, Suction, and Nebulizer therapy monitors are available by navigating to the relevant therapy screen.

NOTE: Monitored data depends on the set Circuit Type, Mode, and the number of breaths delivered. Monitors will display "--" if they are not available for the set Circuit Type or Mode. VOCSN will display a spinning circle graphic while it is calculating a monitored value.

From the Monitors tab, press the **CUSTOMIZATION** button to configure which monitors display on the screen. The three monitors configured to display on the top row of the Monitors tab will appear on the Home screen.

Press the **WAVEFORMS** button to view real-time flow, volume, and pressure Ventilation therapy waveforms.

NOTE: When used with active, passive, and valveless Ventec One-Circuits, VOCSN was designed for use with a humidifier or HME. All volumes and flows are expressed in BTPS unless stated otherwise.

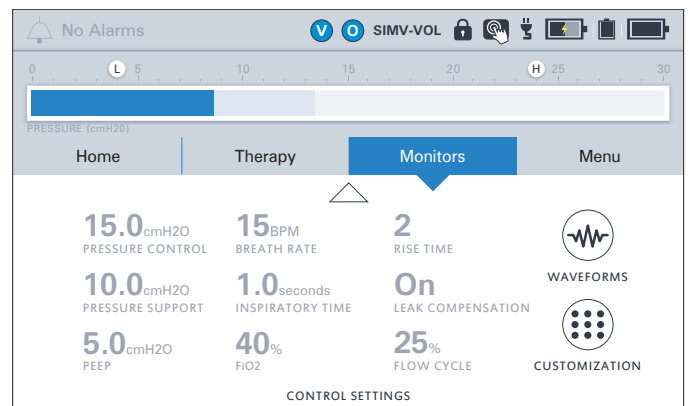
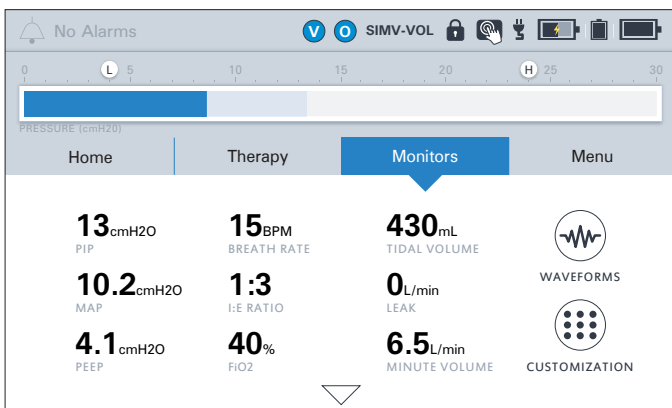

Ventilation Monitors

Monitored Ventilation therapy parameters and active control settings can be viewed using the Monitors tab on the VOCSN touchscreen. The displayed monitors and controls are customizable. To change which monitors and control settings display on the Monitors tab, see *"Monitor Screen Customization" on page 121*.

Press the down arrow at the bottom of the Monitors screen to view currently active Ventilation and Oxygen therapy control settings.

VOCSN will only display the monitors applicable to the delivered therapy. The table below lists these dependencies. For more information about the monitors available during mouthpiece ventilation, see *"Setting VOCSN Controls for Mouthpiece Ventilation" on page 88*.

VOCSN continuously monitors the following parameters during Ventilation therapy:

Monitor	Range	Description
Breath Rate	0 to 100 BPM	Breath Rate. Provides a calculation of the average number of breaths per minute (BPM) delivered to the patient based on the previous 8 breaths.
EPAP (Bi-Level ventilation modes only)	0 to 45 cmH2O	Expiratory Positive Airway Pressure. The EPAP monitor displays the pressure maintained between breaths (from the end of exhalation). NOTE: The EPAP monitor is only available when the Ventilation Mode is set to Bi-Level.
Estimated Vte (Passive and Valveless Ventec One-Circuits only)	0 to 2000 mL	Estimated Exhaled Tidal Volume. When Circuit Type is set to Passive or Valveless, VOCSN will calculate the estimated volume of the last patient exhalation. This monitor is based on internal VOCSN calculations, rather than a measurement. WARNING: The accuracy of Vte measurements may be affected by large leaks at the patient interface.
FiO2	15 to 95%, >95%	See <i>"Oxygen Therapy Monitors" on page 122</i> .
Flow Setting	4 to 60 L/min	During High Flow therapy, the Flow Setting monitor displays the Flow control setting.
Flow waveform	User Scalable	Real-time Ventilation therapy flow waveforms are visible by pressing the WAVEFORMS button from the Monitors tab. See <i>"Waveform Monitors" on page 120</i> for more information.

Monitor	Range	Description
I:E Ratio	9.9:1 to 1:9.9	The I:E Ratio monitor displays the average ratio between inspiratory and exhalation time over the last 8 breaths.
Leak	0 to 200 L/min	The Leak monitor displays the flow of gas leaking during each breath in L/min.
MAP	0 to 50 cmH ₂ O	Mean Airway Pressure. The MAP monitor displays the average pressure delivered throughout the breath period of the last eight breaths.
Minute Volume	0 to 60 L	The Minute Volume monitor displays the calculated volume of air delivered to the patient over one minute, based on the average breath rate and V _{te} (for active circuits) or Estimated V _{te} (for passive and valveless circuits) of the last eight breaths.
Patient Effort	N/A	<p>The patient effort icon appears on the left side of the airway pressure manometer in the status bar when VOCSN delivers a patient-triggered breath.</p> <p>NOTE: Ventec Life Systems recommends periodically verifying that the Patient Effort indicator in the status bar appears in synchrony with actual patient effort to breathe.</p>
Patient Triggered	0 to 100%	The Patient Triggered monitor displays the percentage of the last 100 breaths that were initiated by the patient.
Peak Exh Flow	0 to 200 L/min	Peak Exhalation Flow. Measures the maximum expiratory flow during exhalation.
Peak Insp Flow	0 to 200 L/min	Peak Inspiratory Flow. Measures the maximum inspiratory flow during inhalation.
PEEP	0 to 45 cmH ₂ O	<p>Positive End Expiratory Pressure. The PEEP monitor displays the pressure maintained between breaths (from the end of exhalation).</p> <p>NOTE: During Bi-Level ventilation, the EPAP monitor is in use, instead.</p>
PIP	0 to 85 cmH ₂ O	Peak Inspiratory Pressure. The PIP monitor displays the maximum pressure delivered during the last breath.

Monitor	Range	Description
Plateau Pressure¹ (during Inspiratory Hold)	0 to 85 cmH ₂ O	The Plateau Pressure monitor measures the pressure of a breath during an Inspiratory Hold maneuver. It is displayed on the Inspiratory Hold screen after the maneuver is performed.
Pressure (during Ventilation therapy)	0 to 80 cmH ₂ O	Airway Pressure is monitored using a manometer in the status bar. The dark blue bar represents the pressure of the current breath. The light blue bar represents the peak pressure delivered during the previous breath.
Pressure waveform	User Scalable	Real-time pressure waveforms are visible by pressing the WAVEFORMS button from the Monitors screen. See <i>"Waveform Monitors"</i> on page 120 for more information.
Static Compliance¹ (during Inspiratory Hold)	<10, 10 to 100, >100 mL/cmH ₂ O	The Static Compliance monitor measures compliance during an Inspiratory Hold maneuver. It is displayed on the Inspiratory Hold screen after the maneuver is performed.
Volume waveform	User Scalable	Real-time Ventilation therapy volume waveforms are visible by pressing the WAVEFORMS button from the Monitors tab. See <i>"Waveform Monitors"</i> on page 120 for more information.
Vte (Active Ventec One-Circuits only)	0 to 2000 mL	Exhaled Tidal Volume. The volume of the last patient exhalation. When Leak Compensation is set to On, VOCSN compensates for leaks to monitor the volume of the last patient exhalation. WARNING: The accuracy of Vte measurements may be affected by large leaks at the patient interface.

Waveform Monitors

Press the **WAVEFORMS** button from the Monitors screen to access real-time, scalable Ventilation therapy waveforms. The screen displays any two of the following three available waveforms: pressure, flow, and volume.

To vertically scale the waveforms, click the up and down button next to the waveform. Use the left and right button to modify the time scale of the waveform. Use the pause button to stop the waveform at any time. When the play button is pressed, the waveforms will resume displaying real-time monitored waveform data. Press the waveform button again to switch between pressure, flow, and volume waveforms.



¹ The Inspiratory Hold feature (and associated Plateau Pressure and Static Compliance monitor) is only available with software versions 4.09 and later.

Monitor Screen Customization

Press the **CUSTOMIZATION** button from the Monitors tab to choose which monitors and control settings display on each page of the VOCSN Monitor screen. The first page shows a customizable set of nine monitors. The second page shows a customizable set of nine control, alarm, and oxygen settings.



NOTE: The monitors selected for the top row of the Monitors tab will display on both the Monitors and the Home tab.

To customize the Monitors screen:

- 1** Press the **CUSTOMIZATION** button on the Monitors tab, and then press the monitor (or control setting) you want to modify.
- 2** Press **EDIT >** on the right side of the screen.
- 3** Press the name of the monitor you want to appear in the highlighted screen location.
- 4** Press **ACCEPT** to confirm your selection.
- 5** Press another monitor and repeat the steps above to make additional changes, or press the **< EXIT** tab near the top of the screen to exit the customization screen.

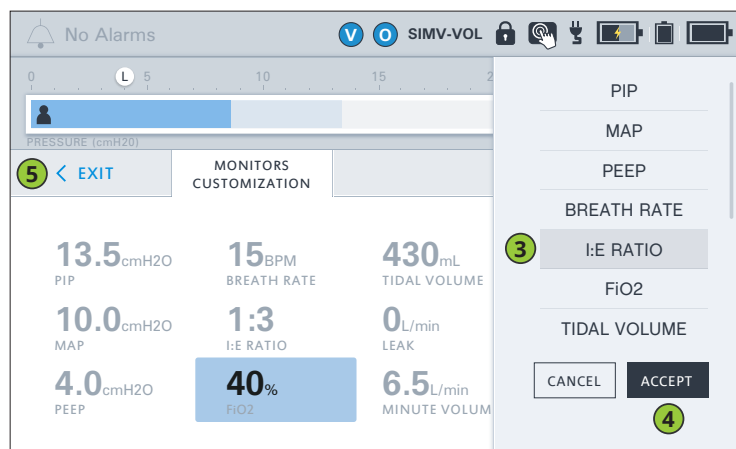
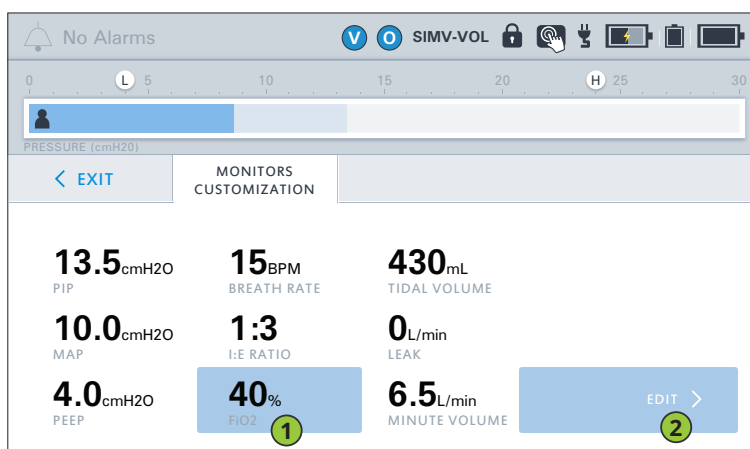

Oxygen Therapy Monitors

The FiO₂ and Calculated FiO₂ monitors provide information about the percentage of oxygen inhaled by the patient. Depending on the Oxygen Delivery Mode selected, either the FiO₂ or Calculated FiO₂ monitor will display on the Oxygen therapy screen as a green fill above the Presets.

FiO₂ Monitor

Fraction of inspired oxygen. The FiO₂ monitor measures the percentage of oxygen delivered in the inspiratory phase of each breath when using the FiO₂ control with an external source of high-pressure oxygen.²

If enabled and active, the FiO₂ monitor is visible from the Monitors tab, or from the Oxygen therapy screen when the FiO₂ control is set above 21%. Use the FiO₂ monitor to ensure the accuracy of delivered Oxygen therapy whenever the FiO₂ control is used.

To activate and use the FiO₂ monitor, it must be enabled (see *"Enabling and Disabling Prescribed Therapies"* on page 89), the Oxygen Delivery Mode control must be set to FiO₂ (see *"Oxygen Controls"* on page 91), and the FiO₂ control must be set above 21%. When the FiO₂ monitor is inactive, the High FiO₂, Low FiO₂, and Very Low FiO₂ alarms are also inactive.

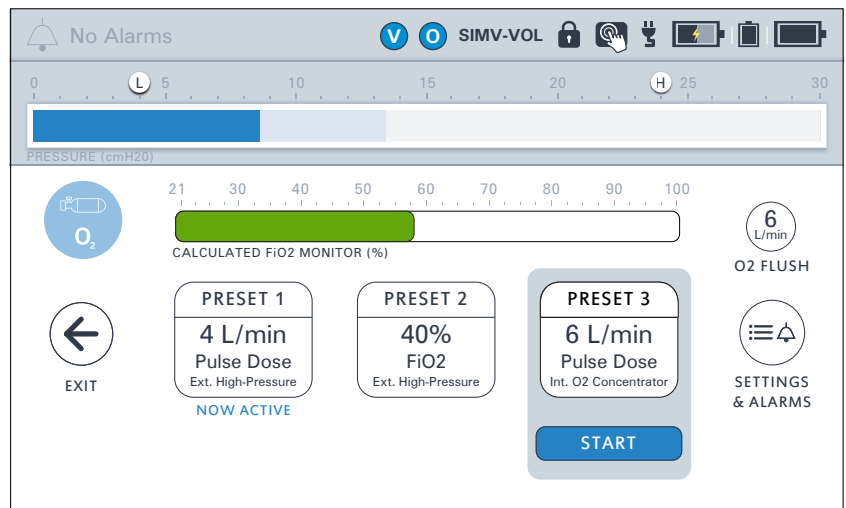

NOTE: For +Pro configurations, any additive low-pressure oxygen is also detected by the VOCSN FiO₂ monitor during Oxygen therapy, and will be added to the monitored value.

NOTE: The FiO₂ monitor requires time to warm up. During the first five minutes of use, the FiO₂ monitor will display "--" as the FiO₂ value. The FiO₂ monitor will also display dashes if the FiO₂ monitor is disabled, or the Oxygen Delivery Mode control is set to Pulse Dose.

NOTE: The FiO₂ monitor is equipped with automatic barometric pressure compensation.

NOTE: Performance of the FiO₂ monitor may be affected by high humidity, cyclical pressure, or other sources of interference.

² The FiO₂ monitor and alarms are also available when using low-pressure oxygen during High Flow therapy.

Calculated FiO2 Monitor

The Calculated FiO2 monitor displays when using the O2 Flow Equivalent control to provide pulse dose Oxygen Direct therapy. The Calculated FiO2 monitor is based on the Tidal Volume setting for volume breaths. For pressure breaths, the calculation is based on the average leak-compensated delivered volume of the last 8 breaths.

Because the Calculated FiO2 monitor is an average, it is important that the patient receive stable Ventilation therapy for at least 8 breaths before using the Calculated FiO2 monitor to make decisions about adjusting Oxygen Direct therapy. The monitor may fluctuate based on the number of mandatory, assist, or spontaneous breaths delivered over the last 8 breaths.

NOTE: The accuracy of the Calculated FiO2 monitor may be affected by large leaks in the patient circuit.

NOTE: The Calculated FiO2 monitor may fluctuate. These fluctuations are based on the type of breaths delivered (mandatory, assist, or spontaneous), and are consistent with changes in FiO2 delivered to patients using traditional oxygen delivery methods.

NOTE: O2 Flow Equivalent delivery is dependent on the patient's minute volume. Because oxygen delivery may be limited by minute volume, increasing the O2 Flow Equivalent control may not result in a corresponding increase to the Calculated FiO2 monitor.

Cough Therapy Monitors

Once Touch Button Cough therapy is initiated, the VOCSN touchscreen will display a Cough monitor screen. The Ventilation pressure manometer in the status bar will change to a Cough airway pressure manometer, which displays both positive and negative pressure readings.

If Breath Sync is On, the Flow Trigger setting will also display. If Cough+Suction is On, a Suction therapy duration monitor will appear in the upper right hand corner of the screen, to indicate the remaining duration of Suction therapy, which continues for 2 minutes after Cough therapy completes. Touch the Suction therapy duration monitor to access the Suction therapy screen, where the Vacuum control may be modified if necessary.

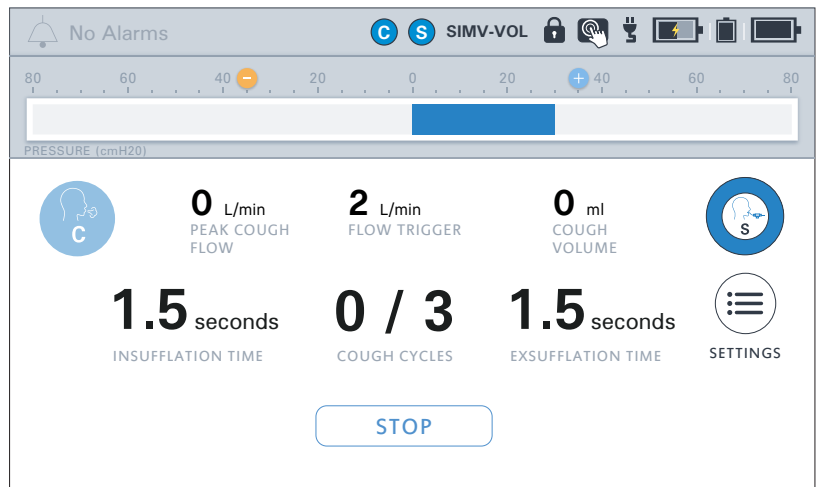

During Touch Button Cough therapy, VOCSN monitors and displays the following parameters:

Monitor	Range	Description
Cough Cycles	0 to 10	The Cough Cycles monitor displays the number of Cough Cycles delivered to the patient, as well as the total number of Cough Cycles configured.
Cough Volume	0 to 4000 mL	The Cough Volume monitor will display the volume of last cough delivered in mL.
Peak Cough Flow	0 to 350 L/min	The Peak Cough Flow monitor will display the maximum flow through the Ventec One-Circuit during the last cough in L/min.
Pressure (during Cough therapy)	-80 to 80 cmH2O	Airway Pressure during Cough therapy is monitored using a manometer in the status bar. The dark blue bar represents the positive (insufflation) pressure. The orange bar represents the negative (exsufflation) pressure.

Nebulizer Therapy Monitor

Once Nebulizer therapy is initiated, the Nebulizer screen will display a Nebulizer Minutes Remaining monitor. This monitor begins at the configured Nebulizer Duration and counts down until Nebulizer therapy is complete.

NOTE: The range of the Nebulizer Minutes Remaining monitor is 0 to 60 minutes.

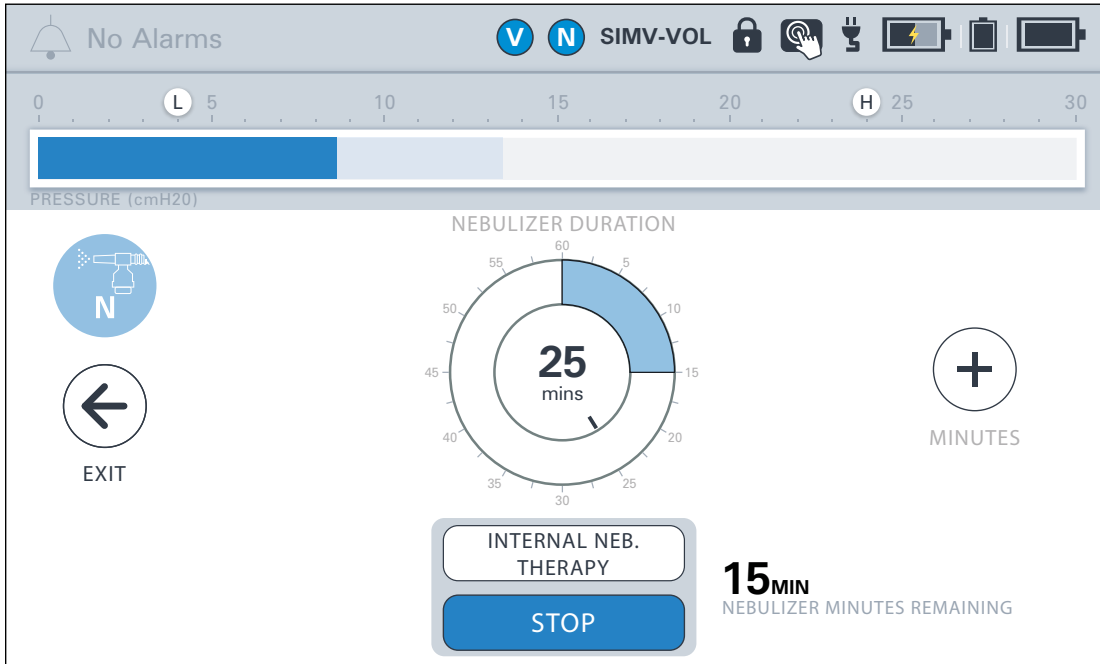

System Monitors

VOCSN monitors the following system parameters. To view these monitors, press the [MY VOCSN](#) button from the Menu tab.

Monitor	Range	Description
Date	2016-01-01 to 2030-12-31	The Date monitor displays the configured date. Periodically check that the date setting is correct. To update the set Date setting, see <i>"Changing Device Settings" on page 101</i> .
Sys. PM Due In	-99,999 to 10,000 hours	The Sys. PM Due In monitor displays the time remaining in hours until the next preventative maintenance activities should be performed. A negative number indicates how many hours the maintenance is past due. Resetting this monitor requires service-level access to the system. Contact your local Ventec Life Systems representative for service.
Media Bed Status	Internal O2 Concentrator Off - Service	The Media Bed Status monitor displays the current state of the media bed. Media Bed Status monitors include "Internal O2 Concentrator Off": O2 Internal Concentrator therapy not active, "Warming Up": O2 Internal Concentrator therapy started, "Good": O2 Internal Concentrator therapy active and media bed healthy, "Plan Service": O2 Internal Concentrator therapy active and Service Concentrator soon alarm active and "Service": O2 Internal Concentrator therapy active and O2 Concentrator alarm active.
VPSA PH4	400 - 700 RPM	The VPSA PH4 monitor is a diagnostic measure of media bed status of the VOCSN Internal O2 Concentrator.
O2 Tank	21 - 100%	The O2 Tank monitor is a diagnostic measure of the oxygen concentration created by the internal O2 Concentrator.
System Usage	0 to 99,999 hours	The System Usage monitor displays the total duration of VOCSN operation over its life.
Time	12:00 AM to 11:59 PM	The Time monitor displays the configured time. Periodically check that the time setting is correct. To update the Time setting, see <i>"Changing Device Settings" on page 101</i> .
O2 Concentrator Usage	0 to 99,999 hours	On VOCSN configurations that include an internal O2 Concentrator, the Concentrator Usage monitor displays the total time Oxygen therapy has been active while set to deliver oxygen from the internal O2 Concentrator.

Multi-View

VOCSN Multi-View is the first comprehensive reporting solution for ventilator-dependent patients.

It is the first and only system to provide complete patient trending and monitoring for ventilator-dependent patients across multiple respiratory therapies including [Ventilation](#), [Oxygen](#), [Cough](#), [Suction](#), [Nebulizer](#), and additional patient monitors. Building on the integrated multi-therapy delivery of VOCSN, Multi-View is designed to summarize patient data and create trend reports to facilitate the delivery of seamless care across providers from hospital to home. The streamlined information is designed to provide a comprehensive picture of the patient's respiratory wellbeing that has never before been possible.



NOTE: Multi-View reports are for informational purposes only. Clinical decisions should be made based on observations of the patient, not solely the report.

NOTE: Use the [Reset Settings for New Patient](#) control in the [Device Settings](#) to restore VOCSN factory defaults and also reset Multi-View calculations. Reports generated after this event will display data from the time of this event forward.

Exporting Multi-View Data to a USB Drive

Using software versions 4.06 and later, VOCSN data can be exported to USB, then uploaded to the cloud to create Multi-View trending reports, which provide insight into the use of all 5 therapies over time including the frequency of alarms, settings changes, and monitored parameter trends.

To export Multi-View data to USB:



- 1 Install a USB drive into the USB port in the back of VOCSN.

NOTE: USB drives used with VOCSN must be USB 2.0 compatible, and formatted to FAT32. Do not plug anything else into the VOCSN USB port. To purchase a VOCSN compatible USB drive, see VentecLife.com/usbdrive.

- 2 Navigate to the Event Log by pressing **Menu** and then the **LOGS** button. Press the **Events** tab.
- 3 Select the **EXPORT** button to begin exporting Multi-View data to the connected USB drive. When the export is complete, press **OK** and remove the USB drive.

NOTE: VOCSN stores and exports Multi-View data for the past 90 calendar days of use. Previous data is overwritten.

- 4 Insert the USB drive into a computer, and open the "VOCSN" folder on the drive. Ensure you're connected to the Internet and double-click the "Click to open Multi-View.html" link to open the Multi-View portal. Follow the instructions on the Multi-View portal, and see "[Generating Multi-View Reports](#)" on page 130 for more information.

Generating Multi-View Reports

To generate Multi-View usage reports, have your VOCSN Multi-View exports at the ready on a USB or folder on your computer, and then:

1 Use the "Click to open Multi-View.html" link or use a web browser to navigate to VentecLife.com/Multi-View.

2 You can upload VOCSN Multi-View files to the report generator portal by dragging and dropping the "Multi-View_Exports" folder from your USB drive or computer, or by selecting "Browse" and finding the files you would like to generate reports from.

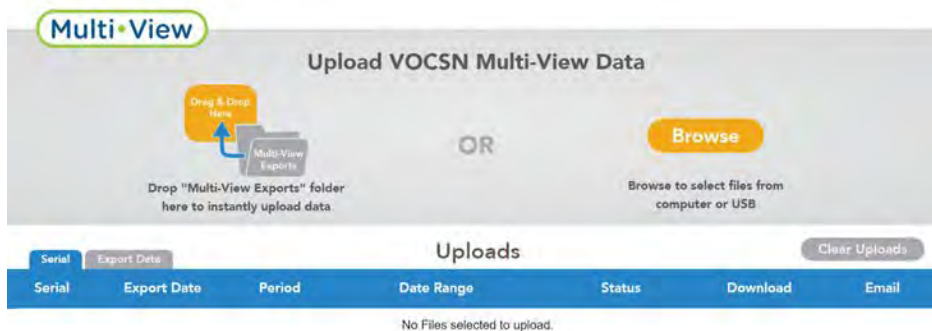

3 Whether you are uploading multiple files or just one, a pop-up window will appear allowing you to choose which report sections you would like to include, and what time period (and trend window) you would like the report to cover.

4 Make your selections and then click the "Create Reports" button to begin generating reports.

NOTE: To generate multiple reports with different durations from the same export file, create and download/email the first report, then select "Clear Uploads" and create the second.

5 The portal will begin processing the selected files immediately. When the "Status" column shows "Complete," you can download the report PDFs individually, as a group, or email them directly from the portal using the buttons on the right-hand side of the page.

Uploads							Clear Uploads
Serial	Export Date	Period	Date Range	Status	Download	Email	
113454	1/6/2020	7 Days	12/30/2019 13:16 to 1/6/2020 13:16	Complete			
113804	1/6/2020	7 Days	12/30/2019 13:15 to 1/6/2020 13:15	Processing	---	---	
113823	1/6/2020	7 Days	12/30/2019 13:16 to 1/6/2020 13:16	Queued	---	---	
113830	1/6/2020	7 Days	12/30/2019 13:10 to 1/6/2020 13:10	Queued	---	---	

Reading Multi-View Reports

This section provides detailed information on using and reading VOCSN Multi-View reports. Each section of the report provides insight into aspects of VOCSN therapy use and monitored trends.

Report Information

The first page of VOCSN Multi-View reports contain information about the VOCSN device, as well as the report itself. This page includes the device serial number, its configuration and the software version installed at the time of the Multi-View export. It also includes information about the report creation date, duration, and the date and time range of data included.

NOTE: To maintain data continuity, the dates and times used to display Multi-View data are anchored to the most recent VOCSN Date and Time control settings. Unlike the Event Log displayed on the VOCSN screen (which stamps events with whatever the VOCSN Date and Time settings were at the time the event occurred), Multi-View time is calculated backwards so that event times are relative to the most recent setting. This approach ensures the continuity of graphed and trended data in Multi-View reports, even through time zone, daylight savings, or other changes to the Date and Time controls on VOCSN.



Report Information

Serial Number	112848		
Configuration	V+O+C+S+N+Pro		
Report Creation Date	1/15/2020		
Report Duration	1-Week (data trended from last 24 hours)		
Report Date Range	1/7/2020 8:54 - 1/14/2020 8:54		
Report Sections	Trend Summary Settings Summary Alarm Summary	Monitor Details Therapy Log Alarm Log	Config Log Event Log
Patient	<input type="text"/>		
Patient Reference ID	<input type="text"/>		
Date of Birth	<input type="text"/>		
Equipment Used	<input type="text"/>		
Physician	<input type="text"/>		
Affiliation or Institution	<input type="text"/>		
Comments	<input type="text"/>		

This report is for informational purposes only. Clinical decisions should be made based on observations of the patient, not solely this report.

The report cover page also includes user-editable fields that can be used to record additional information about the report. To use these fields, open the PDF file, click one of the blank line items, and type in the desired value. Saving the report will also save the date you entered.

To use these fields, open the PDF file, click one of the blank line items, and type in the desired value. Saving the report will also save the date you entered.

NOTE: If you need to ensure that the data you enter into the form fields cannot be edited again, use a PDF reader to fill in the fields, and then select "Print" to print the file to PDF and lock your entries in place in the new file.

Trend Summary

The Multi-View Trend Summary section provides information on all five VOCSN therapies (Ventilation, Oxygen, Cough, Suction, and Nebulizer), including daily usage information, monitor averages, and trends.

Each box shows a different monitored parameter. The displayed average is calculated over the selected report duration. 7-day reports will include a 7-day average, 60-day reports will include a 60-day average, and so on.

At the bottom of each box (as applicable), a trend percentage is shown, with an up or down arrow. Trend values are calculated from the most recent section of the reported data range, to provide insight into any recent changes in how or when the therapies were used.

KEY

Parameter Name

units
(30-Day Average)

▲ ▼ %
(Last 7 Days Trend)

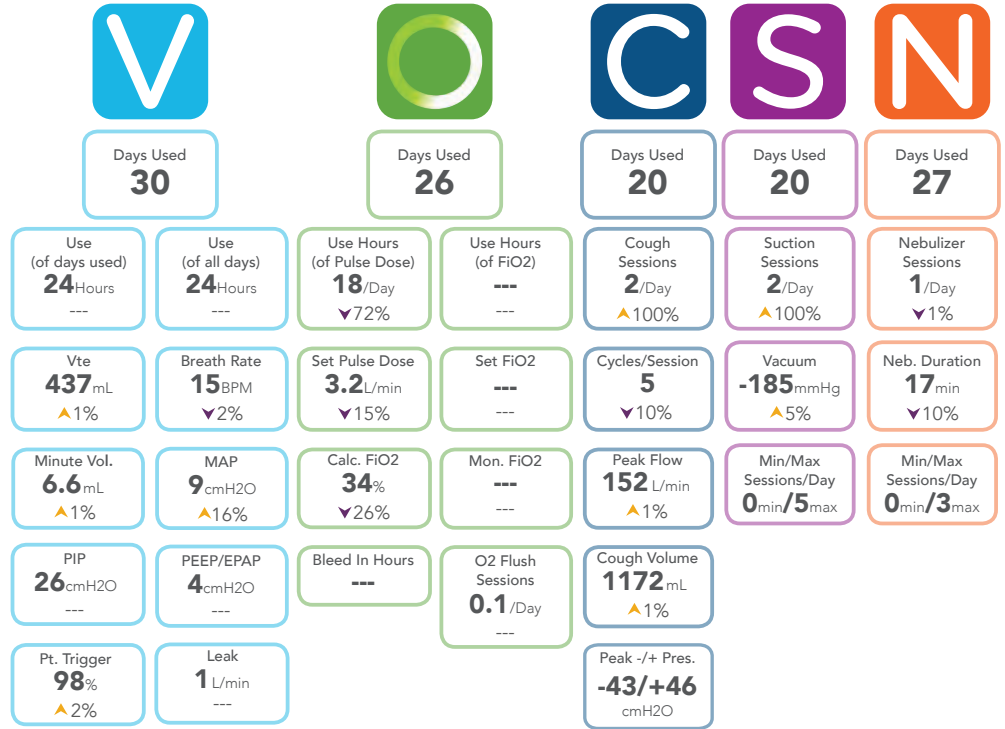

Compliance Calendar

The Multi-View compliance calendar provides an overview of how often therapies were used throughout the report range.

Ventilation and Oxygen are shown with a number below representing how many hours these therapies were used each day. Cough, Suction, and

Nebulizer are shown with a number that indicates how many times the therapy was started each day.

KEY

V O C S N

HOURS/DAY SESSIONS/DAY

NOTE: If the V, O, C, S, or N icon is not present, it means the corresponding therapy was not used during that calendar day.

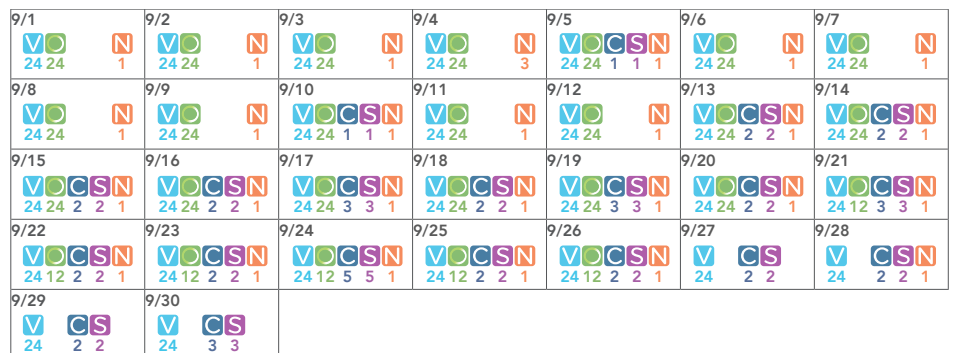

Therapy Use

Graphed therapy use provides instant insight into multi-therapy use and trends over time. In the example below, you can see how an increase in Cough therapy correlated with a decrease in Oxygen use.

These charts also show the time and duration of alarm activations during the reported period. Therapy use charts appear at the tops of pages to provide insight into settings changes and monitor values in the context of the frequency of all therapy uses over the reported period. The gray shaded area indicates the period of time trend values are calculated from.

NOTE: For reports generated from VOCSN device software versions 5.00 and later, you may see 'pins' in the therapy use chart, which correspond to Mark Event button presses. For more information on the Mark Event button, see *"The Mark Event Button"* on page 115.

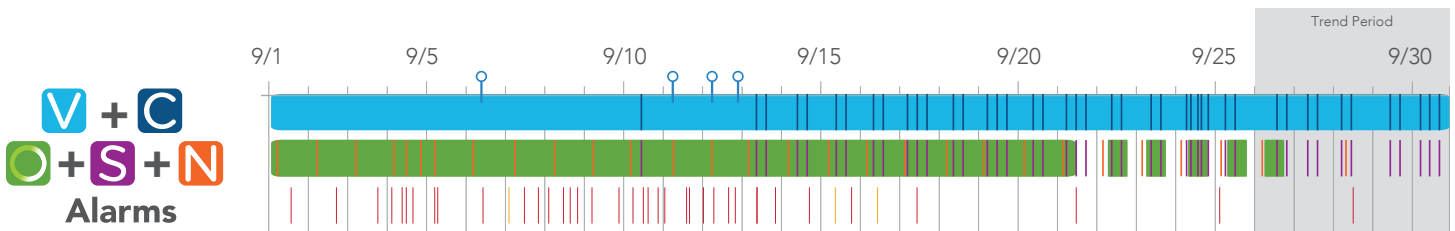

Settings Overview

The settings overview chart provides a visual representation of all VOCSN configuration changes.

The settings for the active Ventilation, Cough, or Oxygen preset are displayed. The default setting for Suction and Nebulizer is also shown, as well as the Device Settings.

Any control changes made over the report duration are graphed on the chart to show when they occurred, and what the setting was changed to.

Category	Setting	Value
Ventilation Settings	Mode	● Bi-Level
	Patient Type	● Adult
	Humidification	● HME
	Circuit Type	● Active with O2
	Breath Rate	● 12
	Backup Rate (BPM)	● 1.2
Oxygen Settings	Oxygen Source	● Internal O2 Concentrator
	Oxygen Delivery Mode	● Pulse Dose
	O2 Flow Equivalent (L/min)	● 3.5 → 3.0
Cough Settings	Insufflation Pressure (cmH2O)	● 25 → 30
	Exsufflation Pressure (cmH2O)	● -25 → -30
Suction Settings	Vacuum (mmHg)	● -180 → -195
Nebulizer Settings	Nebulizer Duration (minutes)	● 20 → 15
Device Settings	Alarm Volume	● Medium → High

Monitor Details

Use the Monitor Details section to view detailed information about changes in delivered therapies over time, in the context of multi-therapy use.

The boxes on the right-hand side of the page identify the monitor (including which therapy it's applicable to: **Ventilation**, **Oxygen**, or **Cough**). It also provides the average monitor value over the report range. Below, the report shows much the monitor increased or decreased during the trend window compared to the rest of the report range. At the bottom, the percentage increase or decrease this trend number represents is displayed.

The gray shading on the graphed portion of the monitor indicates the trend window. The range this window covers depends on what report duration was selected at the time the report was generated.

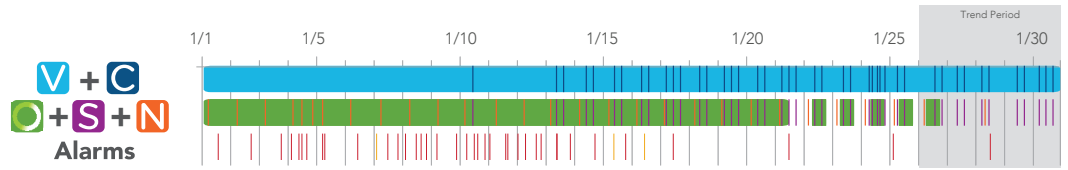

V Vte

30-Day Average
437 mL
7-Day Trend
+3.5 mL
▲0.8%

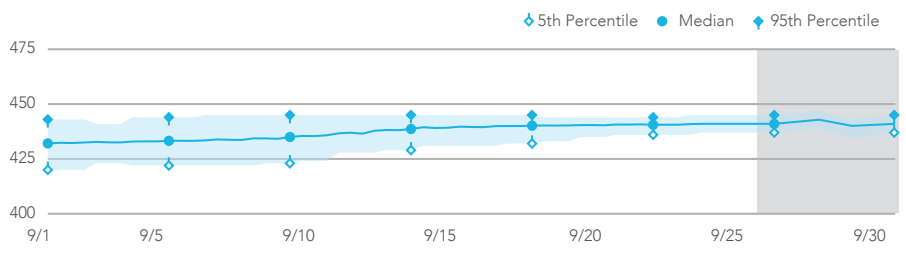

V Breath Rate

30-Day Average
15 BPM
7-Day Trend
-0.3 BPM
▼1.8%

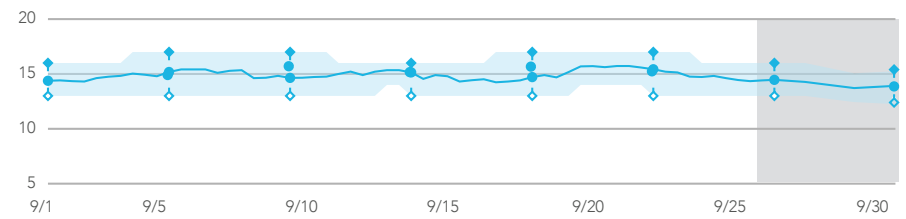

O Calc. FiO2

30-Day Average
34 %
7-Day Trend
-9 %
▼26%

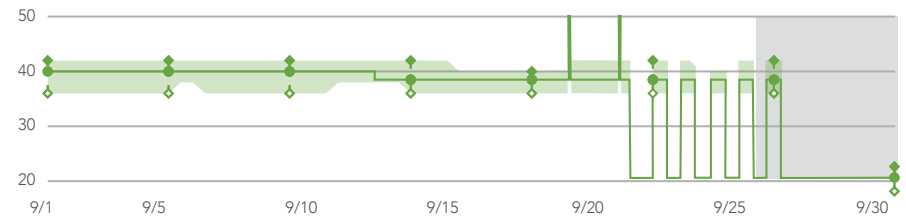

C Cough Peak Flow

30-Day Average
152 L/min
7-Day Trend
+2 L/min
▲1.3%

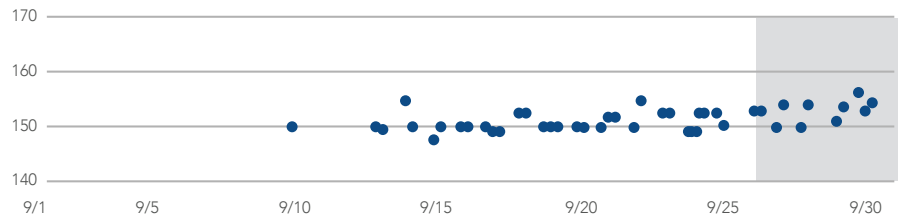

Logs

At the end of the report, you may choose to include detailed logs that include information about every user interaction with the VOCSN device over the report period. Multi-View provides four different optional Logs selections when generating a report:

- **Therapy Log** - The Therapy Log details the duration and start/stop times of all delivered VOCSN therapies including Ventilation, Oxygen, Cough, Suction, and Nebulizer.
- **Alarm Log** - The Alarm Log section shows every alarm activation, with its start/stop time and duration.
- **Configuration Log** - The Configuration Log includes detailed information about all VOCSN settings changes made over the report duration. It shows the time of the configuration event, as well as the previous and updated control values. Detailed sub-sections for System, Ventilation, Cough, Suction, and Nebulizer organize this information by therapy.
- **Event Log** - The Event Log is a combination of all three other logs, showing every user interaction with VOCSN over the report duration.

NOTE: To prevent generating reports that are too long to be usable, report Logs sections are limited in size.

Checkout Procedure

Ventec Life Systems recommends a series of checks and tests to ensure VOCSN is ready to use safely. Perform these tests before using VOCSN for the first time, and periodically during use. See “*Recommended Maintenance Schedule*” on page 10-7 for the maintenance schedule recommended by Ventec Life Systems.

NOTE: This chapter describes checkout procedures for Ventilation, Oxygen, Cough, Suction, and Nebulizer therapies. Test only those therapies that are enabled for use with VOCSN.

Visual Inspections

Inspect the exterior of VOCSN for signs of damage.

WARNING: Do not use VOCSN if it has evident signs of damage. External damage may be an indication of internal damage, and could adversely affect the performance of VOCSN. Contact your local Ventec Life Systems representative for service.

Inop Alarm Test

To verify the Inop alarm is functional:

- 1 Each time you power on VOCSN, listen for two audio tones. These tones verify the VOCSN backup alarm, which is used in case of an Inop alarm condition or an issue with the VOCSN speaker.
- 2 If you do not hear two audio tones when powering on VOCSN, contact your local Ventec Life Systems representative for service.

Power Testing Procedures

To verify that VOCSN power sources are functioning properly:

- 1** Verify that the two removable, rechargeable batteries are properly installed in the VOCSN battery wells.
- 2** Plug VOCSN into a source of external power, such as a wall outlet.
- 3** With VOCSN powered on, verify the following:
 - VOCSN operates.
 - The charge status indicator light on the front of VOCSN is lit (green or orange).
 - The three battery icons on the VOCSN touchscreen display a fully-charged status, or a lightning bolt appears on one of the three battery icons to indicate charging.
 - The external power icon () appears in the status bar.
- 4** Disconnect VOCSN from external power and verify:
 - VOCSN continues to operate on removable, rechargeable battery power.
 - The medium-priority Battery Use alarm activates.
 - The green external power indicator light on the front of VOCSN is not lit.
 - The two removable battery icons on the VOCSN touchscreen display the charge status noted in the previous step.

NOTE: The VOCSN batteries will not charge when overheated. Battery overheating may occur when VOCSN is run at settings that consume maximum power, and/or when it is operated in conditions outside its top environmental temperature range.

- 5** Disconnect the two removable batteries from VOCSN and verify:
 - VOCSN continues to operate on internal battery power.
 - The green external power indicator light on the front of VOCSN is not lit.

NOTE: Periodically verify that the batteries are functional, and that the Internal Battery Low and Internal Battery Critically Low alarms are functional, by disconnecting VOCSN from external power until the batteries drain and these alarms activate.

- 6** Reinstall the removable batteries, and plug VOCSN into an external source of power. Keep VOCSN plugged in until all batteries are fully charged. The charge status indicator light on the front of VOCSN will illuminate green when all VOCSN batteries are fully charged.

NOTE: Other steps in this checkout procedure may be performed while VOCSN batteries are charging.

NOTE: VOCSN battery icons on the touchscreen show the charge status of the batteries relative to when they were new. As the batteries age, their capacity will diminish. Ventec Life Systems recommends replacing batteries when they will no longer charge above 50%.

Ventilation and Oxygen Testing Procedures

Connect an active Ventec One-Circuit, flex tube, and a 1L (one liter) test lung to VOCSN to test Ventilation therapy. See *Chapter 2, "Setup"* for configuration instructions. To test VOCSN Ventilation therapy, first change the VOCSN control settings to those listed in the table below.

NOTE: See *"Changing Ventilation Therapy Settings"* on page 76 for configuration instructions.

NOTE: If testing VOCSN between patient uses, begin by restoring it to its factory defaults using the [Reset for New Patient](#) control in the [Device Settings](#).

NOTE: If VOCSN is in long-term use with a patient, these testing procedures may be performed using the existing VOCSN configuration. Periodically verify the monitors and alarms described in this chapter are functioning correctly.

NOTE: Some settings and alarms may not be applicable to a mouthpiece patient circuit setup. Configure and test only those settings and alarms that are available when the Circuit Type control is set to Mouthpiece.

Control	Setting
Circuit Type	Active (with O2 tube if using Pulse Dose oxygen)
Ventilation Mode	AC-Volume
Tidal Volume	500 mL
PEEP	10 cmH2O
Breath Rate	12 BPM
Inspiratory Time	1.7 seconds
Flow Trigger	4 L/min
Leak Compensation	On
High Inspiratory Pressure alarm	40 cmH2O
FiO2 or Pulse Dose/O2 Flow Equivalent (if prescribed)	30% FiO2, or 3 L/min O2 Flow Equivalent

NOTE: If Oxygen therapy is not enabled for use with VOCSN, this step may be skipped.

Ventilation And Oxygen Tests

After configuring Ventilation therapy using the settings described in *“Ventilation and Oxygen Testing Procedures”* on page 138, verify the complete the following steps while Ventilation therapy (and Oxygen therapy, if prescribed) is running:

NOTE: For mouthpiece patient circuit setups, these verification steps are not applicable.

NOTE: These ranges represent the combined tolerances of the delivered therapy and their independent monitor.

- 1 Run a Pre-Use Test. See *“Running the Pre-Use Test”* on page 50 for instructions.
- 2 Verify the Vte monitor reads between 374 and 642 mL.
- 3 Verify the PEEP monitor reads between 6 and 14 cmH₂O.
- 4 Verify the Leak monitor reads between 0 and 1 L/min.
- 5 Count the number of breaths delivered over one minute to verify the delivered Breath Rate is 12 BPM.
- 6 Verify VOCSN oxygen delivery:
 - If using an external source of high-pressure oxygen and the FiO₂ control, verify the delivered FiO₂ reads between 24% and 36%.
 - If using the internal O₂ Concentrator and the O₂ Flow Equivalent control, let the internal concentrator run until the Media Bed Status monitor on My VOCSN screen is out of “Warming Up” status.

NOTE: VOCSN may be in “Warming Up” status until the system optimizes oxygen values. Oxygen is being delivered to the patient during this time.

- If the Media Bed Status monitor changes to “Service” the concentrator failed the checkout test and should be serviced before use.

- 7 Verify there are no active alarms.

Ventilation Alarm Verification

To ensure alarms are functioning correctly, maintain the control settings configured as part of “*Ventilation and Oxygen Testing Procedures*” on page 138.

NOTE: When performed as a maintenance step during patient use, the VOCSN alarm system may be performed using existing VOCSN control settings.

Follow the procedures in the following pages, and verify the following while testing each alarm:

- The name of the alarm condition appears in the upper left-hand corner of the touchscreen.
- A blue, yellow, or red banner flashes across the top of the touchscreen.
- Audible alarm tones are emitted from VOCSN.
- When an alarm deactivates, verify that the flashing blue, yellow, or red banner disappears from the top of the touchscreen, and that the audible alarm tones stop.

Test each alarm as described in the sections below.

NOTE: VOCSN tests High PEEP, High Pressure, and High/Low FiO₂ alarms automatically. The Patient Circuit Disconnect and decannulation tests are designed to ensure the Patient Circuit Disconnect and Low Minute Volume alarms are functioning correctly. Activation of the Low Minute Volume alarm serves as verification the High Minute Volume is also functional.

Remote Alarm Test (Optional)

If using VOCSN with a remote alarm, verify that it is functioning properly before use:

- 1** Connect the remote alarm to VOCSN and follow all testing instructions provided by the remote alarm manufacturer.
- 2** Verify that the remote alarm activates with each of the alarm conditions described in the remainder of this alarm testing procedure.

Decannulation Alarm Verification

If using a Ventec One-Circuit with a tracheostomy tube, you may choose to verify that alarms activate with decannulation before use or periodically during use. Other patient circuit interfaces may also benefit from decannulation alarm verification. Follow your healthcare institution's protocol.

To verify decannulation causes alarms to activate:

- 1** If VOCSN is in use with a patient, provide an alternative means of Ventilation therapy to the patient.
- 2** Disconnect the Ventec One-Circuit from the patient's tracheostomy tube or from the test lung.
- 3** With a clean, gloved hand, connect the patient's emergency tracheostomy tube to the Ventec One-Circuit (without a test lung) and verify the appropriate alarms activate (Patient Circuit Disconnect and/or Low Minute Volume and/or Low Inspiratory Pressure).

NOTE: If alarms do not activate during the decannulation alarm verification procedure described, alarm settings may need to be adjusted, or other means of decannulation detection may need to be added to the VOCSN system.

- 4** Reconnect the Ventec One-Circuit to the patient tracheostomy tube or test lung.

Patient Circuit Disconnect Alarm Verification

To verify the Patient Circuit Disconnect alarm is functional, follow your healthcare institution's protocol, and:

- 1** If VOCSN is in use with a patient, provide an alternative means of Ventilation therapy to the patient.
- 2** Disconnect the Ventec One-Circuit from VOCSN at the bacterial filter and verify the appropriate alarms activate (Patient Circuit Disconnect and/or Low Minute Volume and/or Low Inspiratory Pressure).
- 3** Reconnect the Ventec One-Circuit and verify all active alarms deactivate.

Cough Therapy Testing Procedures

If VOCSN will be used to provide Touch Button Cough therapy to the patient, verify Cough therapy is functioning correctly by following this procedure.

- 1 Change the VOCSN Cough control settings to those listed in the table below.

NOTE: See *"Changing Cough Therapy Settings"* on page 94 for configuration instructions.

Control	Setting
Insufflation Pressure	40 cmH ₂ O
Exsufflation Pressure	-40 cmH ₂ O
Insufflation Time	1.7 seconds
Exsufflation Time	1.7 seconds
Pause Time	1.7 seconds

- 2 Begin Cough therapy using the configured settings.
- 3 Verify the pressure manometer reads between 27 and 54 cmH₂O during insufflation, and between -27 and -54 cmH₂O during exsufflation.
- 4 Verify that the System Fault alarm does not activate.

Suction Therapy Testing Procedures

If VOCSN will be used to provide Suction therapy to the patient, verify Suction therapy is functioning correctly by following this procedure.

- 1 Set the Vacuum control for Suction therapy to -180 mmHg and start Suction therapy.
- 2 Completely occlude the suction port or connected suction tubing so that it creates an air-tight seal.
- 3 Verify that the Suction therapy vacuum monitor reads between -132 and -228 mmHg.

Nebulizer Therapy Testing Procedures

If VOCSN will be used to provide Nebulizer therapy to the patient, verify Nebulizer therapy is functioning correctly by following this procedure.

- 1 Connect the nebulizer that will be used to provide therapy to the Ventec One-Circuit, a test lung, and the nebulizer drive port on the right-hand side of VOCSN. See *"Connecting a Nebulizer Cup to the Patient Circuit"* on page 37 for instructions.
- 2 Set the Nebulizer Duration control to 15 minutes, and start Nebulizer therapy. See *"Starting Nebulizer therapy"* on page 158 for instructions.
- 3 Verify the Vte monitor (available on the Monitors tab) reads between 374 and 642 mL.

NOTE: If the nebulizer is connected to a tee for use in a patient circuit, verifying the output flow from the connected nebulizer may require the occlusion of one end of the patient circuit connection port while measuring the output flow.

Configure and Verify Control and Alarm Settings

Before providing therapy to the patient, set the VOCSN control and alarm settings appropriately for the patient condition, and verify they are correct. See *"Controls and Settings"* on page 75 and *"Alarms"* on page 104 for configuration instructions and a description of available settings.

Verify the [Date](#) and [Time](#) settings are correct. These controls can be found in [Device Settings](#) on the [Menu](#) tab.

Checkout Worksheet

The checkout procedures listed in the following worksheet should be performed before using VOCSN on a patient, and periodically during use. Print and complete a copy of this worksheet to verify VOCSN checkout procedures were completed.

NOTE: If VOCSN is in long-term use with a patient, these testing procedures may be performed using the existing VOCSN configuration. Periodically verify the monitors and alarms described in this chapter are functioning correctly.

Function	Settings	Requirement	Pass / Fail / NA
Visual Inspection	N/A	No part of the device or connected components appear damaged	
Inop alarm	N/A	Two audible tones sound at VOCSN power up	
Power	N/A	VOCSN functions on external, removable battery, and internal battery power	
Ventilation and Oxygen	Circuit Type: Active (with O ₂ tube if using internal O ₂ Concentrator) Ventilation Mode: AC-Volume Tidal Volume: 500 mL PEEP: 10 cmH ₂ O Breath Rate: 12 BPM Inspiratory Time: 1.7 seconds Flow Trigger: 4 L/min Leak Compensation: On FiO ₂ : 30% (using external high-pressure oxygen), or 3 L/min O ₂ Flow Equivalent (using internal O ₂ Concentrator)	The Vte monitor reads between 374 and 642 mL	
		The Leak monitor reads between 0 and 1 L/min	
		The PEEP monitor reads between 8 and 12 cmH ₂ O	
		The delivered Breath Rate is 12 BPM	
		After 5 minutes, the FiO ₂ monitor reads between 24% and 36% (if used), and/or no O ₂ Concentration alarm activates	
Alarms	Maintain settings configured as part of Ventilation checkout procedure.	Decannulation causes Patient Circuit Disconnect and/or Low Minute Volume alarm to activate as expected	
		Disconnecting the Ventec One-Circuit causes Patient Circuit Disconnect and/or Low Minute Volume alarm to activate as expected	
		Remote alarm activates as expected (optional)	
Cough	Insufflation: 40 cmH ₂ O Exsufflation: 40 cmH ₂ O Insufflation Time: 1.7 seconds Exsufflation Time: 1.7 seconds Pause Time: 1.7 seconds	Pressure manometer reads between 27 and 54 cmH ₂ O during insufflation, and between -27 and -54 cmH ₂ O during exsufflation	
		The system fault alarm does not activate	
Suction	180 mmHg	Occlude suction port or tube and verify Suction therapy vacuum monitor reads between 132 and 228 mmHg	
Nebulizer	N/A	The Vte monitor reads between 374 and 642 mL	

VOCSN Serial Number: _____

Tester Name: _____ Date: _____

Signature: _____

Operating Instructions

Depending on the mix of therapies available and enabled on the device, VOCSN can be used to provide Ventilation, Oxygen, Cough, Suction, and/or Nebulizer therapy to the patient. This chapter describes how to start and use each of the therapies. See *"Controls and Settings"* on page 75 for therapy configuration instructions.

IMPORTANT NOTE: Only one of the following therapies can be delivered at a time: Oxygen, Suction, or Nebulizer. See *"VOCSN Therapy Interactions"* on page 103 for details. If continuous Oxygen therapy is critical to patient care, use an alternate means of delivering Suction and/or Nebulizer therapy.

WARNING: When in use for a prolonged period at its maximum environmental operating temperature, VOCSN may reach a temperature at the patient connection port of 43°C. To ensure patient safety, avoid prolonged use at maximum operating temperatures, and move the patient and the device to a cooler location if necessary. Use of VOCSN outside its recommended range of temperature, altitude, and/or relative humidity may adversely affect the ventilation and oxygen concentration flow rate from VOCSN, and may result in patient harm. See *"Environmental"* on page 194 for details.

WARNING: If critical to patient care, always have an alternative means of ventilation, oxygen, nebulization, and secretion management available. In case of unexpected VOCSN operation, failure to have alternative means of therapy available may result in patient harm or death.

WARNING: Do not use VOCSN within magnetic resonance (MR) environments. Using VOCSN within MR environments may affect VOCSN or MR device performance, damage the devices, or harm individuals.

WARNING: If the patient feels discomfort or experiences a medical emergency during Ventilation or Oxygen therapy, seek medical assistance immediately. Patients unable to communicate discomfort (such as geriatric or pediatric patients) may require additional monitoring and/or a distributed alarm system to alert the caregiver to the discomfort and ensure patient safety.

Powering On VOCSN

VOCSN will run on external power (such as a wall outlet), or on its internal and removable batteries. Ventec Life Systems recommends powering VOCSN with an external, continuous source of power whenever possible. See *“Power Setup”* on page 22 for instructions on connecting VOCSN to external power.

NOTE: After pressing the On/Off button, VOCSN will be ready to deliver therapy in ≤ 30 seconds.

- 1 Press the On/Off button on the front of VOCSN to power on the device.

NOTE: If VOCSN is in Battery Storage Mode, external power must be connected to activate the batteries and power on the device. See *“Battery Storage Mode”* on page 170 for more information.

- 2 Verify the state of all power sources before initiating therapy:

- If VOCSN is connected to external power, the power connection icon appears on the touchscreen, and the charge status indicator light on the front of VOCSN is illuminated.
- The two removable batteries are adequately charged, or charging.
- The internal battery is fully charged.

- 3 Check the VOCSN Date and Time settings, and adjust them if needed. See *“Changing Device Settings”* on page 101 for instructions.

If the internal battery depletes fully, VOCSN Date and Time settings will reset to their default values. To ensure the Alarm and Event logs record information accurately, verify the VOCSN Date and Time settings before use, and set them to the correct values if necessary.



Starting VOCSN Therapies

Although patients may be intended VOCSN operators for some functions, patients should not configure or initiate Ventilation, Oxygen, or Nebulizer therapy without supervision. Once configured by a clinician, some patients may be able to safely switch between Ventilation therapy Presets, as well as activate Touch Button Cough therapy and Suction when needed.

It is of vital importance that a caregiver or other supervisor capable of responding to any VOCSN alarms be present during VOCSN therapy. The VOCSN clinician or caregiver must be capable of responding to alarm conditions, and trained to use VOCSN. A list of available VOCSN training options is available at VentecLife.com.

To ensure the delivered therapy is adequate, monitor the patient each time VOCSN is started, control settings are modified, an accessory is attached, or the Ventec One-Circuit is reconfigured. The operator of VOCSN should be within range of the audible VOCSN alarm tones. Place VOCSN so that any monitors critical to patient care are visible.

WARNING: Do not use VOCSN with helium (including mixtures with helium), nitric oxide, or in a hyperbaric chamber. VOCSN has not been validated for safe use with helium, nitric oxide, or for use in a hyperbaric chamber.

NOTE: If VOCSN performs unexpectedly, prepare an alternate means of ventilation, monitor the patient, and contact your local Ventec Life Systems representative for service.

Starting Ventilation Therapy

To begin Ventilation therapy using VOCSN, first ensure the Ventec One-Circuit is correctly configured, and all Ventilation therapy controls and alarms are set appropriately for the patient condition.

WARNING: Always have a backup means of ventilation available (such as a backup ventilator or manual resuscitator) in case of VOCSN failure. Inability to immediately access an appropriate alternative means of ventilation may result in death for patients dependent on Ventilation therapy.

NOTE: When VOCSN is used to provide critical care, an active Ventec One-Circuit with proximal flow sensor is required to verify the accuracy of delivered Ventilation therapy.

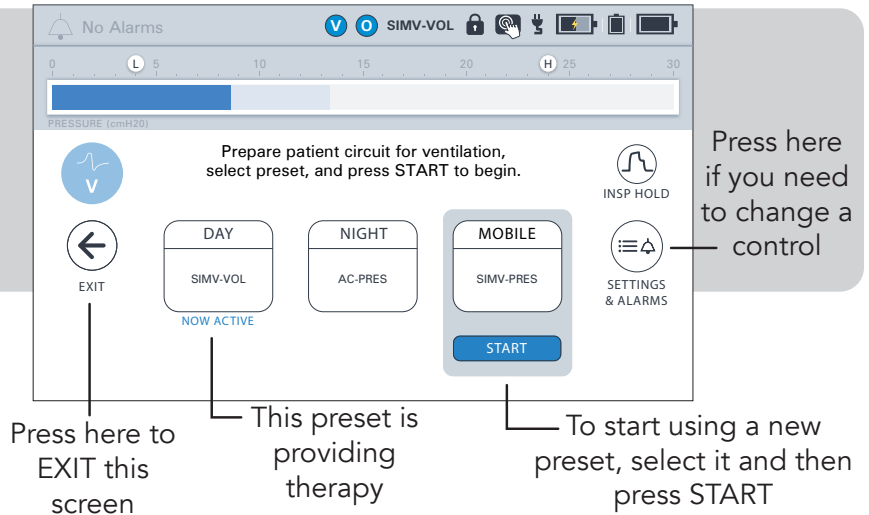

NOTE: If a speaking valve is used, Ventec Life Systems recommends use of an active Ventec One-Circuit and/or pressure mode of ventilation. See *"Setting up Ventilation therapy with a Speaking Valve"* on page 39 for more information.

To begin ventilation therapy:

- 1 Connect the Ventec One-Circuit and any patient circuit components. See *"Setup"* on page 20 for instructions.
- 2 Press the On/Off button.
- 3 Verify that the set Ventilation therapy controls and alarms are set correctly, and that the correct Ventilation therapy Preset is active.

NOTE: To verify or change Ventilation therapy settings, press the **EXIT** button on the Pre-Use Test screen. Follow the instructions described in *"Changing Ventilation Therapy Settings"* on page 76.

- 4 Run the Pre-Use Test.

NOTE: If the Pre-Use Test screen does not appear automatically, run a user-initiated Pre-Use Test by pressing the **Menu** tab, and then the **PRE-USE TEST** button.

NOTE: If used, remove the HME from the Ventec One-Circuit to ensure the Pre-Use Test passes and correctly calculates the Ventec One-Circuit resistance.

- 5 Ventilation therapy will begin. For information about monitored Ventilation therapy parameters, see *"Ventilation Monitors"* on page 119.

Changing Between Configured Ventilation Presets

VOCSN can be configured with up to three different Ventilation therapy Presets. To begin Ventilation therapy using a different Preset:

- 1** Press the **Therapy** tab, and then press the **Ventilation** therapy icon.
- 2** Press the name of the Preset you want to activate.
- 3** Press **START** on the bottom of the screen to begin Ventilation therapy using the selected Preset control and alarm settings.

NOTE: If the Circuit Type control of the selected ventilation Preset is set to a value different than the existing Preset, you will be prompted to modify the Ventec One-Circuit accordingly and run a Pre-Use Test prior to reinitializing Ventilation therapy. If time constraints make running the test inadvisable, press the **EXIT** button to immediately initiate Ventilation therapy with the selected Preset.

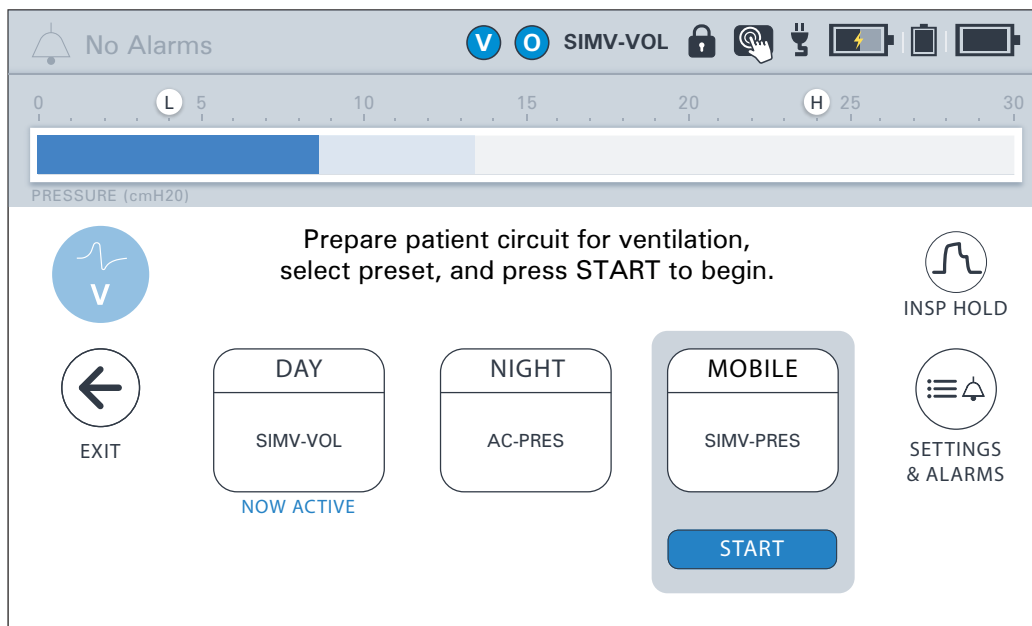

NOTE: To change Ventilation therapy settings press the Preset name and then the **SETTINGS & ALARMS** button. Follow the instructions described in *“Changing Ventilation Therapy Settings”* on page 76 to modify Ventilation therapy settings. When configuration is complete, press **< EXIT** to return to the Ventilation therapy screen.

Starting Oxygen Therapy

The VOCSN configuration can be configured to provide Oxygen therapy from its internal O2 concentrator as a pulse dose, or from an external source of high-pressure oxygen to provide pulse dose or a set FiO2. Low-pressure oxygen sources can also be used, and are additive. See *"Oxygen Therapy Setup"* on page 41 for details.

NOTE: The oxygen source options available on VOCSN depend on its configuration. See *"Therapy Overview"* on page 12 for more information.

To configure Oxygen therapy presets, select a preset and then press the **SETTINGS & ALARMS** button. Use the blue **START** button to activate an oxygen preset. The **O2 FLUSH** button can be used at anytime to deliver oxygen at maximum FiO2 or Pulse Dose settings.

For more information about Oxygen therapy controls and available settings, see *"Oxygen Controls"* on page 91.

The screenshot shows the Oxygen Therapy control interface. At the top, it displays 'No Alarms' and 'SIMV-VOL'. Below is a pressure gauge (0-30 cmH2O) and a 'CALCULATED FIO2 MONITOR (%)' gauge (21-100%). Three presets are shown: PRESET 1 (4 L/min Pulse Dose, Ext. High-Pressure), PRESET 2 (40% FiO2, Ext. High-Pressure), and PRESET 3 (6 L/min Pulse Dose, Int. O2 Concentrator). The 'START' button is highlighted under PRESET 3. Other buttons include 'EXIT', 'O2 FLUSH', and 'SETTINGS & ALARMS'. Annotations point to these buttons with the following text:

- Press here to EXIT this screen (points to the EXIT button)
- This preset is providing therapy (points to PRESET 3)
- To start using a new preset, select it and then press START (points to the START button)
- O2 Flush delivers maximum oxygen for 3 minutes (points to the O2 FLUSH button)
- Press here if you need to change a control (points to the SETTINGS & ALARMS button)

NOTE: A low-pressure oxygen source may also be used as an additive or alternate source of Oxygen therapy, not controlled using the VOCSN Oxygen therapy settings.

WARNING: The O2 Concentration alarm may take more than five minutes to activate, depending on VOCSN therapy settings. If the patient’s prescribing healthcare professional determines Oxygen therapy is critical to patient care, provide continuous monitoring, such as pulse oximetry or proximal FiO2 monitoring.

NOTE: Oxygen therapy can be hazardous to patients with certain medical conditions. Always seek professional medical advice before using VOCSN to provide oxygen therapy to a patient

NOTE: Hot, humid environments may reduce the oxygen generation capacity of the internal O2 Concentrator.

NOTE: Oxygen therapy (from the internal O2 Concentrator or a source of external high-pressure oxygen) will suspend during Suction or Nebulizer therapy. Pulse dose Oxygen Direct therapy will pause during Cough. Oxygen therapy automatically resumes once these therapies complete.

WARNING: Do not smoke near elevated oxygen levels. Smoking near elevated oxygen levels greatly increases the risk of fire, and may result in facial burns or death. Do not smoke in the same room as, or produce open flames within 2 meters of, a running oxygen concentrator or other oxygen sources or accessories that are in use. Leave the room containing the oxygen source if smoking.

WARNING: Do not bleed oxygen into the Ventec One-Circuit from an external source not connected to one of the VOCSN oxygen input ports. Bleeding oxygen directly into the Ventec One-Circuit may increase the patient's tidal volume, or affect breath triggering.

WARNING: The O2 Flow Equivalent control setting may not result in a flow that corresponds to bleeding a continuous flow of oxygen into a ventilator. Monitor patient oxygenation and adjust the O2 Flow Equivalent control appropriately for the patient condition to ensure patient safety.

Using O2 Flush

The **O2 FLUSH** button on the Oxygen screen delivers either 100% FiO₂, or 6 L/min O2 Flow Equivalent (depending on the selected O2 Delivery Mode) for 3 minutes.

A blue fill around the button indicates the approximate time remaining. After 3 minutes, the O2 Flush will stop, and oxygen will resume delivery at the activated preset setting.

During delivery, use the **STOP O2 FLUSH** button under the timer to cancel the O2 Flush and resume delivery at the activated preset setting.

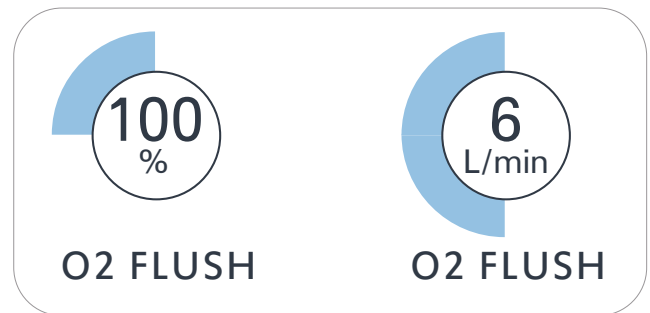

NOTE: To help ensure patient safety, active Oxygen therapy presets cannot be stopped until O2 Flush is completed or canceled. Starting a new Oxygen therapy preset will automatically cancel an active O2 Flush session, and instead begin Oxygen therapy at the new preset settings.

Using the Internal O2 Concentrator to Provide Pulse Dose Oxygen Direct Therapy

The VOCSN internal O2 Concentrator is used to provide Oxygen Direct therapy to the patient in Pulse Dose mode, through a Ventec One-Circuit O2 tube. To use the VOCSN internal O2 Concentrator:

- 1 If not already enabled, set the **O2 Concentrator** control in the **Enabled Prescribed Therapies** menu to **Enabled**.
- 2 Verify a Ventec One-Circuit O2 tube is connected to the O2 port on the right side of VOCSN. See *"Connecting a Ventec One-Circuit O2 Tube"* on page 33 for setup instructions.

NOTE: Ensure the O2 tube is firmly connected. Ventec recommends verifying patient oxygenation and setting the Low Inspiratory Pressure and Low Minute Volume alarms appropriately for the patient condition to detect O2 tube disconnections.

- 3 Using one of the three available Oxygen therapy Presets, set the **Oxygen Source** control to **Internal O2 Concentrator**. The Oxygen Delivery Mode control will be automatically set to Pulse Dose.
- 4 Set the **O2 Flow Equivalent** control to provide the prescribed Oxygen Direct therapy to the patient.

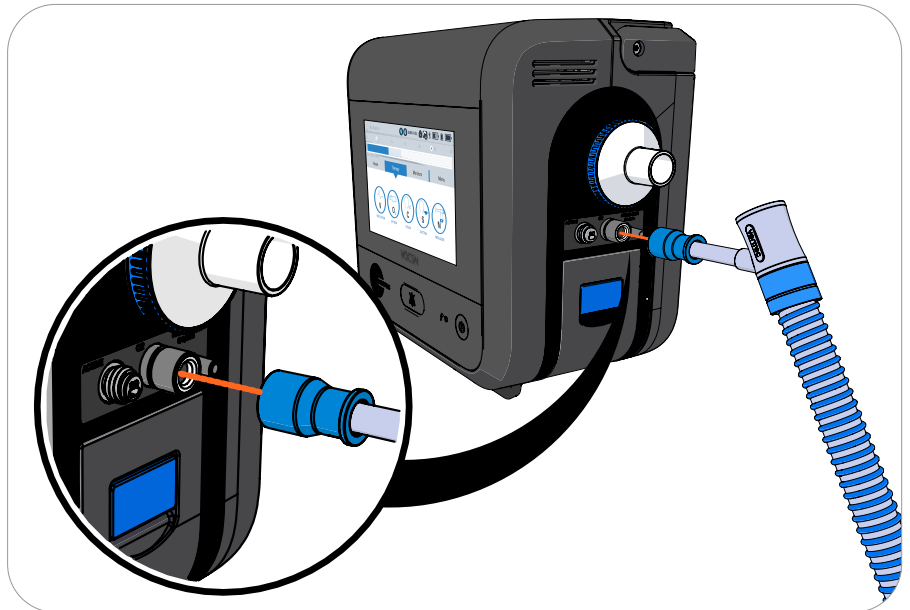

NOTE: See *"Changing Oxygen Settings"* on page 91 for detailed configuration instructions.

- 5 If not already active, start the configured Oxygen therapy Preset, and run the Pre-Use Test as needed.

Using External High-Pressure Oxygen

External sources of high-pressure oxygen can be used with VOCSN to provide FiO₂ or Pulse Dose Oxygen therapy. To provide Oxygen therapy from an external source of high-pressure oxygen:

- 1 Verify an external source of high-pressure oxygen is connected to VOCSN. See *"Connecting External High-Pressure Oxygen"* on page 43 for setup instructions
- 2 Using one of the three available Oxygen therapy Presets, set the **Oxygen Source** control to **External High-Pressure**.
- 3 Set the **Oxygen Delivery Mode** control to **FiO₂** or **Pulse Dose**, depending on the desired oxygen delivery mode.
- 4 Set the **FiO₂** or **O₂ Flow Equivalent** control to provide the prescribed Oxygen therapy to the patient.

NOTE: See *"Changing Oxygen Settings"* on page 91 for detailed instructions.

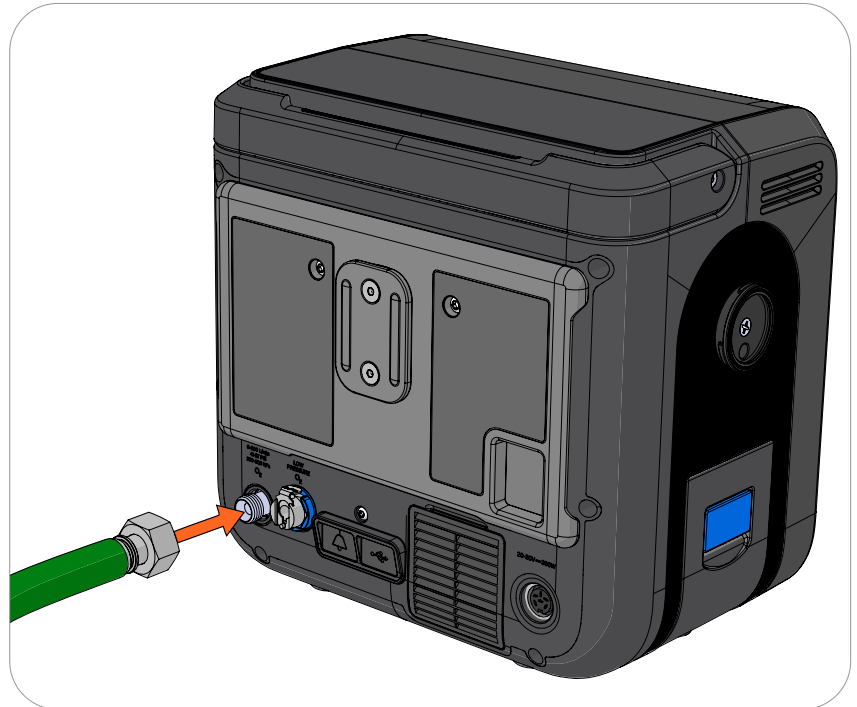

NOTE: Whenever the FiO₂ control is set above 21%, use the FiO₂ monitor and set the High FiO₂ and Low FiO₂ alarms appropriately for the patient condition.

NOTE: If the delivered FiO₂ is lower than expected due to large leaks in the patient circuit, additive low-pressure oxygen may be used to raise it. See *"Connecting External Low-Pressure Oxygen"* on page 44 for more information. It is important to remove the low pressure oxygen adapter when not in use.

- 5 If not already active, start the configured Oxygen therapy Preset, and run the Pre-Use Test if prompted.

Using External Low-Pressure Oxygen

See *"Connecting External Low-Pressure Oxygen"* on page 44 for instructions on using VOCSN with low-pressure oxygen sources.

Starting Cough Therapy

VOCSN can be configured to provide Touch Button Cough therapy to patients who benefit from high air flows to clear secretions effectively.

NOTE: Cough therapy and Suction therapy can be initiated at the same time. On the Cough therapy screen, press the Settings button and set the Cough+Suction control to On for any or all of the three Cough Presets. Suction will begin at the start of the first Cough therapy insufflation, at the default set Suction setting, and run throughout the configured number of Cough Cycles plus an additional 2 minutes.

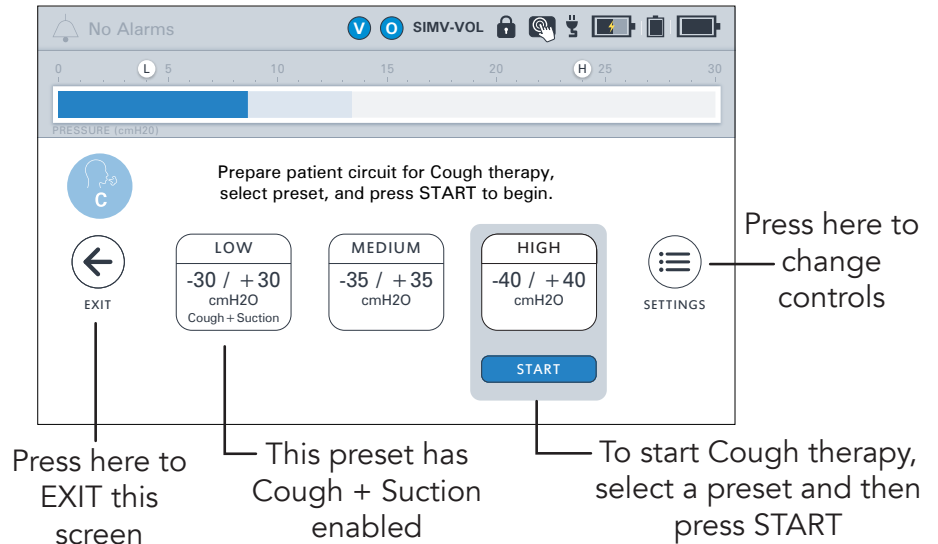

CAUTION: To prevent nebulized material from reaching VOCSN, Cough therapy should not be activated during External Nebulizer Compensation. Remove the connected external nebulizer and pause External Nebulizer Compensation before activating Cough therapy.

To provide Touch Button Cough therapy:

- 1 Press the **Therapy** tab, and then the **Cough** button.
- 2 If needed, set the Cough controls to provide the prescribed therapy. See *"Cough Therapy Controls"* on page 94.
- 3 Ensure the desired Cough Preset is selected, and then press **START** to begin Touch Button Cough therapy.

NOTE: If Breath Sync is set to On, coughs will be delivered when triggered by the patient as determined by the Flow Trigger setting configured using the Ventilation therapy controls.

- 4 Cough therapy will deliver the configured number of Cough Cycles, unless Cough therapy is stopped using the **STOP** button. During Cough therapy, the VOCSN will display a monitors screen with information about the delivered therapy. See *"Cough Therapy Monitors"* on page 125 for more information.
- 5 When the configured Cough therapy completes, Ventilation therapy will resume automatically.

NOTE: Large leaks in the patient circuit, including the use of masks with an integrated leak, may impair the effective delivery of Cough therapy. Minimize leaks in the patient circuit, and temporarily replace a connected mask incorporating an integrated leak with a mask that does not incorporate an integrated leak during Cough therapy.

Starting Suction Therapy

With a connected Ventec Travel Suction Canister, suction tubing, and a suction interface (such as a closed- or open-suction catheter) VOCSN provides optional Suction therapy to help remove secretions from the Ventec One-Circuit or patient airway.

Pressure modes of ventilation automatically compensate for the negative flow generated by Suction therapy. Ventilation therapy delivered in volume modes (Assist/Control-Volume or SIMV-Volume) may be affected by Suction therapy. When using a volume mode of ventilation with Suction therapy, monitor the patient to ensure ventilation flow is sufficient, or switch to pressure ventilation mode while suctioning.

Follow your healthcare institution's protocol to ensure Suction therapy is delivered safely. To help ensure safe suctioning of the patient, Ventec Life Systems recommends following the American Association for Respiratory Care (AARC) Guidelines when appropriate for the patient condition, which suggest -80 to -100 mmHg for infants, -100 to -120 mmHg for children, and -100 to -150 mmHg for adults.

NOTE: Cough therapy and Suction therapy can be initiated at the same time. On the Cough therapy screen, press the Settings icon and set the Cough+Suction control to On for any or all of the three Cough Presets. Suction will begin at the start of the first Cough therapy insufflation at the default set Suction setting, and run throughout the configured number of Cough Cycles plus an additional 2 minutes.

NOTE: If running, Oxygen therapy (from the internal O2 Concentrator or a source of external high-pressure oxygen) will suspend during Suction therapy. Oxygen therapy automatically resumes once Suction therapy is complete. See "VOCSN Therapy Interactions" on page 103 for more information.

The screenshot shows the Suction Therapy control screen. At the top, it displays 'No Alarms', 'SIMV-VOL', and various system icons. A pressure gauge is centered, showing a current reading of 185 mmHg. To the left of the gauge is an 'EXIT' button with a back arrow. Below the gauge is a large blue 'START' button. To the right of the gauge are three buttons: a '+' button labeled 'VACUUM', a '-' button, and a 'SET DEFAULT' button with a downward-pointing triangle. Callout lines connect these buttons to descriptive text below the screen.

Press here to exit this screen

Press here to start or stop Suction therapy

Press + and - to increase or decrease vacuum intensity

Press here to set the default Vacuum setting (It will also apply to Cough+Suction)

To provide Suction therapy:

- 1** If the Ventec One-Circuit is not already set up to provide Suction therapy, follow the instructions in *"Oxygen Therapy Setup"* on page 41.
- 2** Press the **Therapy** tab, and then press the **SUCTION** button.
- 3** If needed, set the Vacuum control to provide the prescribed suction intensity by using the up and down arrows. See *"Changing Suction Settings"* on page 97 for more information.
- 4** Press **START** to begin Suction therapy.
- 5** Verify there are no leaks and that Suction therapy is functioning as intended by occluding the suction tubing or attached catheter with a clean, gloved hand. Observe the suction monitor (indicated by the solid fill inside the arc) and verify it matches the set vacuum value (displayed as a numeric value inside the arc, and a black line).

NOTE: At high altitudes, the delivered vacuum may be lower than the set value. If necessary, set the vacuum control higher to achieve the desired suction at high altitudes.

- 6** Suction therapy will run at the set Vacuum intensity for two minutes, or until deactivated by pressing the **STOP** button.

NOTE: Suction therapy automatically stops two minutes after the last user interaction with the VOCSN touchscreen.

NOTE: If the Ventec Travel Suction Canister overfills, Suction will stop. Replace the Ventec Travel Suction Canister by following the instructions in *"Emptying the Ventec Travel Suction Canister and Replacing Suction Components"* on page 164 before resuming Suction.

NOTE: If any liquid or solid secretions have been drawn into the VOCSN internal vacuum pump, discontinue use of the system and contact your local Ventec Life Systems representative for service.

NOTE: The suction pump includes an electronic sensor that monitors the pressure created by VOCSN and the pressure generated inside the suction collection container. If the pressure in the container and VOCSN become unequal, suction will stop automatically. This feature prevents the backup of fluid to the pump or patient.

Starting Nebulizer therapy

With a connected nebulizer cup and nebulizer tubing, VOCSN provides optional Nebulizer therapy to administer medication to the patient. VOCSN can also be configured to compensate for the flow added to the patient circuit from an external 6 L/min nebulizer. Nebulizer therapy is intended to be used with a 6 L/min nebulizer cup connected to the Ventec One-Circuit.

NOTE: Variations in the characteristics of nebulizer cups can affect the accuracy of delivered Tidal Volumes during ventilation, particularly for patients with inspiratory flows <15 L/min. When starting patients on Nebulizer therapy, verify they are receiving adequate ventilation before leaving them unattended.

Press here to EXIT this screen

Press here to start internal Nebulizer therapy

Press here to select external nebulizer compensation

Press here to increase or decrease how long the nebulizer runs

NOTE: If running, Oxygen therapy (from the internal O2 Concentrator or a source of external high-pressure oxygen) will suspend during internal Nebulizer therapy. Oxygen therapy automatically resumes once internal Nebulizer therapy is complete. Nebulizer therapy from VOCSN will terminate if Suction therapy is activated, and pause if Cough therapy is activated. External Nebulizer Compensation is not affected by other therapies. See *“VOCSN Therapy Interactions” on page 103* for details.

NOTE: If Oxygen therapy is critical to patient care, it is important to understand the effect of External Nebulizer Compensation on oxygenation, particularly for patients receiving small Tidal Volumes. For a detailed description of the External Nebulizer Compensation feature, including recommendations for maintaining the intended patient oxygenation, see *“External Nebulizer Compensation” on page 220*.

CAUTION: To prevent nebulized material from reaching VOCSN, Cough therapy should not be activated during External Nebulizer Compensation. Remove the connected external nebulizer and pause External Nebulizer Compensation before activating Cough therapy.

CAUTION: VOCSN Nebulizer therapy is not recommended during High Flow therapy for pediatric patients receiving <15 L/min. At Flow settings of <15 L/min, the accuracy of the delivered flow may be affected by Nebulizer therapy. While not recommended, Flow settings of 4 or 5 L/min will display as 6 L/min during Nebulizer therapy (and may not accurately represent the actual flow delivered) because of added flow through the nebulizer.

When activated, the nebulizer drive or compensation runs continuously for the set Nebulizer Duration, during both inhalation and exhalation. To provide Nebulizer therapy:

- 1 Connect a nebulizer by following the instructions in *"Connecting a Nebulizer Cup to the Patient Circuit"* on page 37.
- 2 Press the **Therapy** tab, and then press the **NEBULIZER** button.
- 3 If needed, set the Nebulizer Duration control by using the plus (+) and minus (-) buttons. See *"Changing Nebulizer Settings"* on page 98 for more information.
- 4 Select **Internal Neb. Therapy** to provide therapy from the VOCSN nebulizer drive (available on configurations with Nebulizer therapy), or **External Neb. Compensation** to compensate for the flow from an external nebulizer (available on all configurations). Press **START** to begin Nebulizer therapy.
- 5 Nebulizer therapy will run for the set Nebulizer Duration, or until deactivated by pressing the **STOP** button.

NOTE: Every 10 minutes, internal Nebulizer therapy will pause for 6 seconds, and then automatically resume.

NOTE: High Pressure alarms will cause internal Nebulizer therapy delivery to briefly pause, though the Nebulizer Minutes Remaining monitor will continue to decrement. Frequent high pressure alarms may cause material in the cup to nebulize more slowly than expected.

- 6 When Nebulizer therapy is complete, disconnect the nebulizer from the VOCSN nebulizer port, and then from the patient circuit.

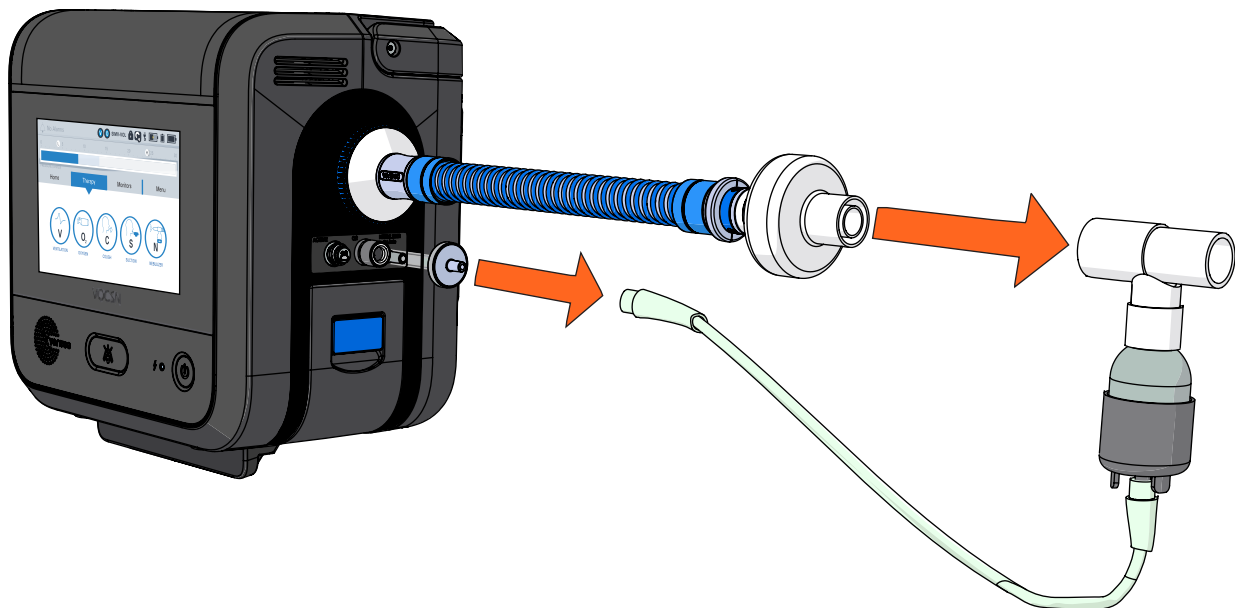

Responding to Alarms

The VOCSN operator must be capable of responding to alarm conditions and promptly performing the necessary corrective actions. See *"Alarms" on page 104* for information on each alarm condition. In case of VOCSN malfunction, the operator must be able to promptly provide an alternative means of ventilation.

Powering Off VOCSN

To power off VOCSN, press and hold the On/Off button for at least three seconds. Release the button and then press OK on the touchscreen to confirm and power off VOCSN.

If the VOCSN touchscreen is not accessible, you may also press and hold the On/Off button for at least ten seconds. A pop-up will appear while the backup alarm sounds and the Alarm Silence button flashes. Within 10 seconds, press and hold the Alarm Silence button until the VOCSN touchscreen indicates the device is shutting down.

Cleaning and Maintenance

The organization responsible for the use and maintenance of VOCSN should perform all adjustments, cleaning, and disinfection of VOCSN. Follow all instructions provided in this Clinical and Technical manual to prevent damage to VOCSN during cleaning and maintenance procedures.

NOTE: All VOCSN single-patient use components and Ventec One-Circuits, including the Ventec Travel Suction Canister, suction tubing, and Ventec Humidifier Bypass are not intended for cleaning, sterilization, or re-use. Replace VOCSN single-patient use components and Ventec One-Circuits regularly, following your healthcare institution's protocol.

Cleaning VOCSN

Before cleaning any part of VOCSN, disconnect external power sources.

WARNING: Do not perform maintenance or service on VOCSN while it is powered on or in use. Maintenance, or service procedures performed during use may temporarily alter the performance of VOCSN and result in patient harm.

WARNING: Do not touch the patient and parts inside the VOCSN enclosure simultaneously. High flows of electricity are present inside VOCSN enclosure and may be an electrocution hazard.

WARNING: Do not use ozone or any other non-approved cleaning materials on any part of VOCSN, or exceed its recommended storage temperature or humidity ranges to disinfect it.

Cleaning VOCSN Exterior

Clean the exterior of VOCSN every three months during use, between patient uses, or as needed if exposed to contaminants.

1 Unplug VOCSN from any connected external power sources. Ozone, abrasive cleaners and materials may damage the casing or display. Use only cleaning materials recommended in this manual. Clean the entire exterior surface with one of the following wipes or solutions with a soft cloth:

- Solutions: Water (including water mixed with soap or a mild detergent), 70% isopropyl alcohol, MadaCide FD, Metrex CaviCide1
- Wipes: MadaCide FDW, Metrex CaviWipes, PDI Super Sani-Cloth, PDI Sani-Cloth Plus, Diversey Oxivir, or Safetec SaniZide Plus

NOTE: Pay close attention to the LCD screen while cleaning, to ensure buttons on the touchscreen are not unintentionally pressed. Ventec recommends locking the touchscreen using the lock screen button in the status bar, and then gently wiping over the top of and across the touchscreen to clean it. This technique helps prevent inadvertent button presses.



- 2** Do not allow liquid to drip through VOCSN exterior casing or into the removable battery well. Use a soft, dry cloth to remove any residual moisture after cleaning.
- 3** Visually inspect VOCSN to verify it is clean. Repeat the cleaning steps described above until VOCSN passes a visual inspection.
- 4** Let VOCSN dry completely after cleaning before plugging it in to an external power source.

Cleaning the Air and Fan Filters

Clean the air and fan filters every two weeks to ensure VOCSN internal components are protected from dirt and dust. Replace the filters every six months, or as needed due to damage.

- 1** Power off and unplug VOCSN.
- 2** Remove the air and fan filters.
- 3** Inspect the air and fan filters for dirt or damage.
- 4** Wash the air and fan filters using warm water and soap or a mild detergent.
- 5** Rinse the filters thoroughly under running water to remove all soap or detergent residue.
- 6** Place the filters on a clean surface and allow them to dry completely.
- 7** Inspect the filters for signs of damage or contamination. Replace the filters if they appear damaged. Repeat the cleaning steps described above until the filters pass a visual inspection for cleanliness.

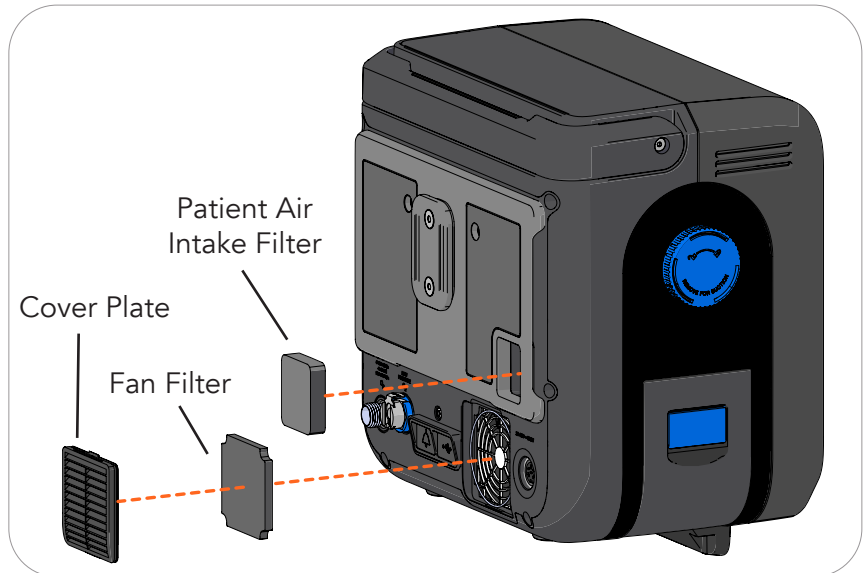

NOTE: Replacement air filters are available from Ventec Life Systems.

- 8** Reinstall the air and fan filters. Reinstall cover plate with slats on cover facing down.

NOTE: Check to ensure the black o-ring is installed around the exterior of the fan filter cover grate.

Replacing Components

Emptying the Ventec Travel Suction Canister and Replacing Suction Components

Inspect the Ventec Travel Suction Canister, suction tubing, and/or catheters regularly for signs of wear and damage. Do not use Suction components that have evident signs of damage.

Inspect the Ventec Travel Suction Canister daily to prevent overflow and contamination of the Ventec One-Circuit and VOCSN. If the Ventec Travel Suction Canister fills past its 300 mL capacity, Suction therapy will automatically stop.

The Ventec Travel Suction Canister and suction tubing are intended for single-patient use. Replace the canister and/or tubing between patient uses, or whenever they become contaminated or damaged. Follow your healthcare institution's protocol for canister and tubing replacement criteria.

Empty the canister before it fills to its 300 mL capacity. To empty the canister:

- 1** Disconnect the canister from VOCSN and then twist the knob counterclockwise to the dot position.
- 2** Then, pull the knob out of the canister.
- 3** Align the knob with the dot on the canister and press in to reinstall it. Then, connect the canister to VOCSN. See *"Connecting the Ventec Travel Suction Canister"* on page 46 for detailed instructions.

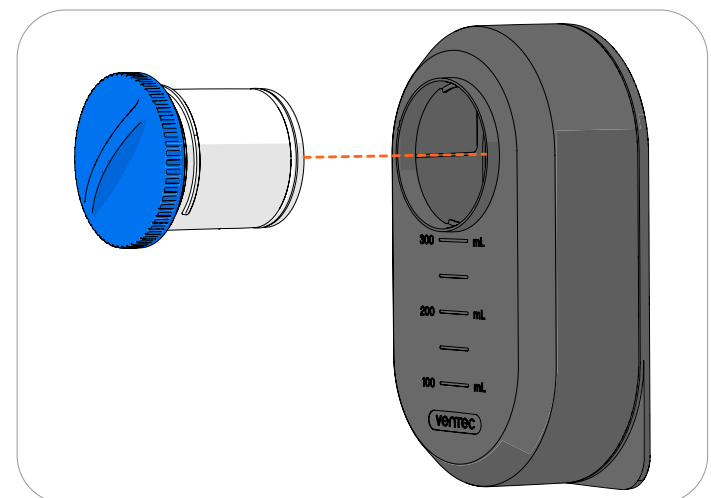
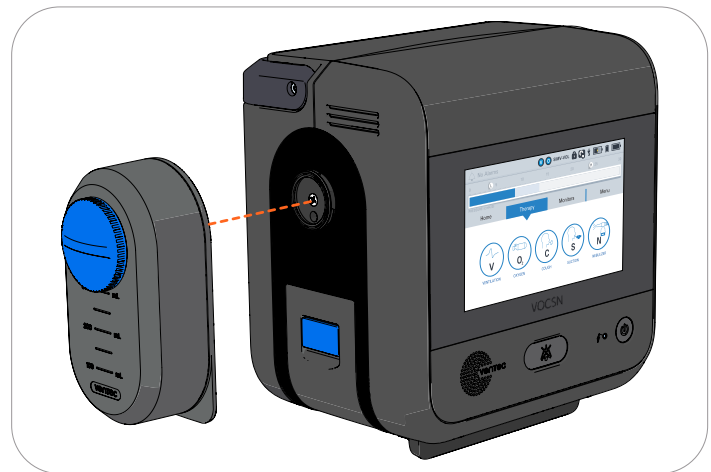
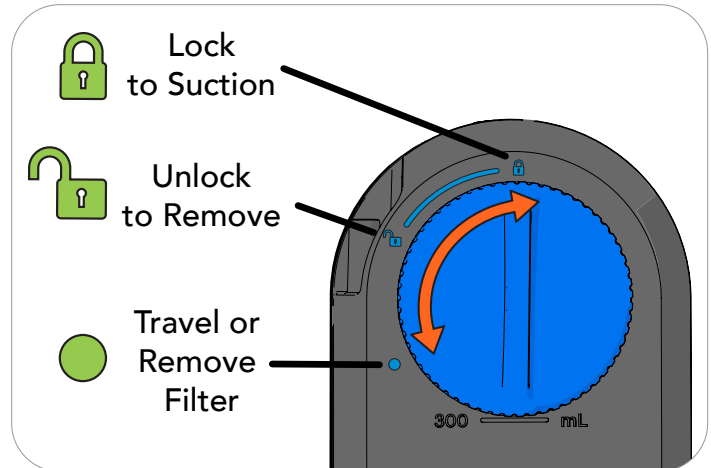

Replacing the Power Supply

For a replacement power supply, contact Ventec Life Systems service representative. To replace the VOCSN AC adapter, unplug the AC adapter from the outlet and the VOCSN, and dispose of it in accordance with local regulations.

Connect the new AC adapter to the VOCSN and power outlet. For more information, see *"Power Setup"* on page 22.

Replacing the Ventec One-Circuit or Ventec Humidifier Bypass

Ventec One-Circuits are intended for single-patient use. Replace both the Ventec One-Circuit and Ventec Humidifier Bypass (if used) between patient uses, or whenever they become contaminated. The bypass should be replaced at the same time as the circuit.

The patient condition, damage to the Ventec One-Circuit, or contamination may be conditions that require Ventec One-Circuit replacement. Follow your healthcare institution's protocol for Ventec One-Circuit and Ventec Humidifier Bypass replacement criteria.

NOTE: Replacement parts are available from Ventec Life Systems. Contact your Ventec Life Systems representative to order a replacement Ventec One-Circuit or Ventec Humidifier Bypass. See *"Accessories"* on page 204 for a list of accessories available from Ventec Life Systems.

To replace a Ventec One-Circuit:

- 1 Provide an alternate means of ventilation, if required, and power off VOCSN.
- 2 Disconnect the Ventec One-Circuit or Ventec Humidifier Bypass from VOCSN. Disconnect all Ventec One-Circuit components.
- 3 Connect a new Ventec One-Circuit or Ventec Humidifier Bypass, and reconnect all components. See *Chapter 2, "Setup"* for instructions.
- 4 Power on VOCSN by pressing the On/Off button.
- 5 Run a Pre-Use test. See *"Running the Pre-Use Test"* on page 50 for more information.
- 6 Resume VOCSN Ventilation therapy.

Replacing Ventec One-Circuit Components

Follow your healthcare institution’s protocol for cleaning and replacement of Ventec One-Circuit components, as well as any instructions and recommendations for replacement provided by Ventec One-Circuit accessory manufacturers. Inspect all accessories including your humidifier or HME, nebulizer, external bacterial filter, and any other accessories for signs of damage. Discontinue use and replace any damaged Ventec One-Circuit accessories immediately.

NOTE: Ventec Life Systems recommends running a Pre-Use Test each time the Ventec One-Circuit configuration is modified. See *“Running the Pre-Use Test”* on page 50 for instructions.

Replacing the Nebulizer Filter

The VOCSN Nebulizer Filter is intended for single-patient use. Replace the nebulizer filter between patient uses, whenever it becomes soiled or damaged, or every 30 days (at a minimum). Follow your healthcare institution’s protocol for replacement criteria.

Replacing the External Bacterial Filter

The external bacterial filter is intended for single-patient use. Replace the external bacterial filter between patient uses, whenever it becomes soiled or damaged, or every 30 days (at a minimum). Follow your healthcare institution’s protocol for replacement criteria.

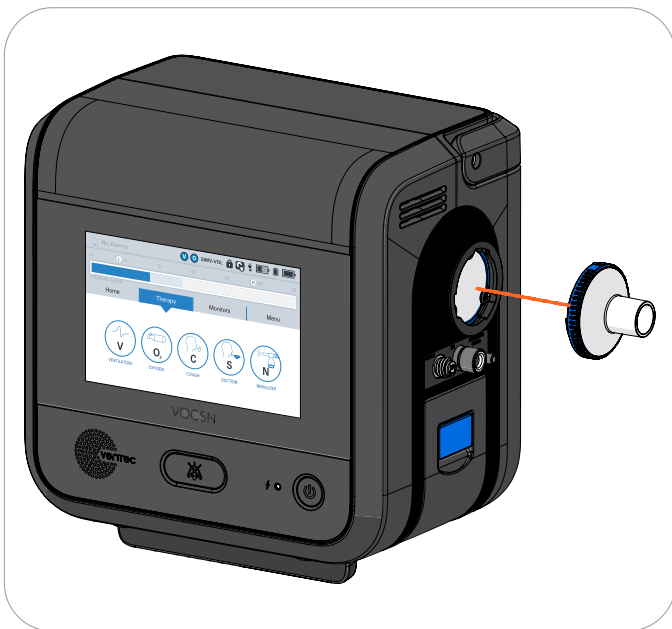

Replacing the Internal Bacterial Filter

Replace the VOCSN internal bacterial filter whenever it may have become contaminated or the external bacterial filter is compromised.

NOTE: It may be necessary to replace the internal bacterial filter more often in some environments, such as those with cigarette smoke. VOCSN may fail its Pre-Use Test if the internal bacterial filter becomes heavily contaminated.

To remove and replace the Internal Bacterial Filter:

- 1 If needed, provide the patient with backup ventilation, and then remove the patient circuit and the external bacterial filter. See *"Replacing the External Bacterial Filter"* on page 165 for detailed instructions.
- 2 Using a #1 Phillips torque driver, remove the 3 screws in the mounting ring, which holds the filter in place. Then, remove the mounting ring.
- 3 Pull the Internal Bacterial Filter out, and replace it with a new one.
- 4 Replace the mounting ring and 3 screws, using a #1 Phillips torque driver calibrated to 3 in-lb (48 in-oz).

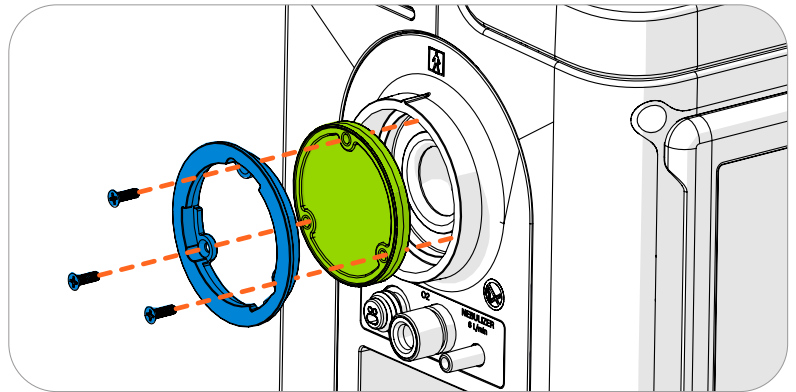

CAUTION: Do not let anything enter the cavity behind the filter during the replacement process. Do not re-install the Internal Bacterial Filter screws without using a calibrated torque driver. Foreign material inside VOCSN or using too much torque on these screws may severely damage VOCSN.

- 5 Confirm the Internal Bacterial Filter was replaced correctly by performing the *"Ventilation and Oxygen Testing Procedures"* on page 139.

Recommended Maintenance Schedule

Perform VOCSN maintenance tasks in the following table at the recommended intervals.

NOTE: VOCSN includes an internal clock that monitors the time elapsed since the device was last serviced. The Sys. PM Due In monitor counts down to the next time periodic maintenance should be performed on VOCSN by an authorized service representative. Contact your VOCSN representative when the Maintenance Due or Service Concentrator Soon alarm activates.

NOTE: A service manual containing detailed technical information required by authorized service technicians to repair and replace serviceable parts of VOCSN is available from Ventec Life Systems on request. Only authorized service technicians should repair VOCSN.

Periodicity	Maintenance	May be performed by...
Before storage	Fully charge removable and internal batteries. With software versions 4.11R and later, activate Battery Storage Mode by following the instructions in <i>"Battery Storage Mode"</i> on page 169.	Patient, Caregiver, or Clinician
Every 12 months (in Battery Storage Mode), or every 30 days (active batteries)	Fully charge removable and internal batteries.	Patient, Caregiver, or Clinician
Before each patient use	Run a Pre-Use Test. Fully charge removable and internal batteries. Perform Checkout Procedures. See <i>"Checkout Procedure"</i> on page 137 for instructions. Clean the exterior of VOCSN, See <i>"Cleaning VOCSN Exterior"</i> on page 161 for instructions.	Caregiver or Clinician
Every day during use	Inspect the Ventec Travel Suction Canister, if used. Replace the container if it is full. Inspect and clean the air and fan filters. Replace the filters as needed. Inspect the Nebulizer Filter. Replace the filter if it is damaged or contaminated. Inspect the VOCSN exterior, including all connection ports and connected components, for signs of damage.	Caregiver or Clinician
Every month during use	Test the VOCSN alarm system. See <i>"Ventilation Alarm Verification"</i> on page 141 for instructions. Test the VOCSN batteries and power cord. See <i>"Power Testing Procedures"</i> on page 138 for instructions. Replace the VOCSN Bacterial Filter and Nebulizer Filter.	Caregiver or Clinician
Every three months during use	Clean the exterior of VOCSN. See <i>"Cleaning VOCSN Exterior"</i> on page 161 for instructions.	Caregiver or Clinician
"Service Concentrator Soon" alarm	Contact Ventec Life Systems to have VOCSN serviced by a trained technician.	Caregiver or Clinician
Every two years, or every 10,000 hours	Contact Ventec Life Systems to have VOCSN serviced by a trained technician.	Caregiver or Clinician

Battery Care, Maintenance, and Replacement

The VOCSN removable and internal batteries are Lithium-ion. To maximize battery life, charge the VOCSN batteries before they drain completely. The batteries charge whenever VOCSN is plugged into an external source of power.

Battery icons in the status bar display a battery's charge status relative to its capacity (which diminishes over time). When plugged into external power for an extended period, these status bar indicators will always report a 100% charge, even when the absolute battery capacity has decreased with use and time.

The battery Absolute Charge status (shown on the My VOCSN screen) reports how the battery capacity is diminishing over time. Over time, the battery icons in the status bar will display a full (100%) charge, and the absolute charge status displayed on the My VOCSN screen will read <100%, even when VOCSN is plugged into external power for an extended period.

Battery replacement is recommended when the battery icons in the status bar show 100%, but the battery Absolute Charge status on the My VOCSN screen shows 50% or less. This means the battery has half (or less) of the charge capacity it did when new. Removable battery replacements are available from Ventec Life Systems. The internal battery must be replaced by Ventec Life Systems service personnel.

NOTE: Ensure the batteries are fully charged before storing VOCSN.

NOTE: The removable batteries are intended to charge while installed in VOCSN or the Removable Battery Quick Charger. Do not attempt to charge the VOCSN batteries while removed from the VOCSN or the charger.

NOTE: Use batteries from Ventec Life Systems. Do not use batteries from other manufacturers to power VOCSN.

WARNING: Do not damage the rechargeable Lithium-ion battery. A damaged battery may cause an explosion or fire, and may result in personal injury and/or property damage. To prevent injury or damage:

- Do not use or charge the battery if it appears to be damaged. Signs of damage include, but are not limited to, discoloration, warping, and leaking battery fluid.
- Do not expose the battery to fire, high temperature.
- Do not immerse the battery in water.
- Do not use or store the battery inside a vehicle during hot weather.
- Do not drop or puncture the battery.
- Do not open the battery or short-circuit its contacts.

WARNING: Avoid contact with the rechargeable lithium-ion battery if it appears to be leaking. Battery fluid is corrosive. Contact with battery fluid can result in personal injury and/or property damage. To prevent injury or damage:

- If the battery leaks, avoid contact with the battery fluid.
- If the battery fluid gets into your eyes, immediately rinse your eyes with clean water and seek medical attention. Do not rub your eyes.
- If battery fluid gets onto your skin or clothing, immediately use clean water to wash off the battery fluid.

Battery Storage Mode

VOCSN is shipped in Battery Storage Mode to preserve the charge of its three batteries. With software versions 4.11R and later, users can select the Activate Battery Storage Mode control in the Device Settings and place the fully charged internal battery and both removable, rechargeable batteries back into this power-saving storage mode. This allows VOCSN to remain in storage for 12 months at a time between recharging the batteries.

IMPORTANT NOTE: If Battery Storage mode is **not** used, all three VOCSN batteries should be fully charged every 30 days.

To activate Battery Storage Mode before putting VOCSN into storage:

- 1** Fully charge the internal and two removable, rechargeable batteries. The small indicator light next to the On/Off button will illuminate green when all three batteries are fully charged.
- 2** Press the **Menu** tab, and then select **Device Settings**.
- 3** Scroll down the to **Activate Battery Storage Mode** control. Press the control name to highlight it, and then select **Edit**.
- 4** An instructional screen will appear. Follow all on-screen instructions carefully. Ensure both removable, rechargeable batteries are connected, and that external power is disconnected.
- 5** Press and hold the **On/Off** button for 3 seconds (but less than 10 seconds).
- 6** Press **OK** in the pop-up. VOCSN will power down, and the Inop alarm will sound to confirm Battery Storage Mode was successfully activated.
- 7** Press the **On/Off** button to clear the alarm.

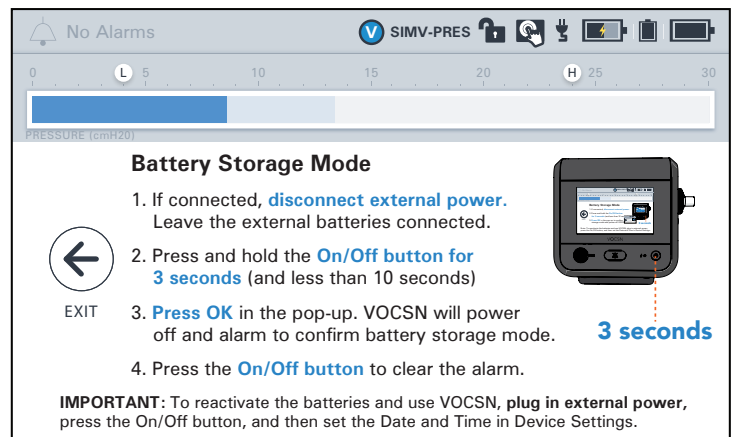

To reactivate the three batteries and use VOCSN:

- 1** Leave the removable, rechargeable batteries connected.
- 2** Connect external power. VOCSN will immediately power on and sound the Inop alarm to confirm the batteries are active and no longer in storage mode.
- 3** Press the **On/Off** button to clear the alarm.
- 4** Press the **Menu** tab, and then select **Device Settings**.
- 5** Set the **Date** and **Time** controls.
- 6** Follow your healthcare institution's protocol to begin using VOCSN.

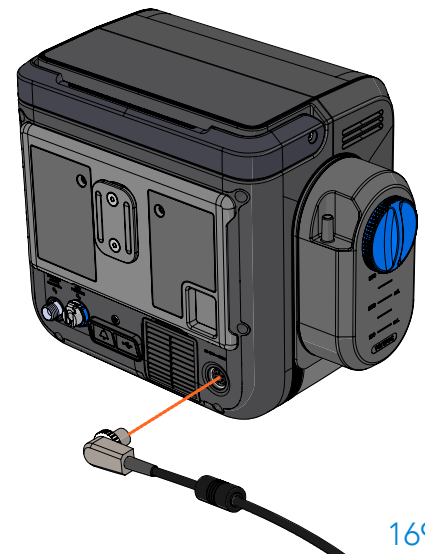

Software Updates

Ventec Life Systems periodically releases VOCSN software updates, which may include new features and extended functionality. Software updates occur in the field as needed, or when VOCSN is serviced. Contact Ventec Life Systems for additional information about software releases and upgrades.

This Clinical and Technical manual describes the features available with the latest version of software. VOCSN devices operating using a previous revision may not include all features and controls described in this manual. The following table provides a high-level overview of the major features released with each software version (listed newest to oldest).

SW Version	Features
5.01R	<ul style="list-style-type: none"> • Improved triggering performance. • New Peak Insp Flow & Peak Exh Flow monitors. • Updated Volume Targeted modes by decoupling Tidal Volume and Inspiratory Time. • Improved O2 Concentration alarm criteria. • Improved Service Concentrator Soon alarm criteria. • New O2 Tube Disconnect alarm. • New Media Bed Health monitor. • Improved FiO2 monitor responsiveness. • Improve life of battery by updating Battery Firmware on power down.
5.00R	<ul style="list-style-type: none"> • Introduced Quick View menu for faster access to commonly used therapies and features. • Support for Multi-View Streaming (including new Mark Event button). • High Flow therapy improvements, including: <ul style="list-style-type: none"> • New "Low Flow" alarm during High Flow therapy. • Minimum flow during High Flow raised to 5 L/min. This also means that if Nebulizer is active during High Flow therapy, the minimum flow is 11 L/min. • Added pop-up alert when the Circuit Type is set to Valveless during High Flow therapy. • Updated Maintenance Due and Service Concentrator Soon alarms so that they recur every 32 hours (instead of 8 hours) when cleared. • V+O+C+S+N factory default Oxygen Source setting changed to Internal O2 Concentrator.
4.13R	<ul style="list-style-type: none"> • Updates to aid in VOCSN manufacturing (no customer-facing changes).
4.12R	<ul style="list-style-type: none"> • Introduced support for VCSNPro configuration. • Reduced sensitivity of Check Patient Circuit alarm. • Removed O2 tube check from Pre-Use Test when High Flow is On.
4.11R	<ul style="list-style-type: none"> • Introduced Battery Storage Mode.
4.10R	<ul style="list-style-type: none"> • Updates to aid in VOCSN manufacturing (no customer-facing changes).
4.09R	<ul style="list-style-type: none"> • Introduced Inspiratory Hold feature.
4.08R	<ul style="list-style-type: none"> • Added support for V+Pro Emergency configuration.
4.07R	<ul style="list-style-type: none"> • Added support for V+Pro configuration.
4.06R	<ul style="list-style-type: none"> • Introduced Multi-View support. • Added Leak+ performance for compatible devices. • Released three new ventilation modes to replace "Volume Targeted" control: Vol. Targeted-PS, Vol. Targeted-PC, and Vol. Targeted-SIMV.
4.05R	<ul style="list-style-type: none"> • Corrected occasional black screen on startup.

<p>4.04R</p>	<ul style="list-style-type: none"> • Protection against potential hardware issues that may arise in rare cases. • Increased battery icon resolution to show greater charge status detail. • Optimized graphics memory usage to improve touchscreen performance. • Minimum PEEP setting for Valveless circuits increased from 0 to 4 cmH₂O.
<p>4.03R</p>	<ul style="list-style-type: none"> • External Nebulizer Compensation feature introduced. • New Volume Targeted controls for increased patient comfort: Pres. Minimum and Pres. Adj. Rate. • Flow Trigger control resolution and minimum setting changed to 0.5 L/min. • “Maintenance Required” alarm changed to “Maintenance Due” and now only occurs when the Sys. PM Due In monitor falls below 0. A new “Service Concentrator Soon” alarm activates when service should be scheduled for the internal O₂ Concentrator. • “O₂ Concentrator Usage” monitor modified to display total hours oxygen therapy has been active, rather than incrementing only when the concentrator activates to fill the oxygen tank. (Concentrator activation is intermittent during normal oxygen delivery, and is counted and displayed using the new “VP₂A Usage” monitor).
<p>4.02R</p>	<ul style="list-style-type: none"> • Add time to the Nebulizer while running. • Pre-Use Test timeout after 20 seconds.
<p>4.01.06R</p>	<ul style="list-style-type: none"> • Nebulizer resumes after Cough.
<p>4.01.03R</p>	<ul style="list-style-type: none"> • O₂ Flush feature. • Touchscreen lock/unlock.

Locating the VOCSN Software Version

To view which version of software is installed on VOCSN:

- 1** Press the [Menu](#) tab.
- 2** Press the [MY VOCSN](#) button.
- 3** Scroll past the [SOFTWARE](#) banner and locate the line item for [UIM SW VERSION](#).



NOTE: In VOCSN documentation, software after 4.02 is referred to by the first digit and decimal. For instance, version 4.03.02R is known as 4.03R.

Environmental Considerations

To minimize the environmental impact of VOCSN use during its service life, follow all setup, operation, cleaning, and maintenance instructions and recommendations provided in this manual.

VOCSN contains lithium-ion (Li-Ion) batteries and other potentially biohazardous materials. Dispose of VOCSN and any potentially biohazardous parts or accessories in accordance with local regulations.

Follow your local governing ordinances for disposal and recycling of the Li-ion Battery Pack and its accessories. If Waste Electrical and Electronic Equipment (WEEE) directive regulations apply, do not dispose of the battery in unsorted municipal waste. Within Europe, contact the EU Authorized Representative for disposal instructions. The battery contains Lithium Ion cells and should be recycled. The battery must not be incinerated.

Shipping Considerations





To ensure the device is not damaged during shipment, and that the shipment meets all applicable regulations, always use packaging approved by Ventec Life Systems when shipping VOCSN. Contact Ventec Life Systems with questions, and to obtain packaging materials.

Do not ship batteries with signs of mechanical damage by aircraft. Damaged batteries should be discarded or recycled in accordance with local regulations.

Glossary





Glossary of Symbols

The following symbols appear on the exterior of VOCSN.

Symbol	Description	Title and Reference
	Consult accompanying product instructions	Refer to Instruction Manual/Booklet ISO 7010 Symbol M002
	Do not operate near open flame	No Open Flame ISO 7010 Symbol P003
	Do not smoke near equipment	No Smoking ISO 7010 Symbol P002
	Do not use the VOCSN within magnetic resonance (MR) environments	MR Unsafe ASTM F2503 Table 2
	USB Port	USB 2.0 Port USB Implementers Forum, Inc.













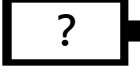

Symbol	Description	Title and Reference
	Indicates the device serial number	Serial Number ISO 7000 Symbol 2498
	Device identifier	Catalogue Number ISO 7000 Symbol 2493
	Authorized European Representative	Authorized European Representative ISO15223-1 Clause 5.1.2
	Environmental requirements for storage and shipping	Temperature Limitation ISO 7000 Symbol 0632
	Dispose of equipment in accordance with requirements of the Waste in Electrical and Electronic Equipment Directive (2002/96/EC)	Recycle: Electronic Equipment EN 50419
	Lithium-Ion battery. Recycle in accordance with local regulations	Li-Ion Battery Recyclable Symbol ISO 7000 Symbol 1135
	On/Off button	Standby IEC 60417 Symbol 5009
	Alarm Silence button	Bell Cancel (Audio Pause) IEC 60417 Symbol 5576-2











Symbol	Description	Title and Reference
	Remote alarm port	Bell IEC 60417 Symbol 5013
	Date of manufacture	Date of Manufacture ISO 7000 Symbol 2497
	Date of Expiry (Expiration). Do not use device after this date.	Use by Date ISO 7000 Symbol 2607
	Name and address of device manufacturer	Manufacturer ISO 7000 Symbol 3082
	Caution	Caution ISO 7000 Symbol 0434A
	Compliant with RoHS (Restriction of Hazardous Substances) Directive	RoHS Compliant RoHS Directive 2002/95/EC
	The VOCSN isolates the patient from live voltage in the device	Type BF Applied Part IEC 60417 Symbol 5333
	Indicates external power and battery charging status	External Power Indicator Light Industry standard

Symbol	Description	Title and Reference
IP32	The IP32 rating indicates that the VOCSN enclosure protects it against ingress from wires and tools >2.5mm, and dripping water	Degree of Ingress Protection Provided by Enclosure IEC 60601-1, Table D.3, Symbol 2
Rx ONLY	Federal law restricts this device to sale by or on the order of a physician	Prescription Only 21 CFR 801.15(c)(1)(i)F
	Indicates that the VOCSN has been certified by TUV for safety according to Canadian and US regulations	TUV Certification Mark TUV SUD
	Compliant with the requirements of applicable European Union Directives	CE Mark MDD Directive 93/42/EEC
	Twist the suction canister connection knob to this position to secure it to VOCSN	N/A
	Twist the suction canister connection knob to this position to remove it from or reattach it to VOCSN	N/A
	Twist the suction canister connection knob to this position to remove the suction canister filter cartridge	N/A
	VOCSN that include an airplane symbol on the back label are compliant with the regulations for device use on board aircraft	N/A

Glossary of Indicators

The following icons and indicators may appear on the VOCSN touchscreen:

Indicator	Description	Indicator	Description
	External battery is fully charged		External battery is more than half depleted
	External battery is charging		External battery is empty or not installed in VOCSN
	External battery is not installed in VOCSN		External battery status is unknown
	Internal battery is fully charged		Internal battery is half depleted
	Internal battery is charging		Internal battery is low
	Internal battery is critically low		Internal battery is not installed or its status is unknown.
	This icon appears when external power is connected to VOCSN		Toggle. press or slide to toggle between two selections such as On/Off
	Alarm, Low		Alarm, High

Indicator	Description	Indicator	Description
	VOCSN is locked; Clinician Access Passcode is required to access locked VOCSN controls		VOCSN is unlocked; Clinician Access Passcode has been entered or is not required, and all VOCSN controls are configurable
	Alarm indicator. This icon will appear light gray if there are no alarms, and dark gray if alarms have activated recently. Press the icon to navigate to the Alarm Log.		Alarm is silenced. Press the icon to navigate to the Alarm Log.
	Touchscreen is unlocked. Press and hold icon for 3 seconds to lock the VOCSN touchscreen.		Touchscreen is locked. Press and hold icon for 3 seconds to unlock the VOCSN touchscreen.
	The Ventilation icon with a blue background appears in the status bar when VOCSN is delivering Ventilation therapy		The Ventilation icon with a white background appears in the status bar when the Leak+ feature is available, enabling High Flow therapy and Leak Compensation for patient circuit leaks up to 175 L/min at 20 cmH2O.
	This icon appears in the status bar when VOCSN is delivering Oxygen therapy		This icon appears in the status bar when VOCSN is delivering Touch Button Cough therapy
	This icon appears in the status bar when VOCSN is delivering Suction therapy		This icon appears in the status bar when VOCSN is delivering Nebulizer therapy
	This icon appears when a breath is patient-triggered		

Glossary of Terms

Term	Definition
AC	Alternating Current. VOCSN can be connected to external, continuous sources of AC power, such as a wall outlet.
Apnea	The temporary cessation of a patient's ability to initiate breaths on their own.
Assist breath	A breath that is initiated by patient effort and cycled by VOCSN.
BPM	Breaths Per Minute.
BTPS	Body Temperature and Pressure Saturated.
DC	Direct Current. VOCSN can be connected to external sources of DC power, such as wheelchair outlets.
EPAP	Expiratory Positive Airway Pressure.
I:E Ratio	The ratio of inspiratory time to expiratory time.
IPAP	Inspiratory Positive Airway Pressure.
L/min	Liters per minute.
Mandatory breath	A breath that is initiated and cycled by VOCSN.
MAP	Mean Airway Pressure. The MAP is the average patient airway pressure as measured over one full breath cycle.
PEEP	Positive End Expiratory Pressure.
PIP	Peak Inspiratory Pressure.
Sigh	The Sigh control can be set to deliver a breath at 150% the normal breath volume every 100th mandatory or assist breath.
SIMV	Synchronous Intermittent Mandatory Ventilation. Depending on the frequency of patient effort, mandatory, assist, and spontaneous breaths will be delivered to the patient as either volume or pressure breaths (depending on the ventilation mode selected).
Spontaneous breath	A breath that is initiated and cycled by patient effort.
Tidal Volume	The total volume of gas entering the lungs during one breath.
V _{te}	Exhaled Tidal Volume. The total volume of gas leaving the lungs during one breath.
ATPD	Ambient Temperature and Pressure, Dry.
PSIG	Pounds per square inch, gauge.

Troubleshooting

Some issues with VOCSN can be resolved quickly by following the steps described in this chapter. Others may require service from an authorized Ventec Life Systems service technician. In case of VOCSN malfunction, the clinician or caregiver must be able to provide an alternative means of ventilation promptly when necessary.

Troubleshooting Alarms

The VOCSN operator must be capable of responding to alarm conditions and promptly performing the necessary corrective actions. See *“Alarms” on page 104* for information on each alarm condition, including the recommended actions associated with each.

Alarm	Recommended Troubleshooting Actions
<p>Apnea activates when VOCSN has not delivered assist or spontaneous breaths (or coughs) for the set Apnea alarm duration.</p>	<ul style="list-style-type: none"> • Ensure the Apnea alarm is set appropriately given the patient’s Breath Rate and spontaneous rate. • Ensure the Flow Trigger control is set appropriately. • Check patient triggered icon and waveforms to determine if patient is attempting to initiate breaths. (If the patient is not initiating breaths, the alarm is working as intended.) • Check for problems with patient triggering such as low drive due to medication, or copious secretions, or excessive mask or cuff leak. • For Active circuits, turn on Leak Compensation if needed. • If the problem persists, replace the circuit.

Alarm	Recommended Troubleshooting Actions
<p>Battery Use activates whenever VOCSN switches from external power to battery power, or from any power source (including removable battery) to internal battery power.</p> <p>Internal Battery Low activates when VOCSN internal battery charge status falls below 50%.</p> <p>Internal Battery Critically Low activates when the internal battery is disconnected, faulty, or when the battery is critically low (charged to less than 33% its capacity).</p>	<p>When using battery power, battery alarms are normal.</p> <ul style="list-style-type: none"> • Monitor battery charge status, and connect an external source of power when available. • To clear the Battery Use alarm while using removable, rechargeable battery power, navigate to the Alarm Log and select "Clear List" twice. <p>When using AC power, check to ensure there's a power connection symbol in the status bar. If the power symbol is present, VOCSN is powered.</p> <ul style="list-style-type: none"> • Clear the alarm by navigating to the Alarm Log and selecting "Clear List" twice. <p>If there is no power connection symbol in the status bar:</p> <ul style="list-style-type: none"> • If the green light on the power adapter block is illuminated, check that all power adapter cabling is securely connected, and that the cable is securely connected to the power port in the back of VOCSN. • If the green light on the power adapter block is off (not illuminated): <ul style="list-style-type: none"> • Ensure power adapter is plugged into the wall outlet. • Ensure the AC power cord is securely plugged into the power adapter block. • Plug something else into the same wall outlet to ensure it is powered. • If the problem persists, replace the AC power adapter.
<p>Check O2 Source activates when a connected source of external low-pressure oxygen is used and the monitored FiO2 falls below 24%.</p>	<ul style="list-style-type: none"> • Check to ensure the low-pressure oxygen source is connected. • Make sure the low-pressure oxygen source is turned on and is producing oxygen, or is not depleted.
<p>Check Patient Circuit activates when VOCSN detects an inadequate leak in a passive or valveless circuit, or an error in the flow sensor of an active circuit.</p>	<ul style="list-style-type: none"> • Run a Pre-Use Test. This step insures the selected circuit is correct. • For Passive circuits, check the VOCSN Leak monitor. If needed, locate and resolve any unintentional leaks in the patient circuit (or around the patient interface), and ensure the exhalation valve is not obstructed (for example, by crystallized medications in the exhalation valve). • For Active circuits, make sure the flow sensor (multilumen) tubing is securely connected to VOCSN and the active exhalation valve. • If using a nebulizer (particularly with sticky medications), install a filter (HMEF or bacterial filter) between the nebulizer and the patient circuit exhalation valve. • If using Cough therapy, and patient secretions are entering the patient circuit, install a filter (such as an HMEF), and/or use a 6" length of corrugated circuit tubing between the patient interface and the patient circuit exhalation valve during Cough to catch secretions. • For heated circuits, ensure there is no water accumulation in the tubing or valve. • If the problem persists, replace the patient circuit.

Alarm	Recommended Troubleshooting Actions
<p>High Breath Rate activates when the monitored breath rate is higher than the set High Breath Rate alarm limit.</p>	<ul style="list-style-type: none"> • Ensure the High Breath Rate alarm is set above the patient Breath Rate plus spontaneous rate. • Check for patient secretions, and use Suction therapy to clear them if needed. • Empty any excess condensation in the patient circuit. • Check the VOCSN Leak monitor. If it is high, locate and resolve any unintentional leaks in the patient circuit (and around the patient interface). • If VOCSN is auto-triggering, adjust the Flow Trigger setting if needed.
<p>High FiO2 activates when the monitored FiO2 percentage is higher than the set High FiO2 alarm limit.</p>	<ul style="list-style-type: none"> • Check to ensure there are no unintended sources of gas or oxygen connected to VOCSN or the patient circuit.
<p>High Minute Volume activates when the monitored Minute Volume is larger than the set High Minute Volume alarm limit.</p>	<ul style="list-style-type: none"> • Ensure the alarm is set appropriately for the patient Breath Rate plus spontaneous rate. • Check to see if the monitored Breath Rate is high. If so: <ul style="list-style-type: none"> • Check for auto-triggering and adjust the Flow Trigger control setting if needed. • If you are using an active Ventec One-Circuit and humidifier, clear any condensation from the active exhalation valve.
<p>High PEEP (or High EPAP in Bi-Level Mode) activates when the monitored PEEP is greater than PEEP plus the set High PEEP alarm limit.</p>	<ul style="list-style-type: none"> • If using an Active patient circuit, ensure the multilumen tube is tightly connected to VOCSN and the exhalation valve. • Note that if the alarm occurs while the patient is breath stacking, it is working as intended. • Check for auto-triggering and adjust the Flow Trigger control setting if needed. • If the problem persists, replace the patient circuit.
<p>High Pressure activates when the monitored Airway Pressure exceeds the set High Pressure alarm limit for more than the number of consecutive breaths set with the High Pressure Delay control.</p>	<ul style="list-style-type: none"> • Ensure the High Pressure alarm is set appropriately for the patient as their condition changes (for example, through sneezes, coughs, and/or yawns). • Check for blockages or obstructions in the circuit and patient airway. (For example, saturated or clogged HME or bacterial filters, in-line suction catheters, or patient secretions during volume ventilation.) • If the problem persists, replace the patient circuit.

Alarm	Recommended Troubleshooting Actions
<p>Inop activates when VOCSN experiences a loss of power without available battery backup power, when the battery depletes and is the only available source of power, or when a software or hardware failure renders VOCSN unable to safely deliver therapy and/or monitor the patient.</p>	<ul style="list-style-type: none"> • Immediately provide the patient with an alternate source of ventilation. • Press the On/Off button again to restart VOCSN. • If the device remains inoperative, contact your local Ventec Life Systems representative for service.
<p>Internal Battery Critically Low</p>	<ul style="list-style-type: none"> • See "Battery Use" on page 1.
<p>Internal Battery Low</p>	<ul style="list-style-type: none"> • See "Battery Use" on page 1.
<p>Low Breath Rate activates when the monitored Breath Rate is less than the set Low Breath Rate alarm limit.</p>	<ul style="list-style-type: none"> • Ensure the alarm limit is set appropriately for the patient Breath rate plus spontaneous rate. • Check patient and waveforms to determine if patient is attempting to initiate breaths. (If the patient is not initiating breaths, the alarm is working as intended.) • Check to ensure all connected components are clean and not clogged (such as filters and HMEs). • Ensure the Flow Trigger control is set appropriately. • For Active circuits, turn on Leak Compensation if needed. • If the problem persists, replace the patient circuit.
<p>Low FiO2 activates when the monitored FiO2 falls below the set Low FiO2 alarm limit.</p>	<ul style="list-style-type: none"> • Ensure the Low FiO2 alarm setting is appropriate for the delivered FiO2. • Check to ensure the high-pressure oxygen source is connected, and is not depleted. • Make sure the high-pressure oxygen source is turned on, and is delivering oxygen. • Verify the O2 Low-Pressure Inlet adapter is not installed (if low-pressure oxygen is not in use).
<p>Low Inspiratory Pressure activates when the monitored Peak Inspiratory Pressure falls below the set Low Inspiratory Pressure alarm limit.</p>	<ul style="list-style-type: none"> • Ensure the Low Inspiratory Pressure alarm is set below the patient peak inspiratory pressure, taking into account changes in airway resistance and/or lung recruitment. • Check the VOCSN Leak monitor. If it is high, locate and resolve any unintentional leaks in the patient circuit (and around the patient interface). • If the problem persists, replace the patient circuit.

Alarm	Recommended Troubleshooting Actions
<p>Low Minute Volume activates when the monitored Minute Volume falls below the set Low Minute Volume alarm limit.</p>	<ul style="list-style-type: none"> • Ensure the Low Minute Volume alarm is set appropriately, taking into account changes in patient breathing habits at night. • Check the VOCSN Leak monitor. If it is high, locate and resolve any unintentional leaks in the patient circuit (and around the patient interface). If using a trach tube, ensure the cuff is properly inflated. • During pressure-control ventilation, check the patient for reduced lung compliance or airway blockages.
<p>Low PEEP (or Low EPAP in Bi-Level Mode) activates when the monitored PEEP falls 5 cmH₂O below the set PEEP control for 3 consecutive breaths.</p>	<ul style="list-style-type: none"> • Check the VOCSN Leak monitor. If it is high, locate and resolve any unintentional leaks in the patient circuit (and around the patient interface). • Run a Pre-Use Test. • If the alarm continues, replace the patient circuit.
<p>Maintenance Due activates when the Sys. PM Due In monitor falls below 0, indicating that VOCSN is due for maintenance. This alarm can be reset for up to 32 hours by clearing the alarm.</p>	<ul style="list-style-type: none"> • When convenient, contact your local Ventec Life Systems representative to schedule service. (Note that this alarm will activate every 32 hours until service is completed.)
<p>O₂ Concentration activates after five minutes or more (depending on VOCSN configuration settings) when the internal O₂ Concentrator produces less than 82% oxygen, or less than 80% of the target pulse dose volume. It will also activate if there is a fault with the internal oxygen sensor that measures gas created by the internal O₂ Concentrator, or if the monitored oxygen tank pressure is less than 4 PSI when using an external source of high-pressure oxygen.</p>	<ul style="list-style-type: none"> • Run a Pre-Use Test. • If using the internal O₂ Concentrator, ensure there is adequate airflow around the device. • If using an external source of high-pressure oxygen, check to make sure it is connected and is not depleted. • If using a patient circuit with O₂ tube: <ul style="list-style-type: none"> • Ensure the O₂ tube is firmly connected. (Note that it may take up to 1 hour for oxygen alarms to resolve after fixing an issue with the O₂ tube connection.) • Check the O₂ tube for blockages • If the problem persists, replace the patient circuit.
<p>Patient Circuit Disconnect activates when VOCSN detects a large leak in an active, passive, or valveless Ventec One-Circuit. (See below for alarm behavior during High Flow therapy.)</p>	<ul style="list-style-type: none"> • Check the VOCSN Leak monitor. If it is high, locate and resolve any unintentional leaks in the patient circuit (and around the patient interface). • Run a Pre-Use Test and ensure the Circuit Type control matches the type of circuit connected to VOCSN. • If the problem persists, replace the patient circuit.

Alarm	Recommended Troubleshooting Actions
<p>Patient Circuit Disconnect (during High Flow therapy) activates when no patient breathing is detected for 20 seconds.</p>	<ul style="list-style-type: none"> • Ensure the high flow nasal cannula (or other interface) is properly fitted to the patient. • If the problem persists, replace the high flow nasal cannula.
<p>Service Concentrator Soon activates when the VOCSN O2 Concentrator maintenance should be scheduled. This alarm can be reset for up to 32 hours by clearing the alarm.</p>	<ul style="list-style-type: none"> • When convenient, contact your local Ventec Life Systems representative to schedule service. (Note that this alarm will activate every 32 hours until service is completed or internal O2 concentrator is turned off.)
<p>System Fault activates if VOCSN detects any one of multiple system fault conditions.</p>	<ul style="list-style-type: none"> • Use the Event Log to determine the System Fault number, then see <i>"System Fault Detection Criteria and Recommended Action"</i> on page 223 and then take the corresponding action.
<p>Very Low FiO2 activates when the monitored FiO2 is less than 18%.</p>	<ul style="list-style-type: none"> • Ensure there the VOCSN air inlets are not blocked, and that there is adequate air flow around the device. • Remove any oxygen sources connected to VOCSN or the patient circuit. <ul style="list-style-type: none"> • If the Very Low FiO2 alarm resolves, troubleshoot problems with the oxygen source. • If the Very Low FiO2 persists there may be a problem with the VOCSN oxygen sensor. Contact your local Ventec Life Systems representative for service.

Device Troubleshooting

Problem	Cause	Solution
VOCSN enclosure is abnormally warm	Air and/or fan filter is clogged	Clean and replace the air and fan filter. If the filters appear damaged, replace them
VOCSN will not power on	The internal and removable batteries are fully discharged	Plug VOCSN into a wall outlet. Ensure the wall outlet is functional and not controlled by a switch
	VOCSN requires service	Contact Ventec Life Systems for service
VOCSN will not power off	Touchscreen is not responsive	Press and hold the power button for more than 10 seconds
Batteries are not charging	VOCSN is operating at a temperature outside its environmental specifications, or the batteries are overheated	Verify that VOCSN is not close to a heat source. Move VOCSN to a cooler location if required
	Fan filter is clogged, causing VOCSN to overheat	Clean the fan filter
Device performance changes	Electrical interference	Move VOCSN away from any potential sources of electromagnetic interference (EMI) including MRI equipment, medical imaging systems, security systems, appliances, wireless communications equipment (such as cellular phones), computers, and televisions
	VOCSN requires a restart	Press the On/Off button and power off VOCSN. Press the On/Off button again to restart VOCSN
	VOCSN requires service	Contact Ventec Life Systems for service

Ventilation and Cough Troubleshooting

Problem	Cause	Solution
Abnormally warm gas is flowing through the Ventec One-Circuit	Air filter is clogged	Clean and replace the air filter. If the air filter appears damaged, replace it with a new one
	VOCSN is not properly ventilated	Move VOCSN away from cluttered areas, bedding, curtains, or anything else that could impede air flow around the device
	VOCSN is too close to a heat source	Move VOCSN out of direct sunlight and away from any other sources of heat
	VOCSN requires service	Contact Ventec Life Systems for service.
Patient tubing and flow sensor lines contain condensation	Use of a humidifier requires water management	Use a Ventec One-Circuit with heated wire
Vte and Minute Volume monitors are high	Condensation in the active Ventec One-Circuit exhalation valve	Remove the condensation from the exhalation valve Adjust the humidification to prevent condensation from building up in the exhalation valve Replace the patient circuit.
Vte monitor is high	A test lung, ET tube, trach tube, or HME is connected directly to an active exhalation valve.	Connect a flex tube to the active exhalation valve.
High or Low Vte monitors, autocyling, and/or low delivered pressure.	Active Ventec One-Circuit multilumen tube is not fully connected to the VOCSN "Active" port.	Tighten the active valve multilumen tube connection. Check all three rubber tube connections on the active exhalation valve. Replace the patient circuit.
System Fault 3, high or low Vte monitors, and autocyling	Water from a humidifier is in the Active Ventec One-Circuit multilumen sense lines.	Replace the patient circuit.
VOCSN prompts user to run Pre-Use Test when switching between two Mouthpiece ventilation Presets	The Humidification control is not user editable, but is set to HME for one Preset, and Humidifier for the other preset	Change the Circuit Type control from Mouthpiece to Passive. If necessary, change the Humidification control from Humidifier to HME. Change the Circuit Type control back to Mouthpiece. Repeat the steps above for all Ventilation therapy Presets used to provide mouthpiece ventilation

Oxygen Troubleshooting

Problem	Cause	Solution
Low or no delivered oxygen from the internal O2 Concentrator	Operating at environmental conditions which are outside the specifications range.	Move VOCSN to a location within its environmental operating range and wait 15 minutes for the device to cool down or warm up. Restart the O2 Concentrator
	Loose oxygen tubing connection.	Check and tighten all oxygen tubing connections and the Ventec One-Circuit connection
	Oxygen tubing is cracked.	Replace the oxygen tubing
	The VOCSN has an internal leak.	Contact Ventec Life Systems for service
Low delivered FiO2 from an external high-pressure source.	An installed O2 Low-Pressure Inlet Adapter is leaking oxygen.	If installed, disconnect the O2 Low-Pressure Inlet Adapter.
	Large leak is lowering the delivered FiO2.	Reduce the amount of leak in the patient circuit Use additive low-pressure oxygen to raise the delivered FiO2.
VOCSN makes a hissing sound while high-pressure oxygen is connected	The external high-pressure oxygen source is not firmly connected to the VOCSN oxygen port.	Tighten the high-pressure oxygen hose connector
	The VOCSN has an internal leak.	Contact Ventec Life Systems for service
	Oxygen is seeping from the O2 Low Pressure Inlet Adapter.	Disconnect the O2 Low Pressure Inlet Adapter.
Patient desaturation	O2 monitoring equipment is not connected.	Ensure the O2 monitoring equipment is connected to the patient.
	O2 tube connection problem	Run a Pre-Use Test. Ensure the patient circuit O2 Tube is firmly connected. (Note that it may take up to 1 hour for oxygen alarms to resolve after fixing an issue with the O2 tube connection.)
	External source of oxygen is disconnected or depleted	Check to ensure that any external source of oxygen is properly connected, and that is not depleted.

Suction Troubleshooting

Problem	Cause	Solution
Low or no suction	Loose tubing connection	Check and tighten all tubing connections
	Suction tubing or canister is cracked	Replace the suction tubing or suction canister
	Ventec Travel Suction Canister is full	Replace the Ventec Travel Suction Canister
	Open port on external suction canister	Close any open ports on the external suction canister
High suction pressure while catheter is open or disconnected	Suction filter inside the Ventec Travel Suction Canister or External Suction Canister Adapter is clogged	Replace the Ventec Travel Suction Canister filter or External Suction Canister Adapter filter
Suction therapy will not start when selected	Ventec Travel Suction Canister is full	Replace the Ventec Travel Suction Canister

Nebulizer Troubleshooting

Problem	Cause	Solution
The Patient Circuit Disconnect alarm activates during Nebulizer therapy	Exhalation valve is blocked or disconnected	Remove any obstructions around or in the passive exhalation valve, and verify that it is connected to the Ventec One-Circuit correctly
	Incorrect flow for nebulizer manufacturer	Refer to the instructions for use provided by the nebulizer manufacturer

Multi-View Troubleshooting

Problem	Cause	Solution
Export stalls while writing to USB drive	USB drive is corrupt	Use a new USB 2.0 drive formatted to FAT32.

Patient Circuit Troubleshooting

Problem	Cause	Solution
Patient circuit performance	Obstructions in the patient circuit	Ensure connected patient circuit accessories (such as an HME or humidifier) are clean and not obstructed.
	Circuit Type control is not set correctly	Ensure that the Circuit Type control settings matches the circuit type connected to VOCSN, and run a Pre-Use Test.

Recalibrating Batteries

Over time, the VOCSN batteries (the removable, rechargeable batteries and/or the internal battery) may require recalibration to report their charge status correctly in the VOCSN status bar.

If the three relative state of charge icons in the VOCSN status bar do not report that the batteries are fully charged even after VOCSN has been plugged in for 24 hours or more, disconnect VOCSN from the patient and recalibrate the batteries by following these steps:

- 1** Plug VOCSN into external power and charge the batteries until the charge status LED on the front of the device turns green.
- 2** Unplug VOCSN from external power to begin draining the batteries.
- 3** Discharge all three batteries completely. VOCSN will alarm and shut down when no battery power remains.
- 4** Allow VOCSN to sit off and disconnected from external power for at least 5 hours.
- 5** Plug VOCSN into external power and charge the batteries uninterrupted until the charge status LED on the front of the device turns green for at least 30 minutes.

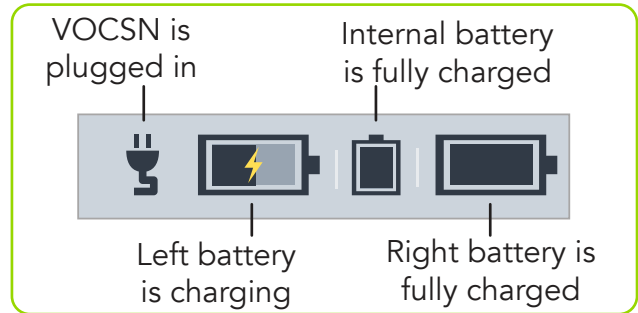

- Batteries are charging (orange)
- All batteries are fully charged (green)

NOTE: In addition to the relative state of charge status shown in the status bar, VOCSN reports the battery absolute state of charge. These values naturally decrease over time and are shown on the My VOCSN screen. When the absolute state of charge of a battery is <50% after charging for 24 hours, the battery should be replaced.

Technical Specifications

This chapter provides VOCSN technical specifications, including environmental requirements and the accuracy specifications of all controls and monitors.

NOTE: VOCSN will continue to meet its stated performance specifications when operating on battery power.

Physical

Physical Category	Specification
VOCSN	Dimensions: 10.25" wide, 11" high, 7.5" deep (26 cm wide, 27.9 cm high, 19.1 cm deep) Weight (with removable, rechargeable batteries installed) per configuration: <ul style="list-style-type: none"> • V+O+C+S+N+Pro: 18.3 lbs (8.3 kg) • V+O+C+S+N: 18.1 lbs (8.3 kg) • V+C+S+N+Pro: 17.8 lbs (8.1 kg) • V+C+Pro: 14 lbs (6.4 kg) • V+C: 12.5 lbs (5.7 kg) • V+Pro: 14.2 lbs (6.4 kg)
Rechargeable, removable batteries	Dimensions: 2.7" wide, 3.9" high, 2.2" deep (6.9 cm wide, 9.9 cm high, 5.5 cm deep) Weight: 1 lb 1 oz (484 g)

Environmental

NOTE: Unless otherwise specified, the following environmental specifications apply to all VOCSN components, controls, alarms, and monitors.

Environmental Category	Specification
Temperature and Relative Humidity	Operating: +5 °C to +40 °C; 15% to 90% relative humidity, non-condensing Storage and transport: -25 °C at any humidity to +70 °C at up to 90% relative humidity, non-condensing
Atmospheric Pressure	Operating: 700 to 1060 hPa Storage: 500 to 1100 hPa
Drop	Without protective case: 0.1 meters per IEC 60068-2-3
Ingress	IP32 per IEC 60529. Protected against dripping water and ingress of tools and thick wires
Shock	Storage: 15g per IEC 60068-2-27 Operating: 5g per IEC 60068-2-27
Vibration	Storage: 1.0 (m/s ²)/Hz per IEC 60068-2-64 Operating: 0.33 (m/s ²)/Hz per IEC 60068-2-64

Inputs and Outputs

Category	Specification
High-pressure O2 inlet	O2 DISS 1240 per CGA V-5 280 to 600 kPa (41 to 87 PSIG) Flow ≤200 L/min
Low-pressure O2 inlet	CPC MC1602 Flow ≤20 L/min
USB	USB 2.0, FAT32 Format
Nebulizer drive port	Complies with BS EN 13544-2
Ventec One-Circuit connection port	22mm male conical fitting per ISO 5356-1

External Power Requirements

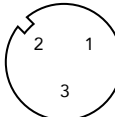
Category	Specification
AC power	<p>Sine AC mains waveform Rated Voltage: 100 to 240 VAC, 50 to 60 Hz Power for V+O+C+S+N(+Pro) configurations: ≤288 VA average, 420 VA peak Power for V+C(+Pro) configurations: ≤180 VA average, 240 VA peak</p>
DC power	<p>20.0 to 30.3 VDC, as measured at the connection to the device, through 0 to 350 W instantaneous loads</p> <p>Power for V+O+C+S+N(+Pro) configurations: ≤200 W average, 350 W peak</p> <p>Power for V+C(+Pro) configurations: ≤150 W average, 200 W peak</p> <p>Intended for connection to 24 V (27.2 VDC typical) batteries</p> <p>Female XLR3 connection port with the following pin configuration:</p>  <p>Pin 1 Signal: V+ Pin 2 Signal: RTN Pin 3 Signal: N/A (Unused by VOCSN)</p>

Removable, Rechargeable Batteries

Category	Specification
Operating time	<p>With ventilation at nominal settings and new batteries, approximate run times are: 6 hours on set of removable batteries when O2 Flow Equivalent is Off. 2 hours on set of removable batteries when O2 Flow Equivalent is set to 2.0 L/min. 1.5 hours on set of removable batteries when O2 Flow Equivalent is set to 6.0 L/min</p>
Capacity	5.8 Ahr
Voltage	14.4 VDC
Charging	Each removable battery requires 5 hours, typical, from full discharge to full charge. If fully discharged, charging time for the 2 removable batteries and Internal battery may require up to 14 hours.

Internal Rechargeable Battery

Category	Specification
Operating time	<p>With ventilation at nominal settings and a new battery, approximate run times are: 2 hours when O2 Flow Equivalent is Off. 0.75 hours when O2 Flow Equivalent is set to 2.0 L/min. 0.5 hours when O2 Flow Equivalent is set to 6.0 L/min</p>
Capacity	3.9 Ahr
Voltage	14.4 VDC
Charging	<p>If fully discharged, charging time for the 2 removable batteries and Internal battery may require up to 14 hours.</p> <div style="border: 1px solid black; border-radius: 10px; padding: 10px; margin-top: 10px;"> <p>NOTE: The power supply provided with VOCSN is >14 V. Charging time increases if a <14 V external power source is applied.</p> </div>

Expected Service Life and Intervals

Category	Expected service life
VOCSN	Expected Service Interval: 2 years or 10,000 hours of use (whichever is less) Expected Service Overhaul Interval: 30,000 hours of use Expected Service Life: With regular servicing, approximately 10 years.
Removable, rechargeable batteries	2 years or 500 complete charge/discharge cycles (whichever is less)

Audible Volume

Category	Volume
Ventilator	≤48 dBA at 1 meter
O2 Concentrator	≤52 dBA at 1 meter at maximum capacity
Suction Pump	≤70 dBA at 1 meter
Nebulizer	≤70 dBA at 1 meter
Inop alarm	65 to 90 dBA at 1 meter
Alarm at High volume	85 +15/-5 dBA at 1 meter
Alarm at Medium volume	75 +15/-5 dBA at 1 meter
Alarm at Low volume	65 +15/-5 dBA at 1 meter

O2 Concentrator

Category	Specification
Time to reach set performance	≤3 minutes
Oxygenation limits	90%, nominal
Pressure relief mechanism activation	20±3 PSIG 138±21 kPa

Nebulizer Drive

Category	Specification
Output	12 PSIG +/- 10% up to 8 L/min

FiO2 Monitor

Category	Specification
Time to Essential Performance	5 min
Sample Rate	360 ms (2.78 Hz)
Response Time	≤30 s to 90% of actual
Accuracy	See <i>"Monitor Resolution and Accuracy"</i> on page C-8
Range	15 to 95%, >95%
Drift	0.4% of reading per 10,000 hours of use

Control Accuracy

NOTE: Negative (subatmospheric) pressure is not available during the expiratory phase of ventilation therapy breaths delivered by VOCSN.

NOTE: When used with active, passive, or valveless Ventec One-Circuits, VOCSN was designed for use with a humidifier or HME. All volumes and flows are expressed in BTPS unless stated otherwise.

Control	Accuracy
Apnea Rate	±1 BPM or ±10% of setting, whichever is greater
Breath Rate	Accuracy: ±1 breath/minute, or ±10% of setting, whichever is greater Stability: ±10% of setting
EPAP	See PEEP.
Exsufflation Pressure	±5 cmH ₂ O up to 30 cmH ₂ O ±10 cmH ₂ O over 30 cmH ₂ O
Exsufflation Time	±(10% of setting + 0.1 seconds)
FiO ₂	±10% of setting, or ±3% oxygen, whichever is greater Average delivered FiO ₂ is stable within ±3% oxygen over one hour Time to reach set performance from an external high-pressure oxygen source: ≤5 breaths
Flow	±(10% of setting or 1 L/min, whichever is greater)
Flow Cycle	±10% for active and mouthpiece circuits ±15% for passive and valveless circuits
Flow Trigger	±1 L/min when PEEP is set to 0 cmH ₂ O ±1.5 L/min when PEEP is set to 1 to 6 cmH ₂ O ±2 L/min when PEEP is set to 7 to 16 cmH ₂ O ±2.2 L/min when PEEP is set from 17 to 25 cmH ₂ O
Humidification	N/A
Inspiratory Hold	N/A
Inspiratory Time	Accuracy: ±(10% of setting + 0.1 seconds) Stability: ±(10% of setting + 0.1 seconds)
Insufflation Pressure	±5 cmH ₂ O up to 30 cmH ₂ O ±10 cmH ₂ O over 30 cmH ₂ O
Insufflation Rise Time	N/A
Insufflation Time	±(10% of setting + 0.1 seconds)

Control	Accuracy
IPAP	±(8% of setting or 2 cmH ₂ O, whichever is greater)
Leak Compensation	N/A
Nebulizer Duration	±1 minute
O ₂ Flow Equivalent	Oxygen bolus accuracy: ±(10% of setting or 3 mL, whichever is greater) Percentage oxygen accuracy: 90+6/-3% NOTE: The O ₂ Flow Equivalent control accuracy specifications above apply to VOCSN use within its specified range of environmental operating conditions. See "Environmental" on page 193.
Patient Type	N/A
Pause Time	±(10% of setting + 0.1 seconds)
PC Flow Termination	N/A
PEEP/EPAP	±(10% of setting + 1 cmH ₂ O)
Pressure Control	±(8% of setting or 2 cmH ₂ O, whichever is greater)
Pressure Support	±(8% of setting or 2 cmH ₂ O, whichever is greater)
Rise Time	N/A
Sigh	N/A
Tidal Volume	Measured at the patient connection port Accuracy: ±(10% of setting + 5 mL) for active and mouthpiece circuits; ±(15% of setting + 7.5 mL) for passive and valveless circuits Stability: ±(10% of setting + 5 mL)
Time Cycle	±(10% of setting + 0.1 seconds)
Vacuum	±(10% of setting + 10 mmHg), measured with no flow

Monitor Resolution and Accuracy

NOTE: When used with active, passive, or valveless Ventec One-Circuits, VOCSN was designed for use with a humidifier or HME. All volumes and flows are expressed in BTPS unless stated otherwise.

NOTE: Monitors incorporating pressure measurements are calculated using a pressure sensor inside VOCSN, which calculates the pressure at the Ventec One-Circuit connection port.

NOTE: Unless otherwise stated, monitor accuracy specifications are met when VOCSN is used as recommended by Ventec Life Systems.

Monitor	Resolution	Accuracy
Airway pressure manometer	N/A	±(1.4 cmH ₂ O + 8% of actual) up to 15 cmH ₂ O ±(2 cmH ₂ O + 4% of actual) above 15 cmH ₂ O
Breath Rate	1 BPM	±10% BPM
Calculated FiO ₂	1%	N/A
Concentrator Usage	1 hour	N/A
Cough Cycles	1	N/A
Cough Volume	1 mL	±(20% of actual + 10 mL)
Date	1 day	N/A
FiO ₂	1%	±(2.5% + 2.5% of actual) NOTE: Air contaminants and pollutants (including methane) may have an adverse effect on the accuracy and long-term performance of the FiO ₂ monitor.
I:E Ratio	0.1	Calculated from the average monitored inspiratory time and average monitored exhalation time accuracies of ±50 ms or 5%, whichever is greater
Internal Battery Capacity	N/A	N/A
Leak	1 L/min	±(10% + 1 L/min)
MAP	1 cmH ₂ O	See Airway pressure manometer
Minute Volume	0.1 L when ≤9.9 1.0 L when ≥10	Calculated (for active circuits) or estimated (for passive and valveless circuits) from the average exhaled tidal volume (V _{te}) and number of breaths per minute (BPM) for the last 8 breaths
Nebulizer Minutes Remaining	1 minute	±1 minute
O ₂ Concentrator Usage	1 hour	N/A

Monitor	Resolution	Accuracy
Patient Triggered	N/A	N/A
Peak Cough Flow	1 L/min	$\pm(20\% \text{ of actual} + 5 \text{ L/min of Actual})$
Peak Exhalation Flow	1 L/min	$\pm(15\% + 3 \text{ L/min of actual})$
Peak Inspiratory Flow	1 L/min	$\pm(15\% + 3 \text{ L/min of actual})$
PEEP	1 cmH ₂ O	$\pm(1.4 \text{ cmH}_2\text{O} + 8\% \text{ of actual})$ up to 15 cmH ₂ O $\pm(2 \text{ cmH}_2\text{O} + 4\% \text{ of actual})$ above 15 cmH ₂ O
PIP (Peak Inspiratory Pressure)	1 cmH ₂ O	$\pm(1.4 \text{ cmH}_2\text{O} + 8\% \text{ of actual})$ up to 15 cmH ₂ O $\pm(2 \text{ cmH}_2\text{O} + 4\% \text{ of actual})$ above 15 cmH ₂ O
Plateau Pressure (during Inspiratory Hold)	1 cmH ₂ O	$\pm(2 + 4\% \text{ of reading})$ cmH ₂ O
Pressure (Cough Airway Pressure)	N/A	$\pm(1.4 \text{ cmH}_2\text{O} + 8\% \text{ of actual})$ up to 15 cmH ₂ O $\pm(2 \text{ cmH}_2\text{O} + 4\% \text{ of actual})$ above 15 cmH ₂ O
Pump Usage	1 hour	N/A
Removable Battery 1 Capacity	N/A	N/A
Removable Battery 2 Capacity	N/A	N/A
Static Compliance (during Inspiratory Hold)	1 mL/cmH ₂ O	$\pm(2 + 20\% \text{ of actual value})$ mL/cmH ₂ O for 10 to 100 mL/cmH ₂ O
System Usage	1 hour	N/A
Sys. PM Due In	1 hour	N/A
Time	1 minute	N/A
Vacuum	≤ 10 mmHg (analog visual)	± 25 mmHg while suction is occluded
Vte / Est. Vte	1 mL	$\pm(4.0 \text{ mL [Vtes} > 50 \text{ mL]} \text{ or } 15 \text{ mL [Vtes} \leq 50 \text{ mL]} + 15\% \text{ of actual})$

Classifications

Category	Classification
Electrical Safety	Class II Continuous Portable Internally Powered Transit Operable Type BF Applied Parts
Suction	Medium vacuum / high flow
Applied Parts	Ventec One-Circuit Suction Catheter

Standards Applied

Category	Standard
Critical care ventilators	ISO 80601-2-12
Home care ventilators	ASTM F1246
Breathing sets and connectors	ISO 5367
Oxygen concentrators	ISO 80601-2-69
Respiratory gas monitors	ISO 80601-2-55
Suction	ISO 10079-1
Nebulizing system	ISO 27427
Medical electrical equipment	IEC 60601-1
Alarm system	IEC 60601-1-8
Medical devices for home use	IEC 60601-1-11

Ventec One-Circuit Compliance

NOTE: Based on the set Patient Type and Humidification Type, VOCSN automatically adjusts delivered therapy to compensate for differences in the compliance and volume of the Ventec One-Circuit.

NOTE: The maximum working pressure of Ventec One-Circuits is 70 cmH₂O.

Ventec One-Circuit	Compliance
Adult Ventec One-Circuits	With connected humidifier: 1.4 mL/cmH ₂ O With connected HME: 1.1 mL/cmH ₂ O
Pediatric Ventec One-Circuits	With connected humidifier: 1.0 mL/cmH ₂ O With connected HME: 0.7 mL/cmH ₂ O

Pressure During Inop

VOCSN System	Pressure ¹
Adult	1.66 cmH ₂ O during exhalation at 30 L/min 3.67 cmH ₂ O during inspiration at 30 L/min
Pediatric	0.69 cmH ₂ O during exhalation at 15 L/min 1.38 cmH ₂ O during inspiration at 30 L/min

Biocompatibility

Category	Compliance
Biocompatibility	Meets the requirements of ISO 10993-1 for Tissue/Bone/Dentin Externally Communicating Devices with a permanent contact duration
Volatile Organic Compounds (VOCs) delivered to the patient	<10% of the American Conference of Industrial Hygienists (ACGIH) Threshold Limit Values
Particulate matter delivered to the patient	<12 µg/m ³ per the EPA Fine Particle PM _{2.5} requirements
Allergens	This product is not made with natural rubber latex. No parts of this product that directly or indirectly contact the patient are made with the plasticizer Diethylhexyl phthalate (DEHP).

Accessories

Available from Ventec Life Systems

The following parts and accessories are available for use with VOCSN. Contact your local Ventec Life Systems representative for more information about available components and accessories, or to place an order:







Photo	Item name	Description
	<p>24 Volt Wheelchair Power Cable</p>	<p>The 24 Volt Wheelchair Power Cable can be used to connect VOCSN to wheelchair power outlets.</p>
	<p>AC Power Adapter</p>	<p>10-foot, two-prong AC power cable and 3-foot AC/DC power adapter. The power connector includes a threaded locking mechanism to reduce the risk of accidental disconnects. Wire retention clip ensures the power supply cord remains firmly connected to the adapter. LED on the power adapter indicates proper power connection. The power supply also comes with a hook-and-loop strap to manage excess cabling. This power adapter recharges the three lithium-ion batteries while VOCSN is on or off.</p>
	<p>Carry Bag</p>	<p>The VOCSN Carry Bag supports everyday mobility with an included shoulder strap and multiple attachment points to secure VOCSN to a wheelchair, bed rail, or other mount. The Carry Bag is designed to accommodate full VOCSN functionality while attached. It is compatible with the Roll Stand, Travel Suction Canister, and allows access to both removable, rechargeable batteries.</p>

Photo	Item name	Description
	External Bacterial Filter	The Ventec Bacterial Filter helps to protect both the patient and VOCSN from contamination from airborne microorganisms. The bacterial and viral filtration efficiency (BFE and VFE) is >99.99%.
	External Suction Canister Adapter	The External Suction Canister Adapter connects VOCSN to any third-party external suction canister. The external suction canister adapter includes an internal water-phobic filter that will self-seal to protect VOCSN if the external suction canister overfills.
	Fan Filter	The washable and reusable foam fan filter cleans air entering the cooling fan intake.
	Internal Bacterial Filter	The secondary, low resistance, internal bacterial filter eliminates 99.99% of bacteria and viruses to protect against cross-contamination. Serviceable by trained technicians, typically during 10,000-hour scheduled maintenance. Refer to page 166 for Internal Bacterial Filter replacement instructions.
	Nebulizer Filter	The Nebulizer Filter connects to the VOCSN Nebulizer port. It contains an antimicrobial bacterial filter and an internal water-phobic filter that will self-seal if liquid touches it, protecting VOCSN from damage if liquid travels down the nebulizer tubing.

Photo	Item name	Description
	Nurse Call Cable (Normally Closed - White)	Connects VOCSN to normally closed remote alarm, nurse call, or other alarm systems that sense contact closure through a 1/4 in. (.6 cm) phono jack.
	Nurse Call Cable (Normally Open - Black)	Connects VOCSN to normally open remote alarm, nurse call, or other alarm systems that sense contact closure through a 1/4 in. (.6 cm) phono jack.
	O2 Low-Pressure Inlet Adapter	The O2 Low-Pressure Inlet Adapter inserts into the low-pressure oxygen port on the back of VOCSN to connect to a low-pressure oxygen source.
	Patient Air Intake Filter	This washable and reusable foam filter cleans air entering the patient air intake.
	Removable, Rechargeable Batteries, Lithium-Ion	Set of two lithium-ion 14.4V 5.8Ahr hot-swappable batteries with integrated push button charge indicator. Batteries can be charged in VOCSN or with the detachable battery quick charger. (Battery Quick Charger sold separately.)

Photo	Item name	Description
	Removable Battery Quick Charger	60W desktop charger for two VOCSN detachable batteries. Indicator lights display battery charge status. Each battery charges fully in three hours. The charger is powered by a standard two-prong AC cord. (Batteries not included)
	Roll Stand	The Ventec Roll Stand is a mobile, wheeled mount for VOCSN, and includes a mounting bracket, utility bracket, straps, and a cable hook for cord management.
	Suction Canister Rollstand Holder	The Suction Canister Rollstand Holder easily mounts to the VOCSN Rollstand center pole or drop pole accessory to securely hold third-party suction canisters up to 1,200 mL. A convenient clip holds suction tubing (suction tubing not included).
	Travel Suction Canister	The 300 mL detachable Travel Suction Canister attaches to VOCSN to provide suction therapy on the go. Includes a water-phobic filter that will self seal to protect VOCSN if the Travel Suction Canister overfills.
	USB Drive	VOCSN USB 2.0, FAT32 format.

Photo	Item name	Description
	<p>Ventec One-Circuit, Passive: adult or pediatric, single-patient use</p>	<p>Passive Ventec One-Circuits are single-limb circuits with a fixed-leak passive exhalation port.</p> <p>Adult and pediatric passive Ventec One-Circuits can be purchased with or without the following optional features:</p> <ul style="list-style-type: none"> • Heated wire, used to manage the accumulation of water in the Ventec One-Circuit when connected to a humidifier. • Ventec One-Circuit O2 tube, used to deliver pulse dose Oxygen Direct therapy.
	<p>Ventec One-Circuit, Active: adult or pediatric, single-patient use</p>	<p>Active Ventec One-Circuits are single-limb circuits with an active exhalation valve and proximal flow sensor.</p> <p>Adult and pediatric active Ventec One-Circuits can be purchased with or without the following optional features:</p> <ul style="list-style-type: none"> • Heated wire, used to manage the accumulation of water in the Ventec One-Circuit when connected to a humidifier • Ventec One-Circuit O2 tube, used to deliver pulse dose Oxygen Direct therapy.
	<p>Ventec One-Circuit, Valveless: adult or pediatric, single-patient use</p>	<p>Adult and pediatric Valveless Ventec One-Circuits are single-limb circuits without an exhalation valve for use with vented masks.</p> <p>Adult and pediatric valveless Ventec One-Circuits can be purchased with or without the following optional features:</p> <ul style="list-style-type: none"> • Heated wire, used to manage the accumulation of water in the Ventec One-Circuit when connected to a humidifier.
	<p>Ventec Humidifier Bypass, single-patient use</p>	<p>The Ventec Humidifier Bypass prevents moisture from splashing into VOCSN during Touch Button Cough therapy when using a Ventec One-Circuit connected to a humidifier.</p>

Available from Other Manufacturers

The following third-party components or accessories are approved for use with VOCSN. To ensure proper device performance and patient safety, third-party parts used with VOCSN should meet the requirements listed in the table below

Third-party component or accessory	Requirement for safe use with VOCSN
Closed-Suction Catheter	Compliant with ISO 8836.
Heat-Moisture Exchanger (HME)	Compliant with ISO 9360-1 or ISO 9360-2.
Humidifier	Compliant with ISO 8185. Ventec Life Systems recommends use of the Fisher & Paykel HC550, the Fisher & Paykel MR850, or equivalent.
Mouthpiece Circuit Kit, single-patient use	The Mouthpiece Circuit Kit is a third-party accessory available through Ventec Life Systems. It includes a 15 mm patient circuit, a mouthpiece, flexible extension, connection adapters, and a support arm.
Nebulizer	6 L/min cup compliant with the relevant requirements of ISO 27427.
Open-Suction Catheter	Compliant with ISO 9936.
Suction Tubing	1/4" suction tubing compliant with ISO 10079-1.
Data Streaming Device	Ventec Life Systems recommends use of React DataLink by Bridge-Tech Medical.

EMC Information

The EMC information provided in this chapter applies to VOCSN and its accessories, including the AC Adapter, 24 Volt Wheelchair Power Cable, and Nurse Call Cable.

WARNING: To protect against EMI (electromagnetic interference) affecting device performance:

- Do not use VOCSN within electromagnetic fields exceeding the limits specified in this chapter. Common sources of electromagnetic fields include security systems, wireless communications equipment, appliances, and medical imaging systems.
- Do not stack VOCSN with other electrical devices during use.
- Do not connect VOCSN to unauthorized cables or accessories. Use of cables or other accessories not approved for use with VOCSN may result in increased electromagnetic emissions or decrease its immunity from other sources of EMI.

Electromagnetic Emissions

VOCSN is intended for use in the electromagnetic environment specified below. The user of this device should make sure it is used in such an environment.

Emissions Test	Compliance	Guidance: Electromagnetic Environment
RF emissions CISPR 11	Group 1	VOCSN uses RF energy only for its internal function. Therefore, its RF emissions are very low and are not likely to cause any interference in nearby electronic equipment. VOCSN is suitable for use in all establishments, including domestic establishments and those directly connected to the public low-voltage power supply network that supplies buildings used for domestic purpose.
RF emissions	Class B	
Harmonic emissions IEC 61000-3-2	Class A	
Voltage fluctuations/Flicker emissions IEC 61000-3-3	Complies	

Electromagnetic Immunity

VOCSN is intended for use in the electromagnetic environment specified below. The user of this device should make sure it is used in such an environment.

Immunity Test	IEC 60601 Test Level	Compliance Level	Guidance: Electromagnetic Environment
Electrostatic Discharge (ESD) IEC 61000-4-2	±6 kV contact ±8 kV air	±8 kV contact ± 15 kV air	Floors should be wood, concrete, or ceramic tile. If floors are covered with synthetic material, the relative humidity should be at least 30%.
Electrical fast Transient/burst IEC 61000-4-4	±2 kV for power supply lines ±1 kV for input/output lines	±2 kV for supply mains ±1 kV for input/output lines	Mains power quality should be that of a typical home or hospital environment.
Surge IEC 61000-4-5	±1 kV differential mode ±2 kV common mode	±1 kV differential mode ±2 kV common mode	Mains power quality should be that of a typical home or hospital environment.
Voltage dips, short interruptions, and voltage variations on power supply input lines IEC 61000-4-11	<5% U_T (>95% dip in U_T) for 0.5 cycle 40% U_T (60% dip in U_T) for 5 cycles 70% U_T (30% dip in U_T) for 25 cycles <5% U_T (>95% dip in U_T) for 5 seconds NOTE: U_T is the AC mains voltage prior to application of the test level.	<5% U_T (>95% dip in U_T) for 0.5 cycle 40% U_T (60% dip in U_T) for 5 cycles 70% U_T (30% dip in U_T) for 25 cycles <5% U_T (>95% dip in U_T) for 5 seconds	Mains power quality should be that of a typical home or hospital environment. If the user of the device requires continued operation during power mains interruptions, it is recommended that the device be powered from an uninterruptible power supply or battery.
Power frequency (50/60 Hz) magnetic field IEC 61000-4-8	3 A/m	30 A/m	Power frequency magnetic fields should be at levels characteristic of a typical home or hospital environment.

Immunity Test	IEC 60601 Test Level	Compliance Level	Guidance: Electromagnetic Environment
			Portable and mobile RF communications equipment should be used no closer to any part of the device, including cables, than the recommended separation distance calculated from the equation applicable to the frequency of the transmitter. Recommended separation distance:
Conducted RF IEC 61000-4-6	3 Vrms 150 kHz to 80 MHz outside ISM bands ¹	3 V	$d = 1.2 \sqrt{P}$
	10 Vrms 150 kHz to 80 MHz in ISM bands ^a	10 V	$d = 1.2 \sqrt{P}$

Radiated RF IEC 61000-4-3	10 V/m 80 MHz to 2.5 GHz	20 V/m 80 MHz to 2.5 GHz	$d = 0.6 \sqrt{P}$ 80 MHz to 800 MHz $d = 1.2 \sqrt{P}$ 800 MHz to 2.5 GHz
------------------------------	-----------------------------	-----------------------------	---

where P is the maximum output power rating of the transmitter in watts (W) according to the transmitter manufacturer and d is the recommended separation distance in meters (m).

Field strengths from fixed RF transmitters, as determined by an electromagnetic site survey^a, should be less than the compliance level in each frequency range.²

Interference may occur in the vicinity of equipment marked with the following symbol:



NOTE 1: At 80 MHz and 800 MHz, the higher frequency range applies.

NOTE 2: These guidelines may not apply in all situations. Electromagnetic propagation is affected by absorption and reflection from structures, objects, and people.

¹ Field strengths from fixed transmitters, such as base stations for radio (cellular/cordless) telephones and land mobile radios, amateur radio, AM and FM radio broadcast and TV broadcast cannot be predicted theoretically with accuracy. To assess the electromagnetic environment due to fixed RF transmitters, an electromagnetic site survey should be considered. If the measured field strength in the location in which the device is used exceeds the applicable RF compliance level above, the device should be observed to verify normal operation. If abnormal performance is observed, additional measures may be necessary, such as re-orienting or relocating the device.

² Over the frequency range 150 kHz to 80 MHz, the field strengths should be less than 3 V/m.

Recommended Separation Distance Between Portable and Mobile RF Communications Equipment and VOCSN

VOCSN is intended for use in an electromagnetic environment in which radiated RF disturbances are controlled. The customer or the user of this device can help prevent electromagnetic interference by maintaining a minimum distance between portable and mobile RF communications equipment (transmitters) and this device as recommended below, according to the maximum output power of the communications equipment.

Rated Maximum Power Output of Transmitter (Watts)	Separation Distance According to Frequency of Transmitter (meters)			
	150 kHz to 80 MHz outside ISM Bands $d = 1.2 \sqrt{P}$	150 kHz to 80 MHz in ISM Bands $d = 1.2 \sqrt{P}$	80 MHz to 800 MHz $d = 0.6 \sqrt{P}$	800 MHz to 2.5 GHz $d = 1.2 \sqrt{P}$
0.01	0.12	0.12	0.06	0.12
0.1	0.38	0.38	0.19	0.38
1	1.2	1.2	0.6	1.2
10	3.8	3.8	1.9	3.8
100	12	12	6	12

For transmitters rated at a maximum output power not listed above, the recommended separation distance d in meters (m) can be estimated using the equation applicable to the frequency of the transmitter, where P is the maximum output power of the transmitter manufacturer.

Note 1: At 80 MHz and 800 MHz, the higher frequency range applies.

Note 2: The ISM (industrial, scientific, and medical) bands between 150 kHz and 80 MHz are 6.765 MHz to 6.795 MHz; 13.553 MHz to 13.567 MHz; 26.957 MHz to 27.283 MHz; and 40.66 MHz to 40.70 MHz.

Note 3: An additional factor of $10/3$ is used in calculating the recommended separation distance for transmitters in the ISM frequency bands between 150 kHz and 80 MHz and in the frequency range of 80 MHz and 2.5 GHz to decrease the likelihood that mobile/portable communications equipment could cause interference if it is inadvertently brought into patient areas.

Note 4: These guidelines may not apply in all situations. Electromagnetic propagation is affected by absorption and reflection from structures, objects, and people.

Technical Description

Theory of Operation

The sections that follow detail the theory of operation of each of the five VOCSN therapies. A pneumatic schematic of each therapy is also provided.

Ventilation Therapy and FiO2 Oxygen Therapy

Gas is drawn from the air intake, filtered for dust and particles, and flows into the accumulator. The air is mixed with oxygen if VOCSN is configured to deliver a set FiO2. The accumulator also serves as a muffler for the blower.

The gas passes through the internal flow transducer, which measures flow, and then moves through the blower and through the bacterial filter. Gas flows through the connected patient circuit to deliver the configured Ventilation therapy.

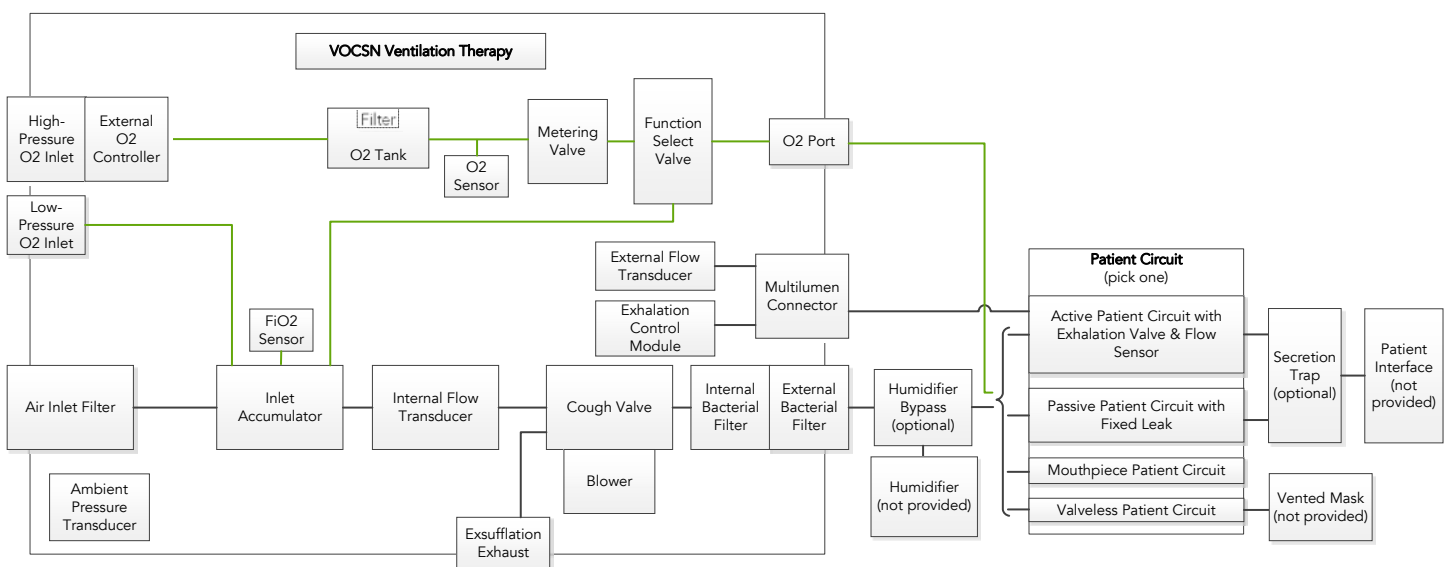

Leak Compensation

With Leak+ hardware configurations, the powerful VOCSN leak compensation algorithm can compensate for leaks up to 175 L/min at 20 cmH₂O. Leak compensation works differently depending on the type of patient circuit and the ventilation mode used. The following table illustrates when VOCSN leak compensation is active. The sections that follow include a detailed description of how leak compensation works with each circuit type.

WARNING: Delivered and monitored ventilation therapy may be affected by large leaks around the patient interface.

Circuit Type	Volume Ventilation (AC-Volume and SIMV-Volume)	Pressure Ventilation (Bi-Level, AC-Pressure, and SIMV-Pressure)	Volume Targeted Ventilation (Vol. Targeted-PS, Vol. Targeted-PC, and Vol Targeted-SIMV)
Active	Delivered volume = No PEEP, Triggering, Monitors, and Waveforms = Yes	Yes	Delivered volume = No PEEP, Triggering, Monitors, and Waveforms = Yes
Passive	Yes	Yes	Yes
Valveless	Yes	Yes	Yes
Mouthpiece	(n/a)	(n/a)	(n/a)

Leak Compensation with an Active Ventec One-Circuit

When set to On, the VOCSN Leak Compensation algorithm runs continuously in the background to calculate and compensate for leaks. VOCSN devices with the Leak+ feature can compensate for large leaks up to 175 L/min at 20 cmH₂O. When VOCSN detects a leak in an active circuit configuration and Leak Compensation is set to On, it compensates by adjusting the following aspects of Ventilation therapy and the monitors:

- Bias flow, to maintain PEEP (also compensated when Leak Compensation is set to Off).
- Pressure breaths, to ensure the pressure at the patient end of the circuit is accurate (also compensated when Leak Compensation is set Off).
- Flow Triggering, to maintain consistent patient effort without autocycling.
- The Vte and Minute Volume monitor, as well as the flow and volume waveforms, to display the actual therapy delivered to the patient.

IMPORTANT NOTE: When used with an active Ventec One-Circuit, VOCSN does not compensate for leaks during volume breaths (including in Volume Targeted ventilation modes). This means that if the Tidal Volume control is set to 500 mL, and there is a 100 mL leak in an active circuit, the patient will receive a tidal volume of 400 mL. Patients with a frequently changing circuit leak (such as patients with an inflated trach tube for only part of the day) who receive volume ventilation may find use of a passive or valveless Ventec One-Circuit more convenient, because of its automatic leak compensation.

Leak Compensation with a Passive or Valveless Ventec One-Circuit

Because passive circuits (and valveless circuits connected to a vented mask) have a fixed and constant leak, VOCSN runs its leak compensation continuously in the background to calculate and compensate for leaks. VOCSN devices with the Leak+ feature can compensate for large leaks up to 175 L/min at 20 cmH₂O. When VOCSN detects a leak in a passive or valveless circuit configuration, it compensates by adjusting the following aspects of Ventilation therapy and the monitors:

- PEEP, to maintain the set pressure for any leak up to 50 L/min @ 10 cmH₂O.
- Volume breaths, to ensure the delivered volume is accurate.
- Pressure breaths, to ensure the pressure at the patient end of the circuit is accurate for any leak up to 50 L/min @ 10 cmH₂O.
- Flow Triggering, to maintain consistent patient effort without autocycling.
- The Estimated V_te and Minute Volume monitor, as well as the flow and volume waveforms, to display the actual therapy delivered to the patient.

Leak Compensation with a Mouthpiece Circuit

Mouthpiece patient circuits are open to ambient air between breaths, and so have a constant large leak. Patients use their mouth to create a seal around the circuit while taking a breath. Because it is unnecessary, leak compensation is not active during Ventilation therapy with a mouthpiece patient circuit.

The Oxygen Direct System

Traditional oxygen concentrators deliver a continuous stream of oxygen in L/min, during both inspiration and exhalation, into the volume of the patient circuit. Using the O₂ Flow Equivalent control, pulse dose Oxygen Direct therapy is delivered through a small oxygen tube inside the Ventec One-Circuit. Pulse dose mode delivers oxygen as a burst of up to 90% oxygen at the beginning of the inspiratory phase of each breath. This allows the internal O₂ Concentrator in VOCSN (or a high-pressure oxygen source) to deliver the targeted oxygen therapy while using less oxygen than traditional delivery methods.

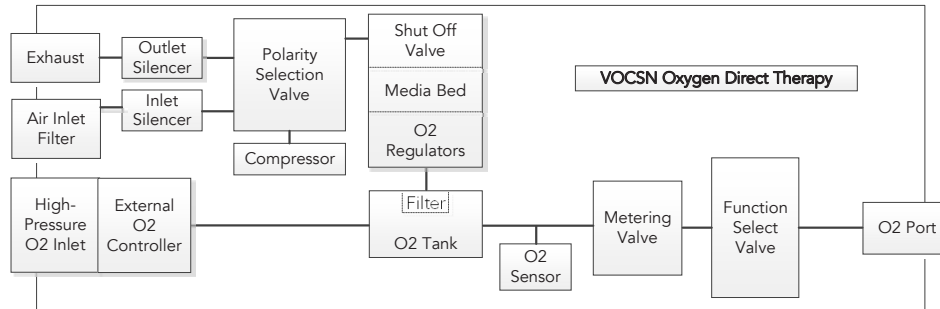

The pulse dose Oxygen Direct delivery method allows the actual oxygen output in L/min to be lower than necessary with traditional oxygen concentrators, while still providing the patient with the targeted FiO₂.

The O₂ Flow Equivalent control allows clinicians to prescribe oxygen using the same prescription in L/min used with traditional concentrators. VOCSN calculates the amount of oxygen to deliver during each breath, equivalent to a continuous stream in L/min.

The following graph describes the relationship between oxygen bolus volume delivered by VOCSN and the patient breath rate at various O₂ Flow Equivalent settings:

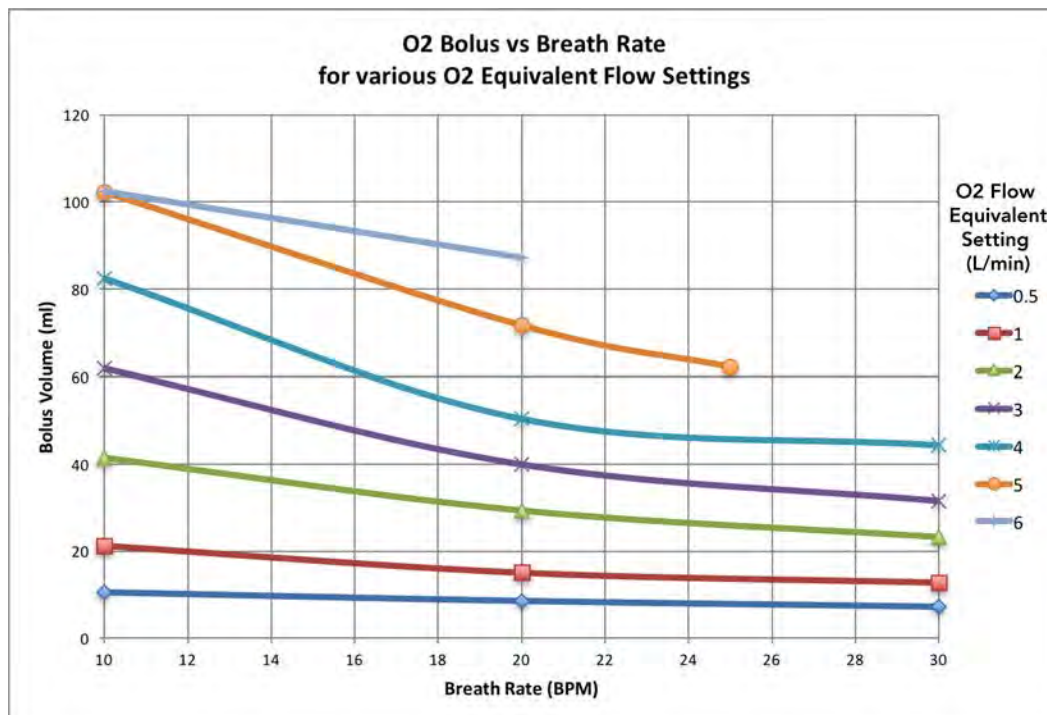

Integrated Cough Assistive Therapy (ICAT) and the Ventec Humidifier Bypass

VOCSN allows the delivery of Cough therapy using the same Ventec One-Circuit used to deliver Ventilation therapy. The Ventec Humidifier Bypass protects VOCSN from potential water damage caused by delivering Cough therapy with an attached humidifier. Because of the high flows generated by VOCSN during Cough exsufflation, water may splash into VOCSN and damage internal components if the humidifier is connected to the Ventec One-Circuit and the Ventec Humidifier Bypass is not used.

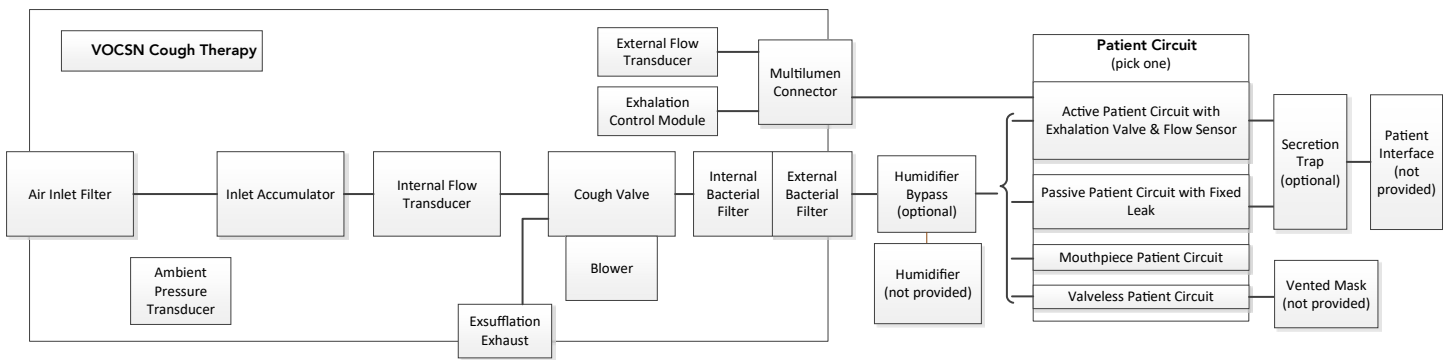

During ventilation or insufflation, the Ventec Humidifier Bypass allows gas to flow from VOCSN, through the humidifier, and to the patient normally. During Cough therapy exsufflation, the Ventec Humidifier Bypass blocks gas from entering the humidifier by routing it from the patient, through the bypass, and away from the device. This prevents water in the humidifier from splashing through the Ventec One-Circuit and damaging VOCSN.

Gas flows from the inlet filter into the blower, which adds energy to the gas stream to achieve the target insufflation pressure. After the insufflation phase, the cough valve changes position and the blower speed increases to achieve the target exsufflation pressure. If configured to do so, the process repeats at the end of a set period of pause.

Suction

The negative pressure produced by VOCSN Suction therapy is measured inside the device. This measurement is displayed on the Suction screen when the therapy is active.

When Suction therapy is activated, gas and secretions are pulled through suction tubing and trapped in an attached suction canister. A hydrophobic filter inside the canister prevents secretions from entering VOCSN. VOCSN controls the pump speed to achieve the target Vacuum setting.

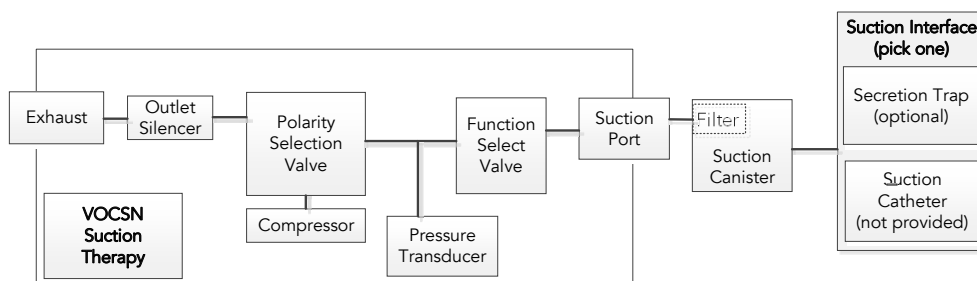

Nebulization

VOCSN can be used to drive a 6 L/min nebulizer cup (+N configurations only), or compensate for the added flow to the patient circuit from an external nebulizer.

Internal Nebulizer Therapy

When activated, the VOCSN nebulization drive produces a constant pressure of 12 PSIG. When connected to most nebulizer cups, this produces a flow of approximately 6 L/min.

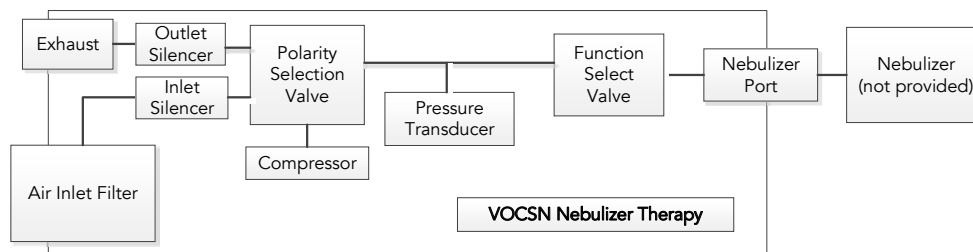

The VOCSN nebulization drive is designed to work with most nebulizer cups, though the flow produced is dependent on the specifications of the nebulizer cup connected to the Ventec One-Circuit. Ensure the nebulizer cup connected to the Ventec One-Circuit is compatible with the VOCSN nebulization drive.

Gas flows from the inlet filter into the VOCSN compressor, and then to the nebulizer. A relief valve prevents back flow from the patient circuit through the nebulizer drive line when the nebulizer is not running.

External Nebulizer Compensation

When External Neb. Comp is on, flow from VOCSN is reduced by 5.9 L/min to compensate for flow from the external nebulizer. The VOCSN monitors also recalculate to reflect the 5.9 L/min of additional flow.

Because the VOCSN FiO₂ monitor measures gas delivered through the device, FiO₂ oxygen delivery during External Neb. Compensation may be higher or lower than monitored by VOCSN, depending on the source driving a connected external nebulizer. If the external nebulizer is driven by air, the FiO₂ to the patient will be lower than the set and monitored FiO₂. If the external nebulizer is driven by oxygen, the FiO₂ to the patient will be higher than the set and monitored FiO₂. If a precise FiO₂ is required during External Neb. Compensation, Ventec Life Systems recommends using an ultrasonic nebulizer instead.

Pulse Dose oxygen delivery during External Neb. Compensation may not be significantly affected for an adult patient when using an external nebulizer driven by air. However, the nebulizer adds deadspace and flow to the patient circuit that may prevent the entire oxygen bolus from reaching patients with small tidal volumes. Therefore, for pediatric patients, the total delivered FiO₂ may be significantly less than the Calculated FiO₂ monitor displayed. If a pediatric patient receiving small Tidal Volumes requires a minimum FiO₂ during nebulizer therapy, Ventec Life Systems recommends using an oxygen source to drive the external nebulizer (which will provide a higher total delivered FiO₂ than the displayed Calculated FiO₂ monitor).

If the patient is oxygen dependent, Ventec Life Systems recommends use of patient oxygen monitoring (e.g., an SpO₂ monitor), especially during nebulization.

VOCSN Measurements

Airway Pressure Measurements

A transducer inside VOCSN takes pressure measurements to help assure the accuracy of delivered breath pressure, including PEEP. VOCSN also contains a second, redundant transducer to ensure accurate, reliable measurements.

The pressure measurements taken by transducers inside VOCSN are then combined with measurements taken while running the Pre-Use Test (to determine the resistance, compliance, and leak of the Ventec One-Circuit). Using these two measurements, VOCSN calculates the airway pressure at the patient interface (mask, tracheal tube, or mouthpiece).

To ensure the set PEEP is maintained when an active circuit is used, the VOCSN leak compensation algorithm detects and compensates for any leaks in the Ventec One-Circuit. Pressure on the back side of the valve allows the active exhalation valve to open when the PEEP setting is reached, ensuring that the set PEEP is not exceeded. When using a passive or valveless circuit, VOCSN calculates and delivers the flow required to reach and maintain the set PEEP.

In addition, Ventec Life Systems recommends the use of appropriate alarms to ensure the accuracy of delivered breath pressure. For example, the High Pressure and Low Inspiratory Pressure alarms, as well as the Low Minute Volume alarm can be set to ensure breaths are accurately delivered during pressure-control ventilation.

NOTE: If the High Pressure and Low Inspiratory Pressure alarms, and/or Low Minute Volume alarms are not set to detect problems with Ventilation therapy, ensure the rest of your alarm suite is configured appropriately to detect any problems with the delivered ventilation.

Flow Measurements

When using a passive or valveless Ventec One-Circuit or mouthpiece patient circuit, VOCSN calculates flows using measurements from its internal transducers and the Pre-Use Test.

When using an active valve, inhalation flows are similarly calculated using measurements from inside VOCSN and from the Pre-Use Test. Flows during exhalation are measured at the active exhalation valve.

Volume Measurements

Exhaled volumes are calculated using measurements from transducers inside VOCSN (or from an active valve), and measurements from the Pre-Use Test.

FiO₂ Measurements

VOCSN includes an integrated FiO₂ monitor, which takes measurements as gas travels to the Ventec One-Circuit connection port.

The Calculated FiO₂ monitor calculates the estimated FiO₂ delivered to the patient, based on VOCSN settings and the patient's breathing patterns. The calculation will change as breathing patterns change, or when VOCSN Ventilation settings are modified.

Alarm Detection Criteria

Alarm	Detection Criteria
O2 Concentration	<ul style="list-style-type: none"> • When gas created by the internal O2 Concentrator is <82% oxygen • When the average O2 accumulator pressure is less than 4 PSI for more than 5±1 minutes while the O2 Flow Equivalent control is active • When a fault is detected with the oxygen flow sensor that measures gas created by the internal O2 Concentrator.
Patient Circuit Disconnect	<p>When High Flow is Off and the Circuit Type control is set to Active, Passive, or Valveless:</p> <ul style="list-style-type: none"> • If Sensitivity is set to "0-75," the alarm activates when the measured leak persists at more than 15.4 L/min/(cmH2O^{0.59}) • If Sensitivity is set to "75-175," the alarm activates when the measured leak persists at more than 30 L/min/(cmH2O^{0.59}) <p>When High Flow is On, when patient breathing of 20 L/min is not detected for more than 20 seconds.</p>
System Fault (all conditions)	<p>If VOCSN detects any of the conditions described in the <i>"System Fault Detection Criteria and Recommended Action"</i> on page 222, the System Fault alarm will activate. Depending on the System Fault condition, some therapies may be suspended or terminated.</p> <p>Use the Event Log to determine the System Fault number. Some System Fault conditions require providing the patient with backup therapy, while others may be resolved by following the recommended actions described below.</p>

System Fault Detection Criteria and Recommended Action

Alarm	Detection Criteria	VOCSN Action	Recommended Action
System Fault 3	When the monitored Cough Airway Pressure is greater than the set Insufflation Pressure plus 20 cmH ₂ O, or the monitored Cough Airway Pressure is less than the set Exsufflation Pressure minus 20 cmH ₂ O.	The current Cough therapy session will terminate and Ventilation therapy will resume.	Ventilation, Oxygen, Suction, and Nebulizer therapies continue functioning normally. Try Cough therapy again. If the problem persists, contact Ventec Life Systems for service.
System Fault 4	When the monitored Suction therapy vacuum exceeds its setting by more than 100 mmHg.	Suction therapy will terminate.	Do not use Suction therapy on the patient. With the suction tubing away from the patient, start suction therapy and occlude the end of the Suction tubing. If the Suction therapy Vacuum monitor is higher than the Vacuum setting, use backup suction equipment and contact Ventec Life Systems for service.
System Fault 6	When positive pressure is generated during Suction therapy.	Suction therapy will terminate.	Do not use Oxygen, Cough, Suction, or Nebulizer therapy on the patient. Provide the patient with backup therapies if necessary. Contact Ventec Life Systems for service.
System Fault 7	When Oxygen, Suction, or Nebulizer therapy output selection fails internal integrity tests.	All three therapies will be suspended.	Try starting Oxygen, Suction, or Nebulizer therapy again. If the problem persists, contact Ventec Life Systems for service.
System Fault 8	When negative pressure is generated during Nebulizer therapy.	The active Nebulizer therapy session will terminate.	Do not use Oxygen, Cough, Suction, or Nebulizer therapy on the patient. Provide the patient with backup therapies if necessary. Contact Ventec Life Systems for service.
System Fault 9	When the Ventilation therapy fan does not turn.	Oxygen concentration, Suction and Nebulizer therapy will be suspended.	Provide the patient with backup Ventilation (and other therapies if necessary). Restart VOCSN. If the problem persists, contact Ventec Life Systems for service.

Alarm	Detection Criteria	VOCSN Action	Recommended Action
System Fault 10	When the redundant transducers in VOCSN detect pressures that differ by >5 cmH ₂ O.	All therapies except Cough will continue to operate using the higher measurement of the two.	Provide the patient with backup Ventilation (and other therapies if necessary). Restart VOCSN. If the problem persists, contact Ventec Life Systems for service.
System Fault 11	When the patient circuit pressure is negative for more than 100 milliseconds during ventilation.	Oxygen concentration, Suction, and Nebulizer therapy will be suspended.	Provide the patient with backup Ventilation (and other therapies if necessary). Restart VOCSN. If the problem persists, contact Ventec Life Systems for service.
System Fault 12	When the monitored Cough Airway Pressure is >80 cmH ₂ O or <-80cmH ₂ O	Cough therapy will be suspended.	Ventilation, Oxygen, Suction, and Nebulizer therapies continue functioning normally. Try Cough therapy again. If the problem persists, contact Ventec Life Systems for service.
System Fault 13	When O ₂ metering fails its integrity checks while Oxygen therapy is active.	No action.	Ventilation, Cough, Suction, and Nebulizer therapies will continue functioning normally. Verify Oxygen therapy is functioning as intended. If the problem persists, contact Ventec Life Systems for service.
System Fault 14	When all VOCSN settings are reset to factory defaults because of a corruption of the stored settings.	Entry of the Clinician Access Passcode is required to reset this condition.	Immediately provide the patient with backup therapy. Enter the Clinician Access Passcode and then manually re-enter all patient settings.
System Fault 15	When the alarm process and/or alarm tones do not activate and are unrecoverable for >30 seconds.	No action.	Immediately provide the patient with backup therapy. Restart VOCSN. If the problem persists, contact Ventec Life Systems for service.

Low-Pressure Oxygen Blending

When using the a low-pressure oxygen source to bleed oxygen into a passive or valveless Ventec One-Circuit, oxygen delivered to the patient may fluctuate based on the following settings and conditions:

- Oxygen flow rate
- Leaks in the Ventec One-Circuit
- Flow Trigger setting
- I:E Ratio setting
- Tidal Volume setting
- Breath Rate
- Pressure Control setting
- Pressure Support setting

The following graphs illustrate the expected FiO₂ based on the patient minute volume when using the FiO₂ control to bleed a low-pressure external oxygen source through VOCSN and into an active Ventec One-Circuit.

NOTE: Increasing the Flow Trigger control setting requires additional oxygen (in L/min) to achieve the target FiO₂. In addition, any leaks in the Ventec One-Circuit will require a higher flow of oxygen input to achieve the target FiO₂.

The following four graphs display the expected FiO₂ with low-pressure O₂ blending at various minute volumes, with an input flow of 93% or 100% O₂, and a Flow Trigger setting of 1 to 3 or 9 L/min. Graphs are also provided for blending during High Flow therapy.

Input Flow 100% Oxygen, Flow Trigger Set to 1-3

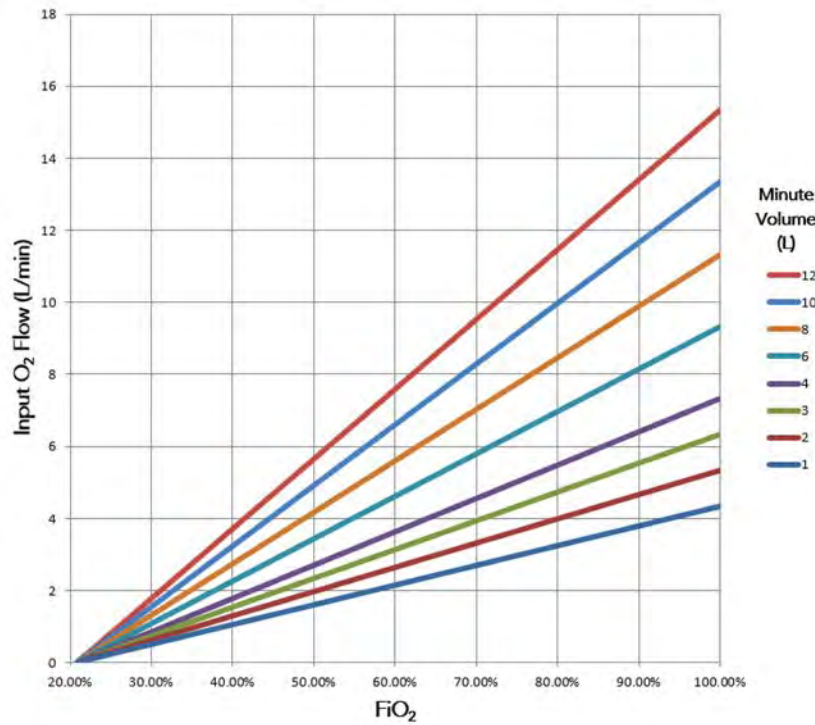

Input Flow 100% Oxygen, Flow Trigger Set to 9

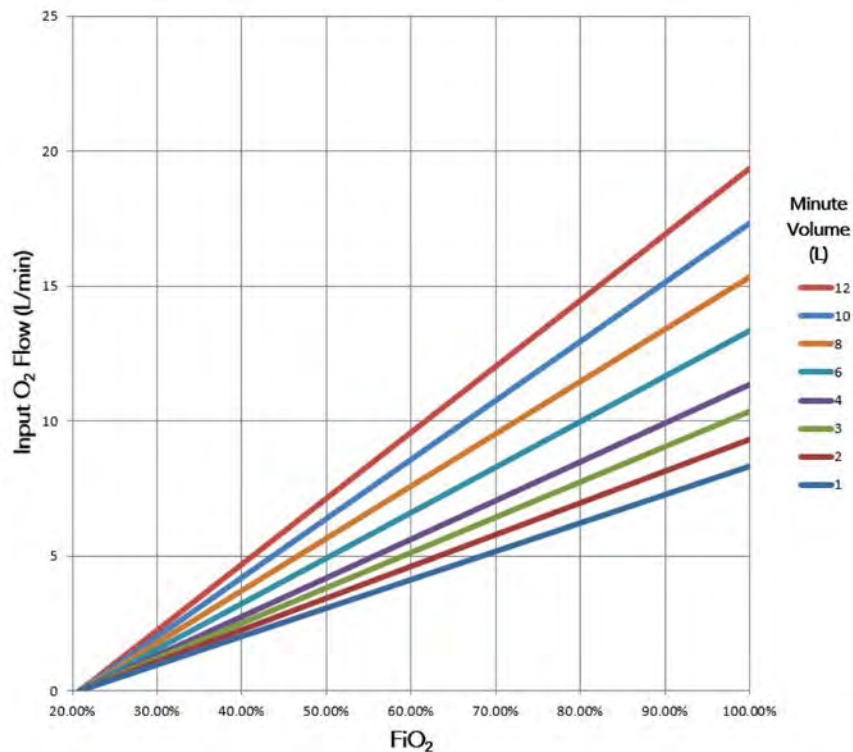

Input Flow 93% Oxygen, Flow Trigger Set to 1-3

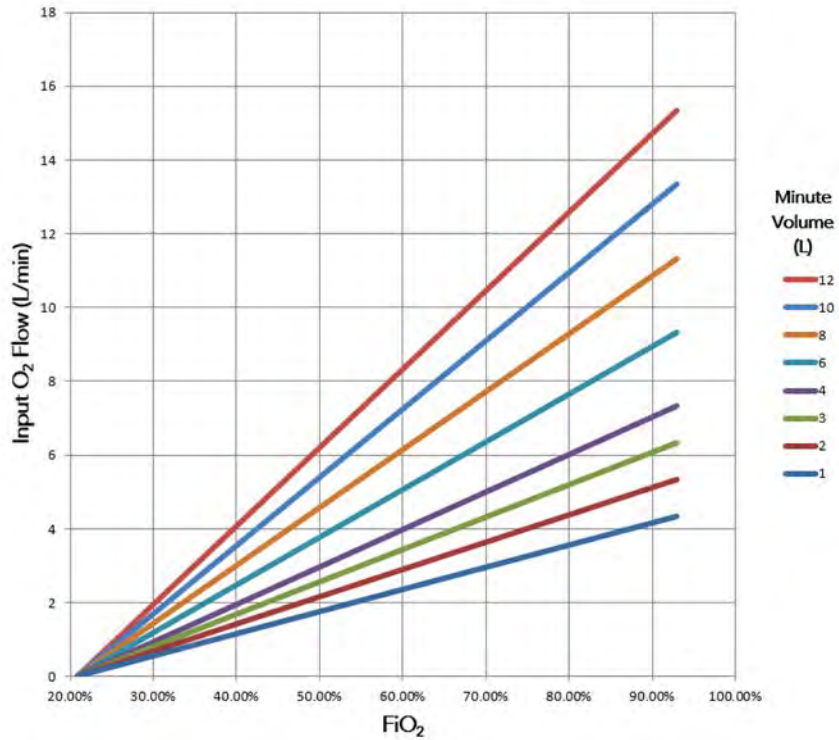

Input Flow 93% Oxygen, Flow Trigger Set to 9

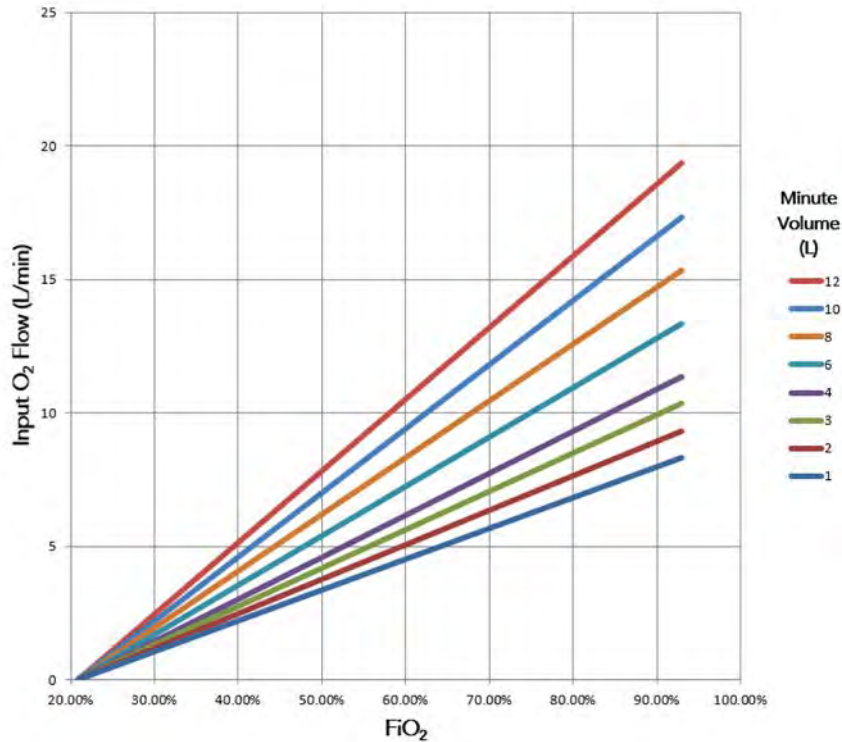

Input Flow 100% Oxygen, High Flow Therapy

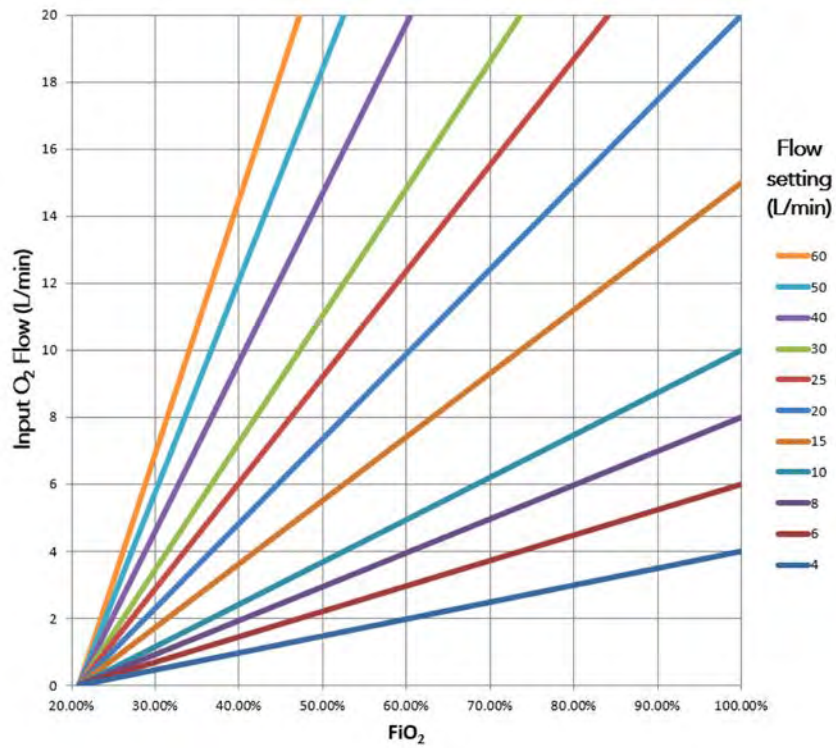

Input Flow 93% Oxygen, High Flow Therapy

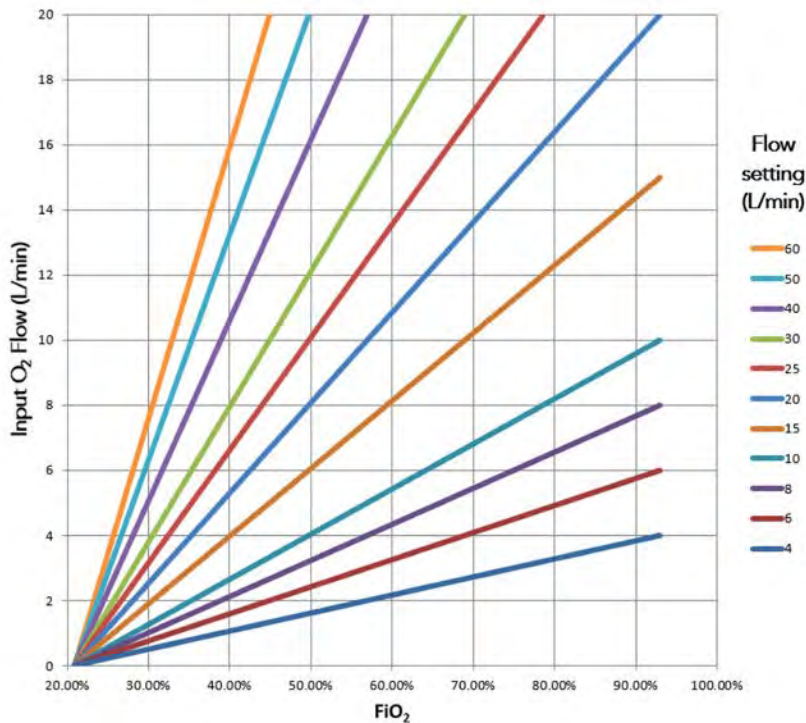



About Ventec Life Systems

Ventec Life Systems is defining integrated respiratory care to improve patient outcomes and reduce caregiver challenges in the hospital and home. Ventec's leading product, VOCSN, seamlessly integrates five separate devices including a ventilator, oxygen concentrator, cough assist, suction, and nebulizer into one unified respiratory system. The team's history of patient-centric design brings care changing innovations to life for patients, medical professionals, and caregivers.

For questions about VOCSN:

VentecLife.com
info@ventecLife.com
1-844-MY-VOCSN

